

1 Soft Skills



①
9

**G. K. Gujar Memorial Charitable Trust's
Dr. Ashok Gujar Technical Institute's
Dr. Daulatrao Aher College of Engineering, Karad**
Accredited by NAAC with B+ & ISO 9001-2008 Certified Institute
Training & Placement Cell

Date: 27/06/2022

TCS- NQT -2023 Batch Orientation Session

All the TY. B.Tech. (All Branches) students are hereby informed to note that, TCS- NQT -2023 Batch Orientation Session is arranged on 28/06/2022, Tuesday at 10:30 am at auditorium.

All the students who are eligible for TCS Placement drive must attend the session as per the schedule.

Points to be Covered in the Session



- TCS Eligibility Criteria
- TCS-NQT-2022- Registration & Application Process
- TCS Test Pattern
- Resume Preparation
- Discussion on Interview Techniques

Note: All the TPCs are requested to inform to their respective branch students and attend the session along with students.

VICE- PRINCIPAL

PRINCIPAL

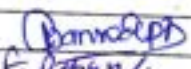
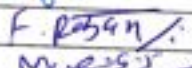
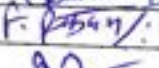
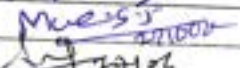
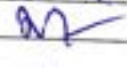
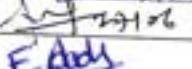
Cc:

Dean Academics		TPO	
HOD-CIVIL		TPC-CIVIL	
HOD- MECH		TPC-MECH	
HOD- ENTC		TPC-ENTC	
HOD-CSE		TPC-CSE	



G. K. Gujar Memorial Charitable Trust's
Dr. Ashok Gujar Technical Institute's
Dr. Daulatrao Aher College of Engineering, Karad
Accredited by NAAC with B+ & ISO 9001-2008 Certified Institute
Training & Placement Cell

Date: 27/06/2022

TCS- NQT -2023 Batch Orientation Session

All the TY. B.Tech. (All Branches) students are hereby informed to note that, TCS- NQT -2023 Batch Orientation Session is arranged on 28/06/2022, Tuesday at 10:30 am at auditorium.

All the students who are eligible for TCS Placement drive must attend the session as per the schedule.

Points to be Covered in the Session

- TCS Eligibility Criteria
- TCS-NQT-2022- Registration & Application Process
- TCS Test Pattern
- Resume Preparation
- Discussion on Interview Techniques

Note: All the TPCs are requested to inform to their respective branch students and attend the session along with students.

VICE- PRINCIPAL

PRINCIPAL

Cc:

Dean Academics		TPO	
HOD-CIVIL		TPC-CIVIL	
HOD- MECH		TPC-MECH	
HOD- ENTC		TPC-ENTC	
HOD-CSE		TPC-CSE	



G. K. Gujar Memorial Charitable Trust's
Dr. Ashok Gujar Technical Institute's
Dr. Daulatrao Aher College of Engineering, Karad
Accredited by NAAC with B+ & ISO 9001-2008 Certified Institute
Training & Placement Cell

Date: 28/06/2022

TCS- NQT -2023 Batch Orientation Session Attendance Sheet

Sr. no	Name of students	Branch	Mob.No.	Eligible for TCS - Y/N	Sign.
1.	Vishakha S. Bansode	Mech	7448247730		<u>V Bansode</u>
2.	Sahil P. Shirwadkar	Mech	992753802		<u>Sahil</u>
3.	Panag P. Salunke	Mech	9595007874		<u>Panag</u>
4.	Akash A. Patil	Mech	9803938372		<u>AK Patil</u>
5.	Mangesh. Thorat	Mech	7709835285		<u>Mangesh</u>
6.	Desai Shubham N	Mech	9765528126		<u>Shubham</u>
7.	Shinde, Rushikesh. S.	Mech	9579779008	Y	<u>Rushikesh</u>
8.	Ramdas. Anuj. H.	Mech	8380883533	Y	<u>AA Ramdas</u>
9.	Shah. Yash. P	Mech	9922523204		<u>Yash</u>
10.	Maske Rajesh B.	Mech	9975135883		<u>Rajesh</u>
11.	Bansode santram S.	Mech	7083669533		<u>Santram</u>
12.	Patil Prakash N	Mech	9139523736		<u>Patil</u>
13.	Deshmukh Arinash M	Mech	7030220302		<u>Arinash</u>
14.					<u>Arinash</u>
15.					
16.					
17.					
18.					
19.					
20.					
21.					
22.					



G. K. Gujar Memorial Charitable Trust's
Dr. Ashok Gujar Technical Institute's
Dr. Daulatrao Aher College of Engineering, Karad
Accredited by NAAC with B+ & ISO 9001-2008 Certified Institute
Training & Placement Cell

Date: 28/06/2022

TCS- NQT -2023 Batch Orientation Session Attendance Sheet

Sr. no	Name of students	Branch	Mob.No.	Eligible for TCS - Y/N	Sign.
1.	Ingavale Rupali Mahadeo	Civil	8668798373	Yes	
2.	Yadav Kinan Mahadeo	Civil	9892334331	Yes	
3.	Kumbhar Abhishek Vishnu	Civil	7387529388	Yes	
4.	Chavan Rushikesh sunil	Civil	7448223717	Yes	
5.	Shekar Prathmesh Boloso	CSE	8657612390		
6.	Mane Uday Sudhir	Entc	9367817587	yes	
7.	Kadam Jaudeep Nathaji	Entc	7709597235	yes	
8.	Bhise Adarsh Dipak	ENTC	7668863025	Yes	
9.					
10.					
11.					
12.					
13.					
14.					
15.					
16.					
17.					
18.					
19.					
20.					
21.					
22.					



G. K. Gujar Memorial Charitable Trust's
Dr. Ashok Gujar Technical Institute's
Dr. Daulatrao Aher College of Engineering, Karad
Accredited by NAAC with B+ & ISO 9001-2008 Certified Institute
Training & Placement Cell

Date: 28/06/2022

TCS- NQT -2023 Batch Orientation Session Attendance Sheet

Sr. no	Name of students	Branch	Mob.No.	Eligible for TCS - Y/N	Sign.
1.	Chavan Divya Raghunath	ENTC	8921728317	Yes	D.R. Chavan
2.	Yadav Sakshi Kuber	ENTC			
3.	Lokare Rutuja Pandurang	ENTC	8554093679	Yes	P. Lokare
4.	Jadhav Nikita Bhagwan	ENTC	8378894288	Yes	J. Jadhav
5.	Shindeshraddha Dattafray	ENTC	9665149606	Yes	S. Shinde
6.	Mahamuni Kalyani Pradeep	ENTC	7397887178	Yes	Mahamuni
7.	Khandogale Dhanashri Chhagan	CSE	7249674690	Yes	Dhanashri
8.	Wangade Kartiki Sanjay	CSE	9067460565	Yes	K. Wangade
9.	Mulla Muskan Tayyabali	CSE	9175658899	Yes	M. Mulla
10.	Sawant Ekta Ravindra	CSE	8668332704	Yes	E. Sawant
11.	Kadam Kajal Chandrakant	CSE	9850130244	Yes	K. Kadam
12.	Kamble Vansha Vinod	ENTC	7040040146		K. Kamble
13.	Pansande Neha Nitin	CSE	7249789306	Yes	N. Pansande
14.	Rupali Mahadky Jagraddha	Civil			
15.	Todkar Reva Uday	ENTC	7875269776		R. Todkar
16.	Jadhav Aditi Uddhav	ENTC	7666115372	Yes	A. Jadhav
17.	Bhagyawant Trunali Manohar	ENTC	7559472797		B. Bhagyawant
18.	Kamble Ankita Rajaram	BNTC	9119412171	Yes	K. Kamble
19.	Kadam Dhanashri Mahadev	ENTC	9359807948	Yes	D. Kadam
20.	Shete Shrawani Hemant	ENTC	7219897004	Yes	S. Shete
21.	Tismare Maithili Vasant	CSE	9061373396	Yes	M. Tismare
22.	Patil Aditya Vishwas	E&TC	7058584156	Yes	A. Patil



G. K. Gujar Memorial Charitable Trust's
Dr. Ashok Gujar Technical Institute's
Dr. Daulatrao Aher College of Engineering, Karad
Accredited by NAAC with B+ & ISO 9001-2008 Certified Institute
Training & Placement Cell

Sr. no	Name of students	Branch	Mob.No.	Eligible for TCS - Y/N	Sign.
23	Karan Ashok Desai	ENTC	983446156	Yes	
24	Khabale Ganesh Ankush	ENTC	7387069194.	Yes	
25	Kadam amkar L.	ENTC	8421725286		
26	Shidruk Omkar Ajendra	ENTC	9766056861	Yes	
27	Mane Uday Sudhir	ENTC	9307817587	Yes	
28	Kadam Jwaldeep Nathaji	ENTC	7709507277	Yes	
29	Khise Adarsh Dipak	ENTC	7666863085	Yes	
30					
31					
32					
33					
34					
35					
36					
37					
38					
39					
40					
41					
42					
43					
44					
45					



G. K. Gujar Memorial Charitable Trust's
Dr. Ashok Gujar Technical Institute's
Dr. Daulatrao Aher College of Engineering, Karad
Accredited by NAAC with B+ & ISO 9001-2008 Certified Institute
Training & Placement Cell

Date: 28/06/2022

TCS- NQT -2023 Batch Orientation Session Attendance Sheet

Sr. no	Name of students	Branch	Mob.No.	Eligible for TCS - Y/N	Sign.
1.	Vaishnavi M. Kshirsagar	CSE	8857087056		Vaishnavi
2.	Vishakha S Bansode	Mech	7448247730		Vishakha
3.	Prushna -S. Santopal	CSE	7821950235	Yes	Prushna
4.	Dipti Suryakant Patil	CSE	8698823160	Yes	D.Patil
5.	Kumbhar Prajkt Kamalakar	CSE	9307362504	Yes	Kumbhar
6.	Tropti suryakant Patil	CSE	8698828161	Yes	Tropti
7.	Mayuri Sanjay Desai	CSE	9870572782	Yes	Desai
8.	Manali Ravikant Jadhav	CSE	8208379145	Yes	Manali
9.	Diksha Rajesh Adsale	CSE	9145247025	Yes	Diksha
10.	Pallavi Kundlik Kabre	CSE	9322488289	Yes	Pallavi
11.	Shinde Mrunali Nanao	CSE	9762830575	Yes	Shinde
12.	Kadum Rohan Sanjay	CSE	9503217630	Yes	Kadum
13.	Pawar Omkar Shrinivas	CSE	7058075931	Yes	Pawar
14.	Mulla Daud Shabbir	CSE	7568706011	Yes	Mulla
15.	Bhosale Prasad Sunil	CSE	9822545182	Yes	Bhosale
16.	Shelar Prathmesh Balasa	CSE	8657612390	Yes	Shelar
17.	Horne Siddhant Dipak	CSE	9604004773	Yes	Horne
18.	Sutar Sohan Dhonaji	C.S.E.	9767160938	Yes	Sutar
19.	Nikam Shubhankar Suresh	CSE	9225831193	Yes	Nikam
20.	More Karan Aban	CSE	7038936357	Yes	More
21.	Suryawanshi Vishwajit Dipak	CSE	9579816391	Yes	Suryawanshi
22.					



G. K. Gujar Memorial Charitable Trust's
Dr. Ashok Gujar Technical Institute's
Dr. Daulatrao Aher College of Engineering, Karad
Accredited by NAAC with B+ & ISO 9001-2008 Certified Institute
Training & Placement Cell

Sr. no	Name of students	Branch	Mob.No.	Eligible for TCS - Y/N	Sign.
23	Gaikwad Anuja Rajendra	CSE	9172352097	Yes	<i>Anuja</i>
24	Jadhav shreya sharad	CSE	7620434340	Yes	<i>shreya</i>
25	Patil Pratiksha Sanjay	CSE	9022607510	Yes	<i>Pratiksha</i>
26	koli Rutuja Anil	CSE	7558676557	Yes	<i>Rutuja</i>
27	Patil Pragati Mahesh	CSE	9834151913	Yes	<i>Patil</i>
28	Shinde Rutuja Prashant	CSE	7709788265	Yes	<i>RShinde</i>
29	Gurav Bhagyshreeshashikant	CSE	8459991695	No.	<i>Gurav S.</i>
30	Arni Dipakkumar Mansuriya	CSE	9421603958	Yes	<i>Arni</i>
31	khandagale dhanstrichhagan	CSE	7249674690	Yes	<i>Dhanstri</i>
32					
33					
34					
35					
36					
37					
38					
39					
40					
41					
42					
43					
44					
45					



SRMIST
SRM Institute of Science and Technology
SRM Institute of Science and Technology
Hearty Welcomes

Slide content (partially visible):

- 1. Introduction
- 2. Objectives
- 3. Scope
- 4. Methodology
- 5. Results
- 6. Conclusion

TCS-NQT-23



(3)
5

**G. K. Gujar Memorial Charitable Trust's
Dr. Ashok Gujar Technical Institute's
Dr. Daulatrao Aher College of Engineering, Karad**
Accredited by NAAC with B+ & ISO 9001-2008 Certified Institute







Date: 12/07/2022

Notice

All the HODs, Deans & faculty members are hereby informed to note that, **"Guidance Session"** by Prof. B. M. Naik, Founder Principal & Prof. P. V. Mandake is arranged on 13/07/2022 at 1:00 pm at Conference Hall. All are informed to attend the session.

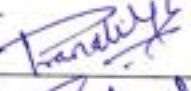
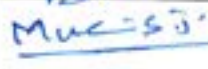
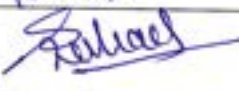
Dr. Anwar M. Mulla
PRINCIPAL

Cc:

Dean- Academic		Dean-IIIC	
Dean- Alumni		Dean- R & D	
HOD - MECH		HOD - CSE	
HOD - EXTC		HOD - CIVIL	
HOD- BSH		NAAC Coordinator	



G. K. Gujar Memorial Charitable Trust's
Dr. Ashok Gujar Technical Institute's
Dr. Daulatrao Aher College of Engineering, Karad
Accredited by NAAC with B+ & ISO 9001-2008 Certified Institute

Date: 13/07/2022

Attendance Sheet

"Guidance Session" by Prof. B. M. Naik, Founder Principal, SGGS Nanded &
Prof. P. V. Mandake sir

Sr. No.	Name of the Faculty Member	Dept.	Sign.
1.	Mrs. Shital P. Kalkade	CSE	
2.	Mr. V.B. Suryawanshi	BSH	
3.	Dr. P.M. Sheth	CSE	
4.	Mr. M.L. Kambhikar	BSH	
5.	Dr. S.S. Nangare	BSH	
6.	Mr. S.D. Bagade	Mech	
7.	Mr. V.V. Rangate	Mech	
8.	Mr. S.J. Mulani	Mech	
9.	Mr. P.D. Bamode	BSH	
10.			
11.			
12.			
13.			
14.			
15.			
16.			
17.			
18.			
19.			
20.			
21.			
22.			
23.			
24.			



Prof. B. M. Naik & Prof. P.V. Mandake



(4)

9

G. K. Gujar Memorial Charitable Trust's
Dr. Ashok Gujar Technical Institute's
Dr. Daulatrao Aher College of Engineering, Karad
Accredited by NAAC with B+ & ISO 9001-2008 Certified Institute
Training & Placement Cell

AGTI's /DACOE/ TPO/2021-2022/

Date: 08/08/2022

Aptitude Training Notice

All the students of **T.Y B.Tech.** batch are hereby informed to note that, we have scheduled **Aptitude Training by Skilllogic, Sangli** for the preparation for upcoming placement drives. Attendance is mandatory for Training.

Start Date: 10/08/2022

Time: 9:30 am to 5:30 pm



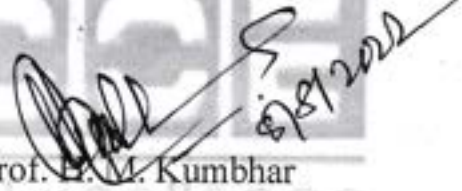

End Date: 14/08/2022

Note: Attendance is compulsory for this training, the student who remains absent for training per day Rs 100 fine will be charged for absent students.

Prof. P.D. Bansode
Training & Placement Officer

Prof. E.M. Kumbhar
VICE- PRINCIPAL

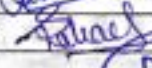
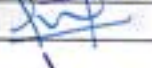
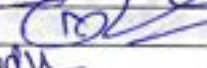
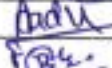
Cc:

Dean- Academic		TPO	
HOD - MECH		HOD - CSE	
HOD - EXTC		HOD - CIVIL	
TPC - MECH		TPC - CSE	
TPC - EXTC		TPC - CIVIL	



Dr. Ashok Gujar Technical Institute's

Dr. Daulatrao Aher College of Engineering, Karad

Aptitude Training for TE - All Branches

Date : 10/08/2022 to 14/08/2022 Venue: Auditorium

Time: 9.30am to 5.30 pm Date:10/08/2022

Sr.No	Complete Name	Mob. No.	Branch	Sign.Session-I	Sign.Session-II
1	Shinde Rushikesh Suhas	9579779008	MECH		
2	Rasika Rajendra Tate		MECH		
3	Hrishikesh Gadve		MECH		
4	Sanket Dilip Deshmane	9370386170	MECH		
5	Pawar Vaishnavi Suryakant		MECH		
6	Prashant Nivas Pawar	9139523736	MECH		
7	Sonali Sunil Sonavale		MECH		
8	Shah Yash Prashant	9922523204	MECH		
9	Bagal Ganesh Suresh	7249764716	MECH		
10	Benzir Jakir Mulla	9284928597	MECH		
11	Sahil Niyaj Mulla		MECH		
12	Muskan Abdul Mulani	8169689092	MECH	Muskan	Muskan
13	Shirwadkar Sahil Pravin.	9921753802	MECH	Sahil	Sahil
14	Kurkute Digvijay Digambar	9673597469	MECH		
15	Wategaonkar Durvesh .S	8081946488	MECH		
16	Ramdasi Anuj .H	8380863533	MECH		
17	Dabhole Mahesh Rajendra	9730626656	MECH		
18	Yadav Prasad .P	9665546302	MECH		
19	Jamdar-Velhal Sarang .S	8459046850	MECH		
20	Desai Atharv .S	7083749174	MECH		
21	Waghmare Viki .S	9834331152	MECH		
22	Lavand Shambhuraj .D	8668210090	MECH		
23	Sathe Sanket Adhikrao	9168221205	MECH		
24	Sankpal Sunil Ravindra	9673012026	MECH		
25	Thombare Rohan Sukhdev	9372928387	MECH		
26	Shikalgar Rais javed	8766456890	MECH		
27	Kalburgi Shivam .B	8308660007	MECH		
28	Attar Azzharuddin .S	7972287600	MECH		
29	Dhumal Akash .A	9689948019	MECH		
30	Gujar Avdhut Jayant	9834476732	MECH		
31	Deshmukh Avinash .M	7030220302	MECH		
32	Desai Shubham Nivas	9765528126	MECH		
33	Dolare Rutik Kundalik	8888267891	MECH		
34	Bhusari Durgesh Sanjay	9370600401	MECH		
35	Jagtap Vishwajit .D	9834387577	MECH		
36	Khandelwal Piyush	9892750221	MECH		
37	Kharade Rohit	9325449132	MECH		

Sr.No	Complete Name	Mob. No.	Branch	Sign.Session-I	Sign.Session-II
38	Jamdar Sujit .D	8600438451	MECH		
39	Pol Akanksha Sanjay	8208366791	MECH		
40	Lagade Priti Anna	9139195520	MECH	<u>PALagade</u>	<u>PALagade</u>
41					
42					
43					
44					
45					
46					
47					
48					
49					
50					
51					
52					
53					
54					
55					
56					
57					
58					
59					
60					
61					
62					
63					
64					
65					
66					
67					
68					
69					
70					
71					
72					
73					
74					
75					
76					
77					
78					
79					
80					



Dr. Ashok Gujar Technical Institute's
Dr. Daulatrao Aher College of Engineering, Karad
Aptitude Training for TE - All Branches
Date : 10/08/2022 to 14/08/2022 Venue: Auditorium
Time: 9.30am to 5.30 pm Date:10/08/2022

Sr.No	Complete Name	Mob. No.	Branch	Sign.Session-I	Sign.Session-II
1	Suyash Ranjitsinh Ghatage		Civil		
2	Chavan Rushikesh Sunil		Civil		
3	Shreya Murlidhar Kamble		Civil		
4	Yadav Kiran Mahadeo	9892334331	Civil		
5	Waghmare Ankita Rajendra		Civil		
6	Priya Shivaji Ingavale		Civil		
7	Mulla Anisahmad Kabirhusen		Civil		
8	Rajput Shreya Yuvrajsing	8600962529	Civil		
9	Monika Mahesh Rathod		Civil		
10	Sagar Ashok Pawar		Civil		
11	Chunnade Shubhada Kedarnath		Civil		
12	Arati Bhiku Jadhav		Civil		
13	Pawar Nitish Rajendra		Civil		
14	Aniket Ananda Bansode		Civil		
15	Garud Priyanka Sanjay		Civil		
16	Ingavale Rupali Mahadev		Civil		
17	Nalawade Vrushali Suraj		Civil		
18	Rohit Sambhaji Mali		Civil		
19	Kumbhar Rohit Ashok		Civil		
20	Rutika Rajendra Pokale	80 07637083	Civil	Ppokale	Ppokale
21	Omkar Rajendra Shinde		Civil		
22	Prerana Shivaji Hattigote		Civil		
23	Shagupta Isak Mutawalli		Civil		
24	Lade Sonal Ghanasham		Civil		
25	More Rahul Sitaram		Civil		
26	Patil Saurabh Subhash	9767977267	Civil	Patil	Patil
27	Sapkal Awadhut Suresh	7387 800930	Civil	Ash	Ash
28					
29					
30					
31					
32					
33					
34					
35					
36					
37					



Dr. Ashok Gujar Technical Institute's
Dr. Daulatrao Aher College of Engineering, Karad
Aptitude Training for TE - All Branches
Date : 10/08/2022 to 14/08/2022 Venue: Auditorium
Time: 9.30am to 5.30 pm Date:10/08/2022

Sr.No	Complete Name	Mob. No.	Branch	Sign.Session-I	Sign.Session-II
1	Rutuja Pandurang Lokare	8554043674	ENTC		
2	Priyanka Tanaji Pawar	9767363159	ENTC		
3	Ankita Rajaram Kamble	9119412171	ENTC		
4	Vaishnavi Dattatray Shivdas		ENTC		
5	Kajal Navnath Mohite	7666770359	ENTC	<u>Kajal Mohite</u>	<u>Kajal Mohite</u>
6	Shraddha Dattatray Shinde	9665149606	ENTC	<u>S.Shinde</u>	<u>S.Shinde</u>
7	Mulla Salina Sameer	9766404813	ENTC		
8	Chavan Pratiksha Ratnakar	9730327563	ENTC		
9	Ayesha Altaf Patel	8080501840	ENTC		
10	Adarsh Dipak Bhise		ENTC	<u>Adarsh</u>	<u>Adarsh</u>
11	Vahagaonkar Kajal Vijay	9613771155	ENTC		
12	Komal Sanjay Chavan		ENTC		
13	Mahamuni Kalyani Pradeep	7397887178	ENTC		
14	Priyanka Vasant Kasar		ENTC		
15	Varsha Vinod Kamble	7040040146	ENTC	<u>Varsha</u>	<u>Varsha</u>
16	Nikita Bhagvan Jadhav	8378894288	ENTC	<u>Nikita</u>	<u>Nikita</u>
17	Shenolkar Vaishnavi Manoj		ENTC		
18	Dhanashri Mahadev Kadam	9359807948	ENTC	<u>D.Kadam</u>	<u>D.Kadam</u>
19	Sakshi Kuber Yadav	9067347823	ENTC		
20	Aditi Uddhav Jadhav	7666115372	ENTC	<u>Aditi</u>	<u>Aditi</u>
21	Komal Sanjay Chavan		ENTC		
22	Kamble Vinay Sunil		ENTC		
23	Shraddha Santosh Kate	9325720027	ENTC		
24	Chavan Divya Raghunath	8421728317	ENTC	<u>D.R.Chavan</u>	<u>D.R.Chavan</u>
25	Shravani Hemant Shete	7219897004	ENTC	<u>Shravani</u>	<u>Shravani</u>
26	Snehal Kalyanrao Ningadale.	7387744886	ENTC	<u>S.K.Ningadale</u>	<u>S.K.Ningadale</u>
27	Saurabh Bhujangrao Patil	7741807080	ENTC		
28	Ganesh Ankush Khabale		ENTC		
29	Aniket Anandrao Chavan	9503675335	ENTC		
30	Vaishnavi Raju Reke		ENTC		
31	Rutuja Vilas Autade	9527760542	ENTC	<u>R.V.Autade</u>	<u>R.V.Autade</u>
32	Misal Shivani Sanjay	7277551222	ENTC		
33	Bhagyawant Mrunali Maruti	7559472797	ENTC		
34	Jadhav Vishwajeet Murlidhar		ENTC		
35	Ganesh Ankush Khabale		ENTC		
36	Bhaldar Ajima Rafik	9175278551	ENTC		
37	Pawar Amruta Vikas	8284111324	ENTC		



Dr. Ashok Gujar Technical Institute's
Dr. Daulatrao Aher College of Engineering, Karad
Aptitude Training for TE - All Branches
Date : 10/08/2022 to 14/08/2022 Venue: Auditorium
Time: 9.30am to 5.30 pm Date:10/08/2022

Sr.No	Complete Name	Mob. No.	Branch	Sign. Session-I	Sign. Session-II
1	Manali Ravikant Jadhav	8208379145	CSE	<u>M Jadhav</u>	<u>M Jadhav</u>
2	Manali Vijay Potdar	7350382359	CSE	<u>M Potdar</u>	<u>M Potdar</u>
3	Vishwajit Dipak Suryawanshi	9579816391	CSE	<u>V S Suryawanshi</u>	<u>V S Suryawanshi</u>
4	Pratiksha Sanjay Patil	9022607510	CSE	<u>P Patil</u>	<u>P Patil</u>
5	Omkar Siddhanath Sawant	9561214133	CSE		
6	Muskan Tayyabali Mulla	9175658899	CSE	<u>M Mulla</u>	<u>M Mulla</u>
7	Kadam Kajal Chandrakant	9850130244	CSE	<u>K C Kadam</u>	<u>K C Kadam</u>
8	Neha Nitin Pansande	7249739306	CSE	<u>N Pansande</u>	<u>N Pansande</u>
9	Karan Abashaheb More	7038936357	CSE	<u>K More</u>	<u>K More</u>
10	Rutuja Anil Koli	7558676557	CSE	<u>R Koli</u>	<u>R Koli</u>
11	Shreya Sayaji Kadam	8767995423	CSE	<u>S Kadam</u>	<u>S Kadam</u>
12	Gharge Pranali	9689515411	CSE		<u>P Gharge</u>
13	Shinde Rutuja Prashant	7709788265	CSE	<u>R P Shinde</u>	<u>R P Shinde</u>
14	Pragati Mahesh Patil	9834151913	CSE	<u>P Patil</u>	<u>P Patil</u>
15	Katre Pallavi Kundlik		CSE		
16	Isha Sandip Bondre	7387790443	CSE	<u>I Bondre</u>	<u>I Bondre</u>
17	Nikita Mukund Adake		CSE		
18	Ghutukade Swapnil Dada		CSE		
19	Kartiki Sanjay Wangade	9067460565	CSE	<u>K Wangade</u>	<u>K Wangade</u>
20	Rutuja Sanjay Kesare	7387913813	CSE	<u>R Kesare</u>	<u>R Kesare</u>
21	Gurav Bhagyashree Shashikant	8459991695	CSE		
22	Sawant Ekta Ravindra	8668332704	CSE	<u>E Sawant</u>	<u>E Sawant</u>
23	Kumbhar Prajкта Kamalakar		CSE		
24	Khandagale Dhanshri Chhagan	7249674690	CSE	<u>D Chhagan</u>	<u>D Chhagan</u>
25	Rohan Sanjay Kadam		CSE		
26	Mrunali Nanaso Shinde	9762830595	CSE	<u>M Shinde</u>	<u>M Shinde</u>
27	Namrata Mahadeo Shinde	7774927171	CSE		
28	Harshada Ashok Tapase	9595111395	CSE		
29	Shreya Sharad Jadhav	7620434340	CSE	<u>S Jadhav</u>	<u>S Jadhav</u>
30	Kumbhar Pooja Uday	7378417599	CSE	<u>P Kumbhar</u>	<u>P Kumbhar</u>
31	Ajinkya Vijay Kumbhar		CSE		
32	Ajinkya Vijay Kumbhar		CSE		
33	Pranali Arun Suryawanshi	9552693272	CSE		
34	Prathmesh Balaso Shelar	8657612390	CSE	<u>P Shelar</u>	<u>P Shelar</u>
35	Yadav Samiksha Ramesh	9504774747	CSE	<u>S Yadav</u>	<u>S Yadav</u>
36	Uday Dnyandev Raje		CSE		
37	Aarya Atul Vaske	7588474474	CSE		

Sr.No	Complete Name	Mob. No.	Branch	Sign. Session-I	Sign. Session-II
38	Mayuri Vikas Yadav	7420841756	CSE	<u>Mayuri</u>	<u>Mayuri</u>
39	Vishwajeet Patil		CSE		
40	Rohit Adhikrao Dange	8485873277	CSE		
41	Mulla Daud Shabbir	7558706011	CSE	<u>D.S.mulla.</u>	<u>D.S.mulla</u>
42	Salunkhe Siddhiraj Dadiram		CSE		
43	Vishwajeet V. Suryawanshi	9527184379	CSE	<u>Vishwajeet</u>	<u>Vishwajeet</u>
44	Rohini Prakash Kumbhar		CSE		
45	Vedanti Mukund Gore	9322468296	CSE	<u>Vedanti</u>	<u>Vedanti</u>
46	Anuja Rajendra Gaikwad	9172352097	CSE	<u>Anuja</u>	<u>Anuja</u>
47	Bhandare Siddesh Panjabrao		CSE		
48	Swaliha Haroon Mulla	9404849650	CSE		
49	Priti Vikas More	7028506092	CSE	<u>Priti</u>	<u>Priti</u>
50	Sohan Sutar	9767160938	CSE		
51	Maithili Vasant Tirmare	9067373396	CSE	<u>Maithili</u>	<u>Maithili</u>
52	Shubhankar Suresh Nikam	9225831193	CSE	<u>Shubhankar</u>	<u>Shubhankar</u>
53	Snehal Ramesh Patil	9665723462	CSE	<u>Snehal</u>	<u>Snehal</u>
54	Rutuja Anil Koli		CSE		
55	Nikita Anil Yadav	7420991333	CSE		
56	Chavan Mayuri Vikas	8554935834	CSE	<u>Mayuri</u>	<u>Mayuri</u>
57	Nikhil Jaywant Ghare	7770030956	CSE		
58	Siddhant Dipak Harne	9604004773	CSE	<u>Siddhant</u>	<u>Siddhant</u>
59	Harshada Ashok Tapase	9595111395	CSE		
60	Sai Vijay Mane	9284088497	CSE		
61	Srushti Mahesh Davadate	9373366465	CSE		
62	Bhosale Prasad Sunil	9822545182	CSE		
63	Bhosale Saurabh .S	9657286931	CSE		
64	Pawar Omkar Shrinivas	7058076931	CSE		
65	Patil Ashwin Babasaheb	8412017271	CSE		
66	Yadav Vipul Vijay	9763492600	CSE		
67	Mansuriya Ami .D	9421603958	CSE	<u>Mansuriya</u>	<u>Mansuriya</u>
68	Patil Trupti Suryakant	8698823161	CSE	<u>Trupti</u>	<u>Trupti</u>
69	Sathe Shilaja .S	8010850378	CSE		
70	Yedage Dhanashri .H	7767910492	CSE		
71	Desai Mayuri Sanjay	9370572782	CSE		
72	Sankpal Trushna Sanjay	7821950235	CSE		
73	Mane Radhika Rajendra	7719894931	CSE		
74	Jadhav Payal Avinash	7249389506	CSE	<u>Payal</u>	<u>Payal</u>
75	Kokane Shraddha .S	8788396702	CSE		
76	Pawar Aishwarya .P	9021031086	CSE	<u>A.P.Pawar</u>	<u>A.P.Pawar</u>
77	Patil Dipti Suryokant	8698823160	CSE	<u>D.Patil</u>	<u>D.Patil</u>
78	Kesare Rutuja Sanjay	7387913813	CSE	<u>R.S.Kesare</u>	<u>R.S.Kesare</u>
79	Diksha Rajesh Adsule	9145247025	CSE	<u>Diksha</u>	<u>Adsule</u>
80					



Dr. Ashok Gujar Technical Institute's
Dr. Daulatrao Aher College of Engineering, Karad
Aptitude Training for TE - All Branches
Date : 10/08/2022 to 14/8/2022 Venue: Auditorium
Time: 9:30 am to 5: 30 p Date: 10/08/2022

Sr.No	Complete Name	Mob. No.	Parents Mob. No.	Branch	Sign.
1	Pooja Uday Kumbhar	7378477599	7620418993	CSE	Pooja
2	Gaikwad Anuja Rajendra	9172352097	8806564153	CSE	Anuja
3	Neha Nitin Pansode	7249739306	7249739306	CSE	Neha
4	Maithili Vasant Tixmate	9061313396	9061313396	CSE	Maithili
5	Manali Vijay Potdar	7350382359	7350385670	CSE	Manali
6	Pratiksha Vijay Patil	9022607110	9921856175	CSE	Pratiksha
7	Priyal Arinash Jadhav	724989506	9921451644	CSE	Priyal
8	Tarushi Suryakant Patil	8698823161	9860270459	CSE	Tarushi
9	Dipti Suryakant Patil	8698823160	9860270459	CSE	Dipti
10	Mulla Muskan Tayyab	9175658899	9623046021	CSE	Mulla
11	Rutuja Anil Kali	7558676557	7758863192	CSE	Rutuja
12	Pragati Mahesh Patil	9834151913	9881657947	CSE	Pragati
13	Ani Dipakkumar Manuniya	9421603958	7020488981	CSE	Ani
14	Shravya Sharad Jadhav	7620434340	9920434340	CSE	Shravya
15	Mulla swalaha Haroon	8767126637	9325551442	CSE	Mulla
16	Katre Pallavi Kundlik	9322488289	9561708404	CSE	Katre
17	Shinde Rutuja Prashant	7709788265	9511815929	CSE	Shinde
18	Kesare Rutuja Sonay	7887913813	9552282939	CSE	Kesare
19	Kadam Shravya Sayaji	8767995423	9970752299	CSE	Kadam
20	Jing			CSE	
21	Sawant Ekta Ravindra	8668332704	9421118773	CSE	Sawant
22	Bondre Isha Sandip	7387790443	9870745704	CSE	Bondre
23	Kadam Kajalchandrakant	9850130244	7263092464	CSE	Kadam
24	Yadav Mayuri Vikas	7420841756	9767689355	CSE	Yadav
25	Yadav Samiksha Ramesh	9504774747	8308992899	CSE	Yadav
26	Patil Snehal Ramesh	9665123402	7620522951	CSE	Patil
27	Diksha Rajesh Advale	9145247025	9652258709	CSE	Diksha
28	Jadhav Manali Ravikant	8208979765	9657645518	CSE	Jadhav
29	Mrunali Nanasa Jhinde	9762830575	9561338710	CSE	Mrunali
30	Shivan Dhanraj Raghunath	9922222222	9922222222	CSE	Shivan
31	Khondogale Dhanshi Dhagan	7249674690	9763125201	CSE	Khondogale
32	Suryawanshi Vishwajeet Vijaykumar	9527164379	9420462063	CSE	Suryawanshi
33	Shelar Prathmesh Balasa	8657612390	7066665439	CSE	Shelar
34	Garware Parth Vivek	9529328167	7387934400	CSE	Garware
35	Sohan Saurav	9767160938		CSE	Sohan
36	Pawar Aishwarya Babush	9021031086	9172491292	CSE	Pawar
37	More Priti Vikas	7028506092	9970771160	CSE	More

Sr.No	Complete Name	Mob. No.	Parents Mob. No.	Branch	Sign.
38	Chavan Mayuri Vikas	8554935834	7028506052	CSE	<i>[Signature]</i>
39	Wangade Kartiki Sanjay	9067460565	7875135424	CSE	<i>[Signature]</i>
40	Singamraoshi Vichrajit Dipak	9579816891	9881968040	CSE	<i>[Signature]</i>
41	Mulla Davud Shabbir	7559706111	9552601470	CSE	<i>[Signature]</i>
42	More Karan Abasaheb	7038936357	7410082001	CSE	<i>[Signature]</i>
43	Nikam Shubhankar Sureb	9225881193	878340619	CSE	<i>[Signature]</i>
44	Bhandare Siddesh Rajendra	8999946264	8905125377	CSE	<i>[Signature]</i>
45					
46					
47					
48					
49					
50					
51					
52					
53					
54					
55					
56					
57					
58					
59					
60					
61					
62					
63					
64					
65					
66					
67					
68					
69					
70					
71					
72					
73					
74					
75					
76					
77					
78					
79					
80					



Dr. Ashok Gujar Technical Institute's
Dr. Daulatrao Aher College of Engineering, Karad
Aptitude Training for TE - All Branches

Date : 10/08/2022 to 14/8/2022 Venue: Auditorium

Time: 9:30 am to 5: 30 p Date: 10/08/2022

Sr.No	Complete Name	Mob. No.	Parents Mob. No.	Branch	Sign.
1	Shravani Hemant Shete	7219897004	7219897004	ENTC	
2	Jadhav Nikita Bhagvan	8378894288	8378894288	ENTC	
3	Kadam Dhonashtri Mahadev	9359807948	9359807948	ENTC	
4	Mohite Kajal Navnath	7666770359	9158237729	ENTC	
5	Autade Rutuja Vilas	9521760542	8308114187	ENTC	
6	Chakar Divya Raghunath	8421728317	9096351670	ENTC	
7	Shinde Shradha Dattatray	9665149606	9485800264	ENTC	
8	Khabale Ganesh Ankush	7387069194		ENTC	
9				ENTC	
10				ENTC	
11				ENTC	
12				ENTC	
13				ENTC	
14				ENTC	
15				ENTC	
16				ENTC	
17				ENTC	
18				ENTC	
19				ENTC	
20				ENTC	
21				ENTC	
22				ENTC	
23				ENTC	
24				ENTC	
25				ENTC	
26				ENTC	
27				ENTC	
28				ENTC	
29				ENTC	
30				ENTC	
31				ENTC	
32				ENTC	
33				ENTC	
34				ENTC	
35				ENTC	
36				ENTC	
37				ENTC	



Dr. Ashok Gujar Technical Institute's
Dr. Daulatrao Aher College of Engineering, Karad
Aptitude Training for TE - All Branches

Date : 10/08/2022 to 14 /8/2022 Venue: Auditorium

Time: 9:30 am to 5: 30 p Date: 10/08/2022

Sr.No	Complete Name	Mob. No.	Parents Mob. No.	Branch	Sign.
1	Priiti. A Lagade	9139195520	7350968555	MECH	P. Lagade
2	Mulani Muskan A	8169689090	9326185299	MECH	M. Aher
3	Kalburgi Shivam B	8308660007	9421659478	MECH	Shivam B
4	Shrawan K. S. P.	9921753802	9921753802	MECH	(S. P.)
5				MECH	
6				MECH	
7				MECH	
8				MECH	
9				MECH	
10				MECH	
11				MECH	
12				MECH	
13				MECH	
14				MECH	
15				MECH	
16				MECH	
17				MECH	
18				MECH	
19				MECH	
20				MECH	
21				MECH	
22				MECH	
23				MECH	
24				MECH	
25				MECH	
26				MECH	
27				MECH	
28				MECH	
29				MECH	
30				MECH	
31				MECH	
32				MECH	
33				MECH	
34				MECH	
35				MECH	
36				MECH	
37				MECH	



Dr. Ashok Gujar Technical Institute's
Dr. Daulatrao Aher College of Engineering, Karad
Aptitude Training for TE - All Branches
Date : 10/08/2022 to 14 /8/2022 Venue: Auditorium
Time: 9:30 am to 5: 30 p Date: 10/08/2022

Sr.No	Complete Name	Mob. No.	Parents Mob. No.	Branch	Sign.
1	Ingaale Poojali M.	8668798373	7715972862	CIVIL	Pooj
2	Piskale Rutika R.	8007637083	9130689704	CIVIL	Piskale
3	Patil Saurabh Subhash	9767977267	9230794322	CIVIL	Patil
4	Sapkai Anandhutsuresh	7387800830	9920243860	CIVIL	Atul
5				CIVIL	
6				CIVIL	
7				CIVIL	
8				CIVIL	
9				CIVIL	
10				CIVIL	
11				CIVIL	
12				CIVIL	
13				CIVIL	
14				CIVIL	
15				CIVIL	
16				CIVIL	
17				CIVIL	
18				CIVIL	
19				CIVIL	
20				CIVIL	
21				CIVIL	
22				CIVIL	
23				CIVIL	
24				CIVIL	
25				CIVIL	
26				CIVIL	
27				CIVIL	
28				CIVIL	
29				CIVIL	
30				CIVIL	
31				CIVIL	
32				CIVIL	
33				CIVIL	
34				CIVIL	
35				CIVIL	
36				CIVIL	
37				CIVIL	



Dr. Ashok Gujar Technical Institute's
Dr. Daulatrao Aher College of Engineering, Karad
Aptitude Training for TE - All Branches
Date : 10/08/2022 to 14/08/2022 Venue: Auditorium
Time: 9.30am to 5.30 pm Date: 11/08/2022

(I)

Sr.No	Complete Name	Mob. No.	Branch	Sign.Session-I	Sign.Session-II
1	Shinde Rushikesh Suhas	9579779008	MECH		
2	Rasika Rajendra Tate		MECH		
3	Hrishikesh Gadve		MECH		
4	Sanket Dilip Deshmane	9370386170	MECH		
5	Pawar Vaishnavi Suryakant	9146991520	MECH	V.Pawar	
6	Prashant Nivas Pawar	9139523736	MECH		
7	Sonali Sunil Sonavale		MECH		
8	Shah Yash Prashant	9922523204	MECH		
9	Bagal Ganesh Suresh	7249764716	MECH		
10	Benzir Jakir Mulla	9284928597	MECH	B.Mulla	
11	Sahil Niyaj Mulla		MECH		
12	Muskan Abdul Mulani	8169689092	MECH	Mulani	Mulani
13	Shirwadkar Sahil Pravin.	9921753802	MECH	Sahil	Sahil
14	Kurkute Digvijay Digambar	9673597469	MECH		
15	Wategaonkar Durvesh .S	8081946488	MECH		
16	Ramdasi Anuj .H	8380863533	MECH		
17	Dabhole Mahesh Rajendra	9730626656	MECH		
18	Yadav Prasad .P	9665546302	MECH		
19	Jamdar-Velhal Sarang .S	8459046850	MECH		
20	Desai Atharv .S	7083749174	MECH		
21	Waghmare Viki .S	9834331152	MECH	Waghmare	Waghmare
22	Lavand Shambhuraj .D	8668210090	MECH		
23	Sathe Sanket Adhikrao	9168221205	MECH		
24	Sankpal Sunil Ravindra	9673012026	MECH		
25	Thombare Rohan Sukhdev	9372928387	MECH		
26	Shikalgar Rais javed	8766456890	MECH		
27	Kalburgi Shivam .B	8308660007	MECH	Kalburgi	Kalburgi
28	Attar Azzharuddin .S	7972287600	MECH	Attar	Attar
29	Dhumal Akash .A	9689948019	MECH	Dhumal	Dhumal
30	Gujar Avdhut Jayant	9834476732	MECH		
31	Deshmukh Avinash .M	7030220302	MECH		
32	Desai Shubham Nivas	9765528126	MECH		
33	Dolare Rutik Kundalik	8888267891	MECH		
34	Bhusari Durgesh Sanjay	9370600401	MECH		
35	Jagtap Vishwajit .D	9834387577	MECH		
36	Khandelwal Piyush	9892750221	MECH		
37	Kharade Rohit	9325449132	MECH		



Dr. Ashok Gujar Technical Institute's
Dr. Daulatrao Aher College of Engineering, Karad
Aptitude Training for TE - All Branches

Date : 10/08/2022 to 14/08/2022 Venue: Auditorium

Time: 9.30am to 5.30 pm Date:11/08/2022

Sr.No	Complete Name	Mob. No.	Branch	Sign.Session-I	Sign.Session-II
1	Suyash Ranjitsinh Ghatage		Civil		
2	Chavan Rushikesh Sunil		Civil		
3	Shreya Murlidhar Kamble		Civil		
4	Yadav Kiran Mahadeo	9892334331	Civil		
5	Waghmare Ankita Rajendra		Civil		
6	Priya Shivaji Ingavale		Civil		
7	Mulla Anisahmad Kabirhusen		Civil		
8	Rajput Shreya Yuvrajsing	8600962529	Civil		
9	Monika Mahesh Rathod		Civil		
10	Sagar Ashok Pawar		Civil		
11	Chunnade Shubhada Kedarnath		Civil		
12	Arati Bhiku Jadhav		Civil		
13	Pawar Nitish Rajendra		Civil		
14	Aniket Ananda Bansode		Civil		
15	Garud Priyanka Sanjay		Civil		
16	Ingavale Rupali Mahadev	8668798373	Civil	pmj	pmj
17	Nalawade Vrushali Suraj		Civil		
18	Rohit Sambhaji Mali		Civil		
19	Kumbhar Rohit Ashok		Civil		
20	Rutika Rajendra Pokale		Civil		
21	Omkar Rajendra Shinde		Civil		
22	Prerana Shivaji Hattigote		Civil		
23	Shagupta Isak Mutawalli		Civil		
24	Lade Sonal Ghanasham		Civil		
25	More Rahul Sitaram		Civil		
26	Patil Saurebh Subhash	9767977807	Civil	Patil	Patil
27	Sapkal Awadhut Sureh	7387800830	Civil	Patil	Patil
28					
29					
30					
31					
32					
33					
34					
35					
36					
37					



Dr. Ashok Gujar Technical Institute's
Dr. Daulatrao Aher College of Engineering, Karad
Aptitude Training for TE - All Branches
Date : 10/08/2022 to 14/08/2022 Venue: Auditorium
Time: 9.30am to 5.30 pm Date:11/08/2022

Sr.No	Complete Name	Mob. No.	Branch	Sign.Session-I	Sign.Session-II
1	Rutuja Pandurang Lokare	8554043674	ENTC		
2	Priyanka Tanaji Pawar	9767363159	ENTC		
3	Ankita Rajaram Kamble	9119412171	ENTC		
4	Vaishnavi Dattatray Shivdas		ENTC		
5	Kajal Navnath Mohite	7666770359	ENTC		
6	Shraddha Dattatray Shinde	9665149606	ENTC	<u>Srshinde</u>	<u>Srshinde</u>
7	Mulla Salina Sameer	9766404813	ENTC		
8	Chavan Pratiksha Ratnakar	9730327563	ENTC		
9	Ayesha Altaf Patel	8080501840	ENTC		
10	Adarsh Dipak Bhise		ENTC		
11	Vahagaonkar Kajal Vijay	9613771155	ENTC		
12	Komal Sanjay Chavan		ENTC		
13	Mahamuni Kalyani Pradeep	7397887178	ENTC		
14	Priyanka Vasant Kasar		ENTC		
15	Varsha Vinod Kamble	7040040146	ENTC	<u>Vkamble</u>	<u>Vkamble</u>
16	Nikita Bhagvan Jadhav	8378894288	ENTC	<u>Njadhav</u>	<u>Njadhav</u>
17	Shenolkar Vaishnavi Manoj		ENTC		
18	Dhanashri Mahadev Kadam	9359807948	ENTC	<u>Dkadam</u>	<u>Dkadam</u>
19	Sakshi Kuber Yadav	9067347823	ENTC		
20	Aditi Uddhav Jadhav	7666115372	ENTC		
21	Komal Sanjay Chavan		ENTC		
22	Kamble Vinay Sunil		ENTC		
23	Shraddha Santosh Kate	9325720027	ENTC		
24	Chavan Divya Raghunath		ENTC		
25	Shravani Hemant Shete	7219897004	ENTC		
26	Snehal Kalyanrao Ningadale.	7387744886	ENTC		
27	Saurabh Bhujangrao Patil	7741807080	ENTC		
28	Ganesh Ankush Khabale		ENTC		
29	Aniket Anandrao Chavan	9503675335	ENTC		
30	Vaishnavi Raju Reke		ENTC		
31	Rutuja Vilas Autade	9527760542	ENTC	<u>Rvautade</u>	<u>Rvautade</u>
32	Misal Shivani Sanjay	7277551222	ENTC		
33	Bhagyawant Mrunali Maruti	7559472797	ENTC		
34	Jadhav Vishwajeet Murlidhar		ENTC		
35	Ganesh Ankush Khabale		ENTC		
36	Bhaldar Ajima Rafik	9175278551	ENTC		
37	Pawar Amruta Vikas	8284111324	ENTC		



Dr. Ashok Gujar Technical Institute's
Dr. Daulatrao Aher College of Engineering, Karad
Aptitude Training for TE - All Branches
Date : 10/08/2022 to 14/08/2022 Venue: Auditorium
Time: 9.30am to 5.30 pm Date:11/08/2022

Sr.No	Complete Name	Mob. No.	Branch	Sign. Session-I	Sign. Session-II
1	Manali Ravikant Jadhav	8208379145	CSE	<u>Madhav</u>	<u>Madhav</u>
2	Manali Vijay Potdar	7350382359	CSE	<u>Madhav</u>	<u>Madhav</u>
3	Vishwajit Dipak Suryawanshi	9579816391	CSE	<u>Suryawanshi</u>	<u>Suryawanshi</u>
4	Pratiksha Sanjay Patil	9022607510	CSE	<u>Patil</u>	<u>Patil</u>
5	Omkar Siddhanath Sawant	9561214133	CSE		
6	Muskan Tayyabali Mulla	9175658899	CSE	<u>Mulla</u>	<u>Mulla</u>
7	Kadam Kajal Chandrakant	9850130244	CSE	<u>K.C.Kadam</u>	<u>K.C.Kadam</u>
8	Neha Nitin Pansande	7249739306	CSE	<u>NNP</u>	<u>NNP</u>
9	Karan Abashaheb More	7038936357	CSE	<u>More</u>	<u>More</u>
10	Rutuja Anil Koli	7558676557	CSE	<u>Koli</u>	<u>Koli</u>
11	Shreya Sayaji Kadam	8767995423	CSE	<u>Kadam</u>	<u>Kadam</u>
12	Gharge Pranali		CSE		
13	Shinde Rutuja Prashant		CSE		
14	Pragati Mahesh Patil	9834151913	CSE	<u>Patil</u>	<u>Patil</u>
15	Katre Pallavi Kundlik	9322458289	CSE	<u>P.Katre</u>	<u>P.Katre</u>
16	Isha Sandip Bondre	7387790443	CSE	<u>Bondre</u>	<u>Bondre</u>
17	Nikita Mukund Adake	9146728122	CSE	<u>Adake</u>	<u>Adake</u>
18	Ghutukade Swapnil Dada		CSE		
19	Kartiki Sanjay Wangade	9067460565	CSE	<u>Wangade</u>	<u>Wangade</u>
20	Rutuja Sanjay Kesare	7387913813	CSE		
21	Gurav Bhagyashree Shashikant	8459991695	CSE		
22	Sawant Ekta Ravindra	8668332704	CSE	<u>Sawant</u>	<u>Sawant</u>
23	Kumbhar Prajta Kamalakar	9307362504	CSE	<u>Kumbhar</u>	<u>Kumbhar</u>
24	Khandagale Dhanshri Chhagan	7249674690	CSE	<u>Dhanshri</u>	<u>Dhanshri</u>
25	Rohan Sanjay Kadam		CSE		
26	Mrunali Nanaso Shinde	9762830575	CSE	<u>Shinde</u>	<u>Shinde</u>
27	Namrata Mahadeo Shinde	7774927171	CSE		
28	Harshada Ashok Tapase	9595111395	CSE		
29	Shreya Sharad Jadhav	7620434340	CSE	<u>Jadhav</u>	<u>Jadhav</u>
30	Kumbhar Pooja Uday		CSE	<u>Kumbhar</u>	<u>Kumbhar</u>
31	Ajinkya Vijay Kumbhar		CSE		
32	Ajinkya Vijay Kumbhar		CSE		
33	Pranali Arun Suryawanshi	9552693272	CSE	<u>Suryawanshi</u>	<u>Suryawanshi</u>
34	Prathmesh Balaso Shelar	8657612390	CSE		
35	Yadav Samiksha Ramesh	9504774747	CSE	<u>Yadav</u>	<u>Yadav</u>
36	Uday Dnyandev Raje		CSE		
37	Aarya Atul Vaske	7588474474	CSE		

Sr.No	Complete Name	Mob. No.	Branch	Sign. Session-I	Sign. Session-II
38	Mayuri Vikas Yadav	7420841756	CSE	Mayuri	Mayuri
39	Vishwajeet Patil		CSE		
40	Rohit Adhikrao Dange	8485873277	CSE		
41	Mulla Daud Shabbir	7558706011	CSE	D.S.mulla	D.S.mulla
42	Salunkhe Siddhiraj Dadiram		CSE		
43	Vishwajeet V. Suryawanshi	9527184379	CSE		
44	Rohini Prakash Kumbhar		CSE		
45	Vedanti Mukund Gore	9322468296	CSE	Gony	Gony
46	Anuja Rajendra Gaikwad	9172352097	CSE	teje	teje
47	Bhandare Siddesh Panjabrao		CSE		
48	Swaliha Haroon Mulla	9404849650	CSE	S.mulla	S.mulla
49	Priti Vikas More	7028506092	CSE	Phony	Phony
50	Sohan Sutar	9767160938	CSE		
51	Maithili Vasant Tirmare	9067373396	CSE		
52	Shubhankar Suresh Nikam	9225831193	CSE	Nikam	Nikam
53	Snehal Ramesh Patil	9665723462	CSE		
54	Rutuja Anil Koli		CSE		
55	Nikita Anil Yadav	7420991333	CSE	Mayuri	Mayuri
56	Chavan Mayuri Vikas	8554935834	CSE		
57	Nikhil Jaywant Ghare	7770030956	CSE		
58	Siddhant Dipak Harne	9604004773	CSE		
59	Harshada Ashok Tapase	9595111395	CSE		
60	Sai Vijay Mane	9284088497	CSE		
61	Srushti Mahesh Davadate	9373366465	CSE		
62	Bhosale Prasad Sunil	9822545182	CSE	Bhosale	
63	Bhosale Saurabh .S	9657286931	CSE		
64	Pawar Omkar Shrinivas	7058076931	CSE		
65	Patil Ashwin Babasaheb	8412017271	CSE		
66	Yadav Vipul Vijay	9763492600	CSE		
67	Mansuriya Ami .D	9421603958	CSE	Ami	Ami
68	Patil Trupti Suryakant	8698823161	CSE	Trupti	Trupti
69	Sathe Shilaja .S	8010850378	CSE		
70	Yedage Dhanashri .H	7767910492	CSE		
71	Desai Mayuri Sanjay	9370572782	CSE	Desai	Desai
72	Sankpal Trushna Sanjay	7821950235	CSE		
73	Mane Radhika Rajendra	7719894931	CSE		
74	Jadhav Payal Avinash	7249389506	CSE	Rade	Rade
75	Kokane Shraddha .S	8788396702	CSE		
76	Pawar Aishwarya .P	9021031086	CSE	Pawar	Pawar
77	Patil Dipti Suryakant	8698823160	CSE	Patil	Patil
78	Diksha Rajesh Adale	9145247025	CSE	Adale	Adale
79					
80					



Dr. Ashok Gujar Technical Institute's
Dr. Daulatrao Aher College of Engineering, Karad
Aptitude Training for TE - All Branches
Date : 10/08/2022 to 14/08/2022 Venue: Auditorium
Time: 9.30am to 5.30 pm Date:12/08/2022

Sr.No	Complete Name	Mob. No.	Branch	Sign.Session-I	Sign.Session-II
1	Shinde Rushikesh Suhas	9579779008	MECH		
2	Rasika Rajendra Tate		MECH		
3	Hrishikesh Gadve		MECH		
4	Sanket Dilip Deshmane	9370386170	MECH	<u>Sanket</u>	
5	Pawar Vaishnavi Suryakant		MECH		
6	Prashant Nivas Pawar	9139523736	MECH		
7	Sonali Sunil Sonavale		MECH		
8	Shah Yash Prashant	9922523204	MECH		
9	Bagal Ganesh Suresh	7249764716	MECH		
10	Benzir Jakir Mulla	9284928597	MECH		
11	Sahil Niyaj Mulla		MECH		
12	Muskan Abdul Mulani	8169689092	MECH	<u>Mulani</u>	<u>Mulani</u>
13	Shirwadkar Sahil Pravin.	9921753802	MECH	<u>Sahil</u>	<u>Sahil</u>
14	Kurkute Digvijay Digambar	9673597469	MECH		
15	Wategaonkar Durvesh .S	8081946488	MECH		
16	Ramdasi Anuj .H	8380863533	MECH		
17	Dabhole Mahesh Rajendra	9730626656	MECH		
18	Yadav Prasad .P	9665546302	MECH		
19	Jamdar-Velhal Sarang .S	8459046850	MECH		
20	Desai Atharv .S	7083749174	MECH		
21	Waghmare Viki .S	9834331152	MECH	<u>W</u>	<u>W</u>
22	Lavand Shambhuraj .D	8668210090	MECH		
23	Sathe Sanket Adhikrao	9168221205	MECH		
24	Sankpal Sunil Ravindra	9673012026	MECH		
25	Thombare Rohan Sukhdev	9372928387	MECH		
26	Shikalgar Rais javed	8766456890	MECH		
27	Kalburgi Shivam .B	8308660007	MECH	<u>Kalburgi</u>	
28	Attar Azzharuddin .S	7972287600	MECH		
29	Dhumal Akash .A	9689948019	MECH		
30	Gujar Avdhut Jayant	9834476732	MECH		
31	Deshmukh Avinash .M	7030220302	MECH		
32	Desai Shubham Nivas	9765528126	MECH		
33	Dolare Rutik Kundalik	8888267891	MECH		
34	Bhusari Durgesh Sanjay	9370600401	MECH		
35	Jagtap Vishwajit .D	9834387577	MECH		
36	Khandelwal Piyush	9892750221	MECH		
37	Kharade Rohit	9325449132	MECH		



Dr. Ashok Gujar Technical Institute's
Dr. Daulatrao Aher College of Engineering, Karad
Aptitude Training for TE - All Branches
Date : 10/08/2022 to 14/08/2022 Venue: Auditorium
Time: 9.30am to 5.30 pm Date:12/08/2022

Sr.No	Complete Name	Mob. No.	Branch	Sign.Session-I	Sign.Session-II
1	Suyash Ranjitsinh Ghatage		Civil		
2	Chavan Rushikesh Sunil		Civil		
3	Shreya Murlidhar Kamble		Civil	Shreya Kamble	Shreya Kamble
4	Yadav Kiran Mahadeo	9892334331	Civil	Yadav	Yadav
5	Waghmare Ankita Rajendra		Civil		
6	Priya Shivaji Ingavale		Civil		
7	Mulla Anisahmad Kabirhusen		Civil		
8	Rajput Shreya Yuvrajsing	8600962529	Civil		
9	Monika Mahesh Rathod		Civil		
10	Sagar Ashok Pawar		Civil		
11	Chunnade Shubhada Kedarnath		Civil		
12	Arati Bhiku Jadhav		Civil		
13	Pawar Nitish Rajendra		Civil		
14	Aniket Ananda Bansode		Civil		
15	Garud Priyanka Sanjay		Civil		
16	Ingavale Rupali Mahadev	8668798373	Civil	Rupali	Rupali
17	Nalawade Vrushali Suraj		Civil	Rupali	Rupali
18	Rohit Sambhaji Mali		Civil		
19	Kumbhar Rohit Ashok		Civil		
20	Rutika Rajendra Pokale	8007637083	Civil	Rpokale	Rpokale
21	Omkar Rajendra Shinde		Civil		
22	Prerana Shivaji Hattigote		Civil		
23	Shagupta Isak Mutawalli		Civil		
24	Lade Sonal Ghanasham		Civil		
25	More Rahul Sitaram		Civil		
26	Patil Saurabh Subhash	9767977867	Civil	Patil	Patil
27	Sarkar Anandhuf Sursh	738780070	Civil	Sursh	Sursh
28	Surme Saurabh Shitbol	7720912264	Civil		Surme
29					
30					
31					
32					
33					
34					
35					
36					
37					



Dr. Ashok Gujar Technical Institute's
Dr. Daulatrao Aher College of Engineering, Karad
Aptitude Training for TE - All Branches
Date : 10/08/2022 to 14/08/2022 Venue: Auditorium
Time: 9.30am to 5.30 pm Date:12/08/2022

Sr.No	Complete Name	Mob. No.	Branch	Sign.Session-I	Sign.Session-II
1	Rutuja Pandurang Lokare	8554043674	ENTC	<u>R Lokare</u>	<u>R Lokare</u>
2	Priyanka Tanaji Pawar	9767363159	ENTC		
3	Ankita Rajaram Kamble	9119412171	ENTC		
4	Vaishnavi Dattatray Shivdas		ENTC		
5	Kajal Navnath Mohite	7666770359	ENTC		
6	Shraddha Dattatray Shinde	9665149606	ENTC	<u>Shinde</u>	<u>Shinde</u>
7	Mulla Salina Sameer	9766404813	ENTC		
8	Chavan Pratiksha Ratnakar	9730327563	ENTC		
9	Ayesha Altaf Patel	8080501840	ENTC		
10	Adarsh Dipak Bhise		ENTC		
11	Vahagaonkar Kajal Vijay	9613771155	ENTC	<u>Vahagaonkar</u>	<u>Vahagaonkar</u>
12	Komal Sanjay Chavan		ENTC	<u>Chavan</u>	<u>Chavan</u>
13	Mahamuni Kalyani Pradeep	7397887178	ENTC		
14	Priyanka Vasant Kasar		ENTC		
15	Varsha Vinod Kamble	7040040146	ENTC	<u>Varsha</u>	<u>Varsha</u>
16	Nikita Bhagvan Jadhav	8378894288	ENTC	<u>Nikita</u>	<u>Nikita</u>
17	Shenolkar Vaishnavi Manoj		ENTC		
18	Dhanashri Mahadev Kadam	9359807948	ENTC	<u>D Kadam</u>	<u>D Kadam</u>
19	Sakshi Kuber Yadav	9067347823	ENTC	<u>Sakshi</u>	<u>Sakshi</u>
20	Aditi Uddhav Jadhav	7666115372	ENTC	<u>Aditi</u>	<u>Aditi</u>
21	Komal Sanjay Chavan		ENTC		
22	Kamble Vinay Sunil		ENTC		
23	Shraddha Santosh Kate	9325720027	ENTC	<u>Kate</u>	
24	Chavan Divya Raghunath	8421728317	ENTC	<u>D.R.Chavan</u>	<u>D.R.Chavan</u>
25	Shravani Hemant Shete	7219897004	ENTC	<u>Shete</u>	<u>Shete</u>
26	Snehal Kalyanrao Ningadale.	7387744886	ENTC	<u>S.K.Ningadale</u>	<u>S.K.Ningadale</u>
27	Saurabh Bhujangrao Patil	7741807080	ENTC		
28	Ganesh Ankush Khabale	7387069194	ENTC	<u>Ghabale</u>	<u>Ghabale</u>
29	Aniket Anandrao Chavan	9503675335	ENTC		
30	Vaishnavi Raju Reke		ENTC		
31	Rutuja Vilas Autade	9527760542	ENTC	<u>Autade</u>	<u>Autade</u>
32	Misal Shivani Sanjay	7277551222	ENTC		
33	Bhagyawant Mrunali Maruti	7559472797	ENTC	<u>Bhagyawant</u>	
34	Jadhav Vishwajeet Murlidhar		ENTC		
35	Ganesh Ankush Khabale		ENTC		
36	Bhaldar Ajima Rafik	9175278551	ENTC		
37	Pawar Amruta Vikas	8284111324	ENTC		

Sr.No	Complete Name	Mob. No.	Branch	Sign.Session-I	Sign.Session-II
38	Todkar Reva Uday	7875269776	ENTC	<u>Rtodkar</u>	<u>Rtodkar</u>
39	Ashil shambhurg) c	724938400	ENTC	<u>SPAH</u>	<u>SPAH</u>
40	omkar kadam		ENTC	<u>okadam</u>	<u>okadam</u>
41					
42					
43					
44					
45					
46					
47					
48					
49					
50					
51					
52					
53					
54					
55					
56					
57					
58					
59					
60					
61					
62					
63					
64					
65					
66					
67					
68					
69					
70					
71					
72					
73					
74					
75					
76					
77					
78					
79					
80					





Dr. Ashok Gujar Technical Institute's
Dr. Daulatrao Aher College of Engineering, Karad
Coding Training for TE - All Branches

mec = 9

Date : 10/08/2022 to 14/08/2022 Venue: Auditorium

Time: 9.30am to 5.30 pm Date:13/08/2022

Sr.No	Complete Name	Mob. No.	Branch	Sign.Session-I	Sign.Session-II
1	Shinde Rushikesh Suhas	9579779008	MECH		
2	Rasika Rajendra Tate		MECH		
3	Hrishikesh Gadve		MECH		
4	Sanket Dilip Deshmane	9370386170	MECH		
5	Pawar Vaishnavi Suryakant	9146991520	MECH	<i>V.Pawar</i>	
6	Prashant Nivas Pawar	9139523736	MECH		
7	Sonali Sunil Sonavale		MECH		
8	Shah Yash Prashant	9922523204	MECH		
9	Bagal Ganesh Suresh	7249764716	MECH		
10	Benzir Jakir Mulla	9284928597	MECH	<i>B.J.Mulla</i>	
11	Sahil Niyaj Mulla		MECH		
12	Muskan Abdul Mulani	8169689092	MECH	<i>M.A.Mulani</i>	<i>M. Amulani</i>
13	Shirwadkar Sahil Pravin.	9921753802	MECH	<i>Sahil</i>	
14	Kurkute Digvijay Digambar	9673597469	MECH		
15	Wategaonkar Durvesh .S	8081946488	MECH		
16	Ramdasi Anuj .H	8380863533	MECH		
17	Dabhole Mahesh Rajendra	9730626656	MECH		
18	Yadav Prasad .P	9665546302	MECH		
19	Jamdar-Velhal Sarang .S	8459046850	MECH		
20	Desai Atharv .S	7083749174	MECH		
21	Waghmare Viki .S	9834331152	MECH	<i>Viki</i>	
22	Lavand Shambhuraj .D	8668210090	MECH		
23	Sathe Sanket Adhikrao	9168221205	MECH		
24	Sankpal Sunil Ravindra	9673012026	MECH		
25	Thombare Rohan Sukhdev	9372928387	MECH		
26	Shikalgar Rais javed	8766456890	MECH		
27	Kalburgi Shivam .B	8308660007	MECH	<i>Shivam</i>	
28	Attar Azzharuddin .S	7972287600	MECH		
29	Dhumal Akash .A	9689948019	MECH		
30	Gujar Avdhut Jayant	9834476732	MECH		
31	Deshmukh Avinash .M	7030220302	MECH		
32	Desai Shubham Nivas	9765528126	MECH		
33	Dolare Rutik Kundalik	8888267891	MECH		
34	Bhusari Durgesh Sanjay	9370600401	MECH		
35	Jagtap Vishwajit .D	9834387577	MECH		
36	Khandelwal Piyush	9892750221	MECH		
37	Kharade Rohit	9325449132	MECH		

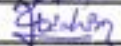
Sr.No	Complete Name	Mob. No.	Branch	Sign.Session-I	Sign.Session-II
38	Jamdar Sujit .D	8600438451	MECH		
39	Pol Akanksha Sanjay	8208366791	MECH		
40	Lagade Priti Anna	9139195520	MECH		
41	Bagwan m.saad jadhav	8408093025	MECH		
42	Sayyad Pich Ibrahim	7558888620	MECH		
43					
44					
45					
46					
47					
48					
49					
50					
51					
52					
53					
54					
55					
56					
57					
58					
59					
60					
61					
62					
63					
64					
65					
66					
67					
68					
69					
70					
71					
72					
73					
74					
75					
76					
77					
78					
79					
80					



Dr. Ashok Gujar Technical Institute's
Dr. Daulatrao Aher College of Engineering, Karad
Coding Training for TE - All Branches
Date : 10/08/2022 to 14/08/2022 Venue: Auditorium
Time: 9.30am to 5.30 pm Date:13/08/2022

Civil = 2

Sr.No	Complete Name	Mob. No.	Branch	Sign.Session-I	Sign.Session-II
1	Suyash Ranjitsinh Ghatage		Civil		
2	Chavan Rushikesh Sunil		Civil		
3	Shreya Murlidhar Kamble		Civil		
4	Yadav Kiran Mahadeo	9892334331	Civil		
5	Waghmare Ankita Rajendra		Civil		
6	Priya Shivaji Ingavale		Civil		
7	Mulla Anisahmad Kabirhusen		Civil		
8	Rajput Shreya Yuvrajsing	8600962529	Civil		
9	Monika Mahesh Rathod		Civil		
10	Sagar Ashok Pawar		Civil		
11	Chunnade Shubhada Kedarnath		Civil		
12	Arati Bhiku Jadhav		Civil		
13	Pawar Nitish Rajendra		Civil		
14	Aniket Ananda Bansode		Civil		
15	Garud Priyanka Sanjay		Civil		
16	Ingavale Rupali Mahadev	8668798373	Civil	fm	fmj
17	Nalawade Vrushali Suraj		Civil		
18	Rohit Sambhaji Mali		Civil		
19	Kumbhar Rohit Ashok		Civil		
20	Rutika Rajendra Pokale		Civil		
21	Omkar Rajendra Shinde		Civil		
22	Prerana Shivaji Hattigote		Civil		
23	Shagupta Isak Mutawalli		Civil		
24	Lade Sonal Ghanasham		Civil		
25	More Rahul Sitaram		Civil		
26	Patil Saurabh Subhash	9707977009	Civil	Patil	Patil
27					
28					
29					
30					
31					
32					
33					
34					
35					
36					
37					



Dr. Ashok Gujar Technical Institute's
Dr. Daulatrao Aher College of Engineering, Karad
Coding Training for TE - All Branches
Date : 10/08/2022 to 14/08/2022 Venue: Auditorium
Time: 9.30am to 5.30 pm Date:13/08/2022

Entc = 13

Sr.No	Complete Name	Mob. No.	Branch	Sign.Session-I	Sign.Session-II
1	Rutuja Pandurang Lokare	8554043674	ENTC		
2	Priyanka Tanaji Pawar	9767363159	ENTC		
3	Ankita Rajaram Kamble	9119412171	ENTC		
4	Vaishnavi Dattatray Shivdas		ENTC		
5	Kajal Navnath Mohite	7666770359	ENTC	<i>K Mohite</i>	<i>K Mohite</i>
6	Shraddha Dattatray Shinde	9665149606	ENTC	<i>SD Shinde</i>	<i>SD Shinde</i>
7	Mulla Salina Sameer	9766404813	ENTC	<i>S.S.Mulla</i>	<i>SS-Mulla</i>
8	Chavan Pratiksha Ratnakar	9730327563	ENTC		
9	Ayesha Altaf Patel	8080501840	ENTC		
10	Adarsh Dipak Bhise		ENTC		
11	Vahagaonkar Kajal Vijay	9613771155	ENTC	<i>Vahagaonkar</i>	<i>Vahagaonkar</i>
12	Komal Sanjay Chavan		ENTC		
13	Mahamuni Kalyani Pradeep	7397887178	ENTC		
14	Priyanka Vasant Kasar		ENTC		
15	Varsha Vinod Kamble	7040040146	ENTC	<i>V Kamble</i>	<i>V Kamble</i>
16	Nikita Bhagvan Jadhav	8378894288	ENTC		
17	Shenolkar Vaishnavi Manoj		ENTC		
18	Dhanashri Mahadev Kadam	9359807948	ENTC	<i>D Kadam</i>	<i>D Kadam</i>
19	Sakshi Kuber Yadav	9067347823	ENTC		
20	Aditi Uddhav Jadhav	7666115372	ENTC	<i>AJadhav</i>	<i>AJadhav</i>
21	Komal Sanjay Chavan		ENTC		
22	Kamble Vinay Sunil		ENTC		
23	Shraddha Santosh Kate	9325720027	ENTC	<i>R Kate</i>	<i>R Kate</i>
24	Chavan Divya Raghunath		ENTC		
25	Shravani Hemant Shete	7219897004	ENTC	<i>H Shete</i>	<i>H Shete</i>
26	Snehal Kalyanrao Ningadale.	7387744886	ENTC	<i>S.K.Ningadale</i>	<i>SK Ningadale</i>
27	Saurabh Bhujangrao Patil	7741807080	ENTC	<i>S Patil</i>	<i>S Patil</i>
28	Ganesh Ankush Khabale		ENTC		
29	Aniket Anandrao Chavan	9503675335	ENTC		
30	Vaishnavi Raju Reke		ENTC		
31	Rutuja Vilas Autade	9527760542	ENTC	<i>R Autade</i>	<i>R Autade</i>
32	Misal Shivani Sanjay	7277551222	ENTC		
33	Bhagyawant Mrunali Maruti	7559472797	ENTC		
34	Jadhav Vishwajeet Murlidhar		ENTC		
35	Ganesh Ankush Khabale		ENTC		
36	Bhaldar Ajima Rafik	9175278551	ENTC		
37	Pawar Amruta Vikas	8284111324	ENTC		

→ P

Sr.No	Complete Name	Mob. No.	Branch	Sign.Session-I	Sign.Session-II
38	Todkar Reva Uday	7875269776	ENTC	<i>Rtodkar</i>	<i>Rtodkar</i>
39					
40					
41					
42					
43					
44					
45					
46					
47					
48					
49					
50					
51					
52					
53					
54					
55					
56					
57					
58					
59					
60					
61					
62					
63					
64					
65					
66					
67					
68					
69					
70					
71					
72					
73					
74					
75					
76					
77					
78					
79					
80					



Dr. Ashok Gujar Technical Institute's
Dr. Daulatrao Aher College of Engineering, Karad
Coding Training for TE - All Branches
Date : 10/08/2022 to 14/08/2022 Venue: Auditorium
Time: 9.30am to 5.30 pm Date:14/08/2022

Sr.No	Complete Name	Mob. No.	Branch	Sign.Session-I	Sign.Session-II
1	Shinde Rushikesh Suhas	9579779008	MECH		
2	Rasika Rajendra Tate		MECH		
3	Hrishikesh Gadve		MECH		
4	Sanket Dilip Deshmane	9370386170	MECH		
5	Pawar Vaishnavi Suryakant	9146991520	MECH	<i>Pawar</i>	
6	Prashant Nivas Pawar	9139523736	MECH		
7	Sonali Sunil Sonavale		MECH		
8	Shah Yash Prashant	9922523204	MECH		
9	Bagal Ganesh Suresh	7249764716	MECH		
10	Benzir Jakir Mulla	9284928597	MECH	<i>Mulla</i>	
11	Sahil Niyaj Mulla		MECH		
12	Muskan Abdul Mulani	8169689092	MECH	<i>Mulani</i>	<i>Mulani</i>
13	Shirwadkar Sahil Pravin.	9921753802	MECH		
14	Kurkute Digvijay Digambar	9673597469	MECH		
15	Wategaonkar Durvesh .S	8081946488	MECH		
16	Ramdasi Anuj .H	8380863533	MECH		
17	Dabhole Mahesh Rajendra	9730626656	MECH		
18	Yadav Prasad .P	9665546302	MECH		
19	Jamdar-Velhal Sarang .S	8459046850	MECH		
20	Desai Atharv .S	7083749174	MECH		
21	Waghmare Viki .S	9834331152	MECH		
22	Lavand Shambhuraj .D	8668210090	MECH		
23	Sathe Sanket Adhikrao	9168221205	MECH		
24	Sankpal Sunil Ravindra	9673012026	MECH		
25	Thombare Rohan Sukhdev	9372928387	MECH		
26	Shikalgar Rais javed	8766456890	MECH		
27	Kalburgi Shivam .B	8308660007	MECH		
28	Attar Azzharuddin .S	7972287600	MECH		
29	Dhumal Akash .A	9689948019	MECH		
30	Gujar Avdhut Jayant	9834476732	MECH		
31	Deshmukh Avinash .M	7030220302	MECH		
32	Desai Shubham Nivas	9765528126	MECH		
33	Dolare Rutik Kundalik	8888267891	MECH		
34	Bhusari Durgesh Sanjay	9370600401	MECH		
35	Jagtap Vishwajit .D	9834387577	MECH		
36	Khandelwal Piyush	9892750221	MECH		
37	Kharade Rohit	9325449132	MECH		

Sr.No	Complete Name	Mob. No.	Branch	Sign. Session-I	Sign. Session-II
38	Mayuri Vikas Yadav	7420841756	CSE	<i>Muyal</i>	<i>Muyal</i>
39	Vishwajeet Patil		CSE		
40	Rohit Adhikrao Dange	8485873277	CSE		
41	Mulla Daud Shabbir	7558706011	CSE	<i>D.S.mulla</i>	<i>D.S.mulla</i>
42	Salunkhe Siddhiraj Dadiram		CSE		
43	Vishwajeet V. Suryawanshi	9527184379	CSE	<i>Vishwajeet</i>	<i>Vishwajeet</i>
44	Rohini Prakash Kumbhar		CSE		
45	Vedanti Mukund Gore	9322468296	CSE	<i>Gore</i>	<i>Gore</i>
46	Anuja Rajendra Gaikwad	9172352097	CSE	<i>Anuja</i>	<i>Anuja</i>
47	Bhandare Siddesh Panjabrao		CSE		
48	Swaliha Haroon Mulla	9404849650	CSE		
49	Priti Vikas More	7028506092	CSE	<i>Pmore</i>	<i>Pmore</i>
50	Sohan Sutar	9767160938	CSE	<i>Sutar</i>	<i>Sutar</i>
51	Maithili Vasant Tirmare	9067373396	CSE	<i>MVT</i>	<i>MVT</i>
52	Shubhankar Suresh Nikam	9225831193	CSE	<i>Nikam</i>	<i>Nikam</i>
53	Snehal Ramesh Patil	9665723462	CSE	<i>Patil</i>	<i>Patil</i>
54	Rutuja Anil Koli		CSE		
55	Nikita Anil Yadav	7420991333	CSE		
56	Chavan Mayuri Vikas	8554935834	CSE	<i>Mayur</i>	<i>Mayur</i>
57	Nikhil Jaywant Ghare	7770030956	CSE		
58	Siddhant Dipak Harne	9604004773	CSE	<i>Harne</i>	<i>Harne</i>
59	Harshada Ashok Tapase	9595111395	CSE		
60	Sai Vijay Mane	9284088497	CSE		
61	Srushti Mahesh Davadate	9373366465	CSE		
62	Bhosale Prasad Sunil	9822545182	CSE		
63	Bhosale Saurabh .S	9657286931	CSE		
64	Pawar Omkar Shrinivas	7058076931	CSE		
65	Patil Ashwin Babasaheb	8412017271	CSE		
66	Yadav Vipul Vijay	9763492600	CSE		
67	Mansuriya Ami .D	9421603958	CSE	<i>Mansuriya</i>	<i>Mansuriya</i>
68	Patil Trupti Suryakant	8698823161	CSE	<i>Patil</i>	<i>Patil</i>
69	Sathe Shilaja .S	8010850378	CSE		
70	Yedage Dhanashri .H	7767910492	CSE		
71	Desai Mayuri Sanjay	9370572782	CSE		
72	Sankpal Trushna Sanjay	7821950235	CSE		
73	Mane Radhika Rajendra	7719894931	CSE		
74	Jadhav Payal Avinash	7249389506	CSE	<i>Payal</i>	<i>Payal</i>
75	Kokane Shraddha .S	8788396702	CSE		
76	Pawar Aishwarya .P	9021031086	CSE	<i>A.P.Pawar</i>	<i>A.P.Pawar</i>
77	Patil Dipti Suryakant	8698823160	CSE	<i>Patil</i>	<i>Patil</i>
78	Diksha Rajesh Adsule	9145297025	CSE	<i>Adsule</i>	<i>Adsule</i>
79	Keshavnagar Vaishnavi M.	8857089056	CSE	<i>Vaishnavi</i>	<i>Vaishnavi</i>
80					



Dr. Ashok Gujar Technical Institute's
Dr. Daulatrao Aher College of Engineering, Karad
Coding Training for TE - All Branches
Date : 10/08/2022 to 14/08/2022 Venue: Auditorium
Time: 9.30am to 5.30 pm Date:14/08/2022

Sr.No	Complete Name	Mob. No.	Branch	Sign.Session-I	Sign.Session-II
1	Suyash Ranjitsinh Ghatage		Civil		
2	Chavan Rushikesh Sunil		Civil		
3	Shreya Murlidhar Kamble		Civil		
4	Yadav Kiran Mahadeo	9892334331	Civil		
5	Waghmare Ankita Rajendra		Civil		
6	Priya Shivaji Ingavale		Civil		
7	Mulla Anisahmad Kabirhusen		Civil		
8	Rajput Shreya Yuvrajsing	8600962529	Civil		
9	Monika Mahesh Rathod		Civil		
10	Sagar Ashok Pawar		Civil		
11	Chunnade Shubhada Kedarnath		Civil		
12	Arati Bhiku Jadhav		Civil		
13	Pawar Nitish Rajendra		Civil		
14	Aniket Ananda Bansode		Civil		
15	Garud Priyanka Sanjay		Civil		
16	Ingavale Rupali Mahadev		Civil		
17	Nalawade Vrushali Suraj		Civil		
18	Rohit Sambhaji Mali		Civil		
19	Kumbhar Rohit Ashok		Civil		
20	Rutika Rajendra Pokale		Civil		
21	Omkar Rajendra Shinde		Civil		
22	Prerana Shivaji Hattigote		Civil		
23	Shagupta Isak Mutawalli		Civil		
24	Lade Sonal Ghanasham		Civil		
25	More Rahul Sitaram		Civil		
26	Patil Saurabh Subhash	98767972207	Civil	Patil	Patil
27					
28					
29					
30					
31					
32					
33					
34					
35					
36					
37					



Dr. Ashok Gujar Technical Institute's
Dr. Daulatrao Aher College of Engineering, Karad
Coding Training for TE - All Branches
Date : 10/08/2022 to 14/08/2022 Venue: Auditorium
Time: 9.30am to 5.30 pm Date:14/08/2022

Sr.No	Complete Name	Mob. No.	Branch	Sign.Session-I	Sign.Session-II
1	Rutuja Pandurang Lokare	8554043674	ENTC		
2	Priyanka Tanaji Pawar	9767363159	ENTC		
3	Ankita Rajaram Kamble	9119412171	ENTC		
4	Vaishnavi Dattatray Shivdas		ENTC		
5	Kajal Navnath Mohite	7666770359	ENTC		
6	Shraddha Dattatray Shinde	9665149606	ENTC		
7	Mulla Salina Sameer	9766404813	ENTC		
8	Chavan Pratiksha Ratnakar	9730327563	ENTC		
9	Ayesha Altaf Patel	8080501840	ENTC		
10	Adarsh Dipak Bhise		ENTC		
11	Vahagaonkar Kajal Vijay	9613771155	ENTC		
12	Komal Sanjay Chavan		ENTC		
13	Mahamuni Kalyani Pradeep	7397887178	ENTC		
14	Priyanka Vasant Kasar		ENTC		
15	Varsha Vinod Kamble	7040040146	ENTC		
16	Nikita Bhagvan Jadhav	8378894288	ENTC		
17	Shenolkar Vaishnavi Manoj		ENTC		
18	Dhanashri Mahadev Kadam	9359807948	ENTC		
19	Sakshi Kuber Yadav	9067347823	ENTC		
20	Aditi Uddhav Jadhav	7666115372	ENTC		
21	Komal Sanjay Chavan		ENTC		
22	Kamble Vinay Sunil		ENTC		
23	Shraddha Santosh Kate	9325720027	ENTC		
24	Chavan Divya Raghunath		ENTC		
25	Shravani Hemant Shete	7219897004	ENTC		
26	Snehal Kalyanrao Ningadale.	7387744886	ENTC	<i>Sk.Ningadale</i>	<i>S.k.Ningadale</i>
27	Saurabh Bhujangrao Patil	7741807080	ENTC		
28	Ganesh Ankush Khabale		ENTC		
29	Aniket Anandrao Chavan	9503675335	ENTC		
30	Vaishnavi Raju Reke		ENTC		
31	Rutuja Vilas Autade	9527760542	ENTC		
32	Misal Shivani Sanjay	7277551222	ENTC		
33	Bhagyawant Mrunali Maruti	7559472797	ENTC		
34	Jadhav Vishwajeet Murlidhar		ENTC		
35	Ganesh Ankush Khabale		ENTC		
36	Bhaldar Ajima Rafik	9175278551	ENTC		
37	Pawar Amruta Vikas	8284111324	ENTC		



Dr. Ashok Gujar Technical Institute's
Dr. Daulatrao Aher College of Engineering, Karad
Coding Training for TE - All Branches
Date : 10/08/2022 to 14/08/2022 Venue: Auditorium
Time: 9.30am to 5.30 pm Date:14/08/2022

Sr.No	Complete Name	Mob. No.	Branch	Sign. Session-I	Sign. Session-II
1	Manali Ravikant Jadhav	8208379145	CSE	<i>M Jadhav</i>	<i>M Jadhav</i>
2	Manali Vijay Potdar	7350382359	CSE	<i>M Potdar</i>	<i>M Potdar</i>
3	Vishwajit Dipak Suryawanshi	9579816391	CSE	<i>V Suryawanshi</i>	<i>V Suryawanshi</i>
4	Pratiksha Sanjay Patil	9022607510	CSE	<i>P Patil</i>	<i>P Patil</i>
5	Omkar Siddhanath Sawant	9561214133	CSE		
6	Muskan Tayyabali Mulla	9175658899	CSE	<i>M Mulla</i>	<i>M Mulla</i>
7	Kadam Kajal Chandrakant	9850130244	CSE		
8	Neha Nitin Pansande	7249739306	CSE		
9	Karan Abashaheb More	7038936357	CSE	<i>K More</i>	<i>K More</i>
10	Rutuja Anil Koli	7558676557	CSE	<i>R Koli</i>	<i>R Koli</i>
11	Shreya Sayaji Kadam	8767995423	CSE		
12	Gharge Pranali		CSE		
13	Shinde Rutuja Prashant		CSE		
14	Pragati Mahesh Patil	9834151913	CSE	<i>P Patil</i>	<i>P Patil</i>
15	Katre Pallavi Kundlik		CSE	<i>P Katre</i>	<i>P Katre</i>
16	Isha Sandip Bondre	7387790443	CSE		
17	Nikita Mukund Adake		CSE		
18	Ghutukade Swapnil Dada		CSE		
19	Kartiki Sanjay Wangade	9067460565	CSE	<i>K Wangade</i>	<i>K Wangade</i>
20	Rutuja Sanjay Kesare	7387913813	CSE	<i>R.S.Kesare</i>	<i>R.S.Kesare</i>
21	Gurav Bhagyashree Shashikant	8459991695	CSE		
22	Sawant Ekta Ravindra	8668332704	CSE		
23	Kumbhar Prajka Kamalakar	9307362504	CSE	<i>P Kumbhar</i>	<i>P Kumbhar</i>
24	Khandagale Dhanshri Chhagan	7249674690	CSE	<i>D Chhagan</i>	<i>D Chhagan</i>
25	Rohan Sanjay Kadam		CSE		
26	Mrunali Nanaso Shinde		CSE		
27	Namrata Mahadeo Shinde	7774927171	CSE		
28	Harshada Ashok Tapase	9595111395	CSE		
29	Shreya Sharad Jadhav	7620434340	CSE	<i>S Jadhav</i>	<i>S Jadhav</i>
30	Kumbhar Pooja Uday		CSE	<i>P Kumbhar</i>	<i>P Kumbhar</i>
31	Ajinkya Vijay Kumbhar		CSE		
32	Ajinkya Vijay Kumbhar		CSE		
33	Pranali Arun Suryawanshi	9552693272	CSE	<i>P Suryawanshi</i>	<i>P Suryawanshi</i>
34	Prathmesh Balaso Shelar	8657612390	CSE	<i>P Shelar</i>	<i>P Shelar</i>
35	Yadav Samiksha Ramesh	9504774747	CSE		
36	Uday Dnyandev Raje		CSE		
37	Aarya Atul Vaske	7588474474	CSE		

Sr.No	Complete Name	Mob. No.	Branch	Sign. Session-I	Sign. Session-II
38	Mayuri Vikas Yadav	7420841756	CSE		
39	Vishwajeet Patil		CSE		
40	Rohit Adhikrao Dange	8485873277	CSE		
41	Mulla Daud Shabbir	7558706011	CSE	D.S.Mulla	D.S.Mulla
42	Salunkhe Siddhiraj Dadiram		CSE		
43	Vishwajeet V. Suryawanshi	9527184379	CSE		
44	Rohini Prakash Kumbhar		CSE		
45	Vedanti Mukund Gore	9322468296	CSE		
46	Anuja Rajendra Gaikwad	9172352097	CSE		
47	Bhandare Siddesh Panjabrao		CSE		
48	Swaliha Haroon Mulla	9404849650	CSE		
49	Priti Vikas More	7028506092	CSE	P. More	P. More
50	Sohan Sutar	9767160938	CSE		
51	Maithili Vasant Tirmare	9067373396	CSE		
52	Shubhankar Suresh Nikam	9225831193	CSE	Nikam	Nikam
53	Snehal Ramesh Patil	9665723462	CSE	Patil	Patil
54	Rutuja Anil Koli		CSE		
55	Nikita Anil Yadav	7420991333	CSE		
56	Chavan Mayuri Vikas	8554935834	CSE		
57	Nikhil Jaywant Ghare	7770030956	CSE		
58	Siddhant Dipak Harne	9604004773	CSE		
59	Harshada Ashok Tapase	9595111395	CSE		
60	Sai Vijay Mane	9284088497	CSE		
61	Srushti Mahesh Davadate	9373366465	CSE		
62	Bhosale Prasad Sunil	9822545182	CSE		
63	Bhosale Saurabh .S	9657286931	CSE		
64	Pawar Omkar Shrinivas	7058076931	CSE		
65	Patil Ashwin Babasaheb	8412017271	CSE		
66	Yadav Vipul Vijay	9763492600	CSE		
67	Mansuriya Ami .D	9421603958	CSE	Ami	Ami
68	Patil Trupti Suryakant	8698823161	CSE	Patil	Patil
69	Sathe Shilaja .S	8010850378	CSE		
70	Yedage Dhanashri .H	7767910492	CSE		
71	Desai Mayuri Sanjay	9370572782	CSE	Desai	Desai
72	Sankpal Trushna Sanjay	7821950235	CSE		
73	Mane Radhika Rajendra	7719894931	CSE		
74	Jadhav Payal Avinash	7249389506	CSE		
75	Kokane Shraddha .S	8788396702	CSE		
76	Pawar Aishwarya .P	9021031086	CSE		
77	Diksha Rajesh Adsule	9145247025	CSE	Adsule	Adsule
78	Kshirsagar Varishnavi M	8857087056	CSE	Varishnavi	Varishnavi
79	Patil Dipti Suryakant	8698823160	CSE	Patil	Patil
80					



Mr. Rohit Patil



G. K. Gujar Memorial Charitable Trust's
Dr. Ashok Gujar Technical Institute's
Dr. Daulatrao Aher College of Engineering, Karad
Accredited by NAAC with B+ & ISO 9001-2008 Certified Institute
Training & Placement Cell

AGTIs / DACOE/TPO/2022-2023/

Date: 19/09/2022

Aptitude Training Notice

All the students of T. Y. B. Tech –CSE, ENTC, MECH, & CIVIL batch, are hereby informed to note that **Aptitude Training-** by Mr. Rohit Patil, Skillogic is scheduled for preparation for campus placement. This training is very much crucial for the student's campus placement. All the student should attend the training as per the following schedule. **The attendance is compulsory for all the students.**

Time: 9:30 am to 5:30 pm

Lunch Break: 1:00 pm to 2:00 pm

Overall Coordination: Ms. R. A. Katkar

Sr.No.	Date & Time	Class & Branch	Venue	Coordinators
1	23/09/2022	T.Y.- MECH & ENTC	CR- 18 Mech.Dept.	Mr. V. D. Yadav Ms. B. S. Kadam
2	24/09/2022	T.Y.- CIVIL & CSE	CR- 18 Mech.Dept.	Mr. S. P. Chavan Ms. A. R. Kadve
3	30/09/2022	T.Y.- MECH & ENTC	CR- 18 Mech.Dept.	Mr. V. D. Yadav Ms. B. S. Kadam
4	01/10/2022	T.Y.- CIVIL & CSE	CR- 18 Mech.Dept.	Mr. S. P. Chavan Ms. A. R. Kadve

Prof. H. M. Kumbhar
Vice- Principal

Dr. Anwar M. Mulla
Principal

Cc:

Dean- Academics	<i>F. T. Patil</i>	TPO	<i>B. M. Patil</i>
HOD - MECH	<i>M. S. Patil</i>	HOD - CSE	<i>R. Patil</i>
HOD - EXTC	<i>F. T. Patil</i>	HOD - CIVIL	<i>R. Patil</i>
TPC - MECH	<i>F. T. Patil</i>	TPC - CSE	<i>R. Patil</i>
TPC - EXTC	<i>F. T. Patil</i>	TPC - CIVIL	<i>R. Patil</i>

Date:



Dr. Ashok Gujar Technical Institute's
Dr. Daulatrao Aher College of Engineering, Karad
Aptitude Training for TY - All Branches
Date : 23/09/2022 Venue: CR- 19 Mech. Dept.
Time: 9.30am to 5.30 pm

Sr.No	Complete Name	Mob. No.	Branch	Sign.Session-I	Sign.Session-II	
1	Abhishek S Pawar	9579352524	MECH	Rawar	Rawar	
2	Balawant A Jadhav	8530115806	MECH			AB
3	Bobade Mahesh Sadashiv	9579060048	MECH	M&B	M&B	
4	Dingane Omkar Shivaji	8830444197	MECH	GD	GD	
5	Gavate Shreyas Mahesh		MECH			AB
6	Himanshu Devbhushan A	7588333162	MECH	Daphale	Daphale	
7	Jamale Tushar Nathuram	9370518250	MECH	Tushar	Tushar	
8	Lohar Vedant Bhaskar	8482979617	MECH			AB
9	More Pratik Satish	8010762605	MECH	More	More	
10	Patil Sangram Maruti	7219480483	MECH	Patil	Patil	
11	Prathamesh Mukund G	8421947633	MECH	Prathamesh	Prathamesh	
12	Ratan P Thorat	7219497793	MECH	Rathor	Rathor	
13	Sande Sajid Jahangir	9673402075	MECH	Sande	Sande	
14	Shubham Shivaji Thorat	7218575727	MECH			AB
15	Patil Saurabh Shankar		MECH			AB
16	Attar Namira Ayub		MECH			AB
17	Kamble Prajka Shantaram		MECH			AB
18	Jagtap Pragati Pratap		MECH			AB
19	Devgan Vaishnavi A	9881139280	MECH	Devgan	Devgan	
20	Patel Arshiya Tajuddin	9809265857	MECH	Patel	Patel	
21	Kaware Kalyani Balaso		MECH			AB
22	Gadave Rutuja Rajendra	9146494964	MECH	Gadave	Gadave	
23	Patil Sayali Tukaram		MECH			AB
24	Patel Aavej Vahid	9834204940	MECH	Patel	Patel	
25	Dhavade Tejas C	7040983522	MECH	Dhavade	Dhavade	
26	Patel Shoyab Altaf	7020067826	MECH	S.Patel	S.Patel	
27	Soheb Jabbar Bagwan	7559324810	MECH	S. J. Bagwan	S. J. Bagwan	
28	Lad Ruchika Rajendra		MECH			AB
29	Kadam Suhas Suresh		MECH			AB
30	Madane Omkar Mukund	9730329809	MECH			AB
31	Keluskar Atharav Rajendra	9384342168	MECH	Keluskar	Keluskar	
32	Kamble Aditya Dilip	9922069754	MECH	Kamble	Kamble	
33	Kumbhar Avishkar S	7057831609	MECH	Kumbhar	Kumbhar	
34	Jadhav Romesha Adhikrao		MECH			AB
35	Jadhav Jaydip Ganesh	7350205298	MECH			AB
36	Kutte Mayuresh M		MECH			AB
37	Patil Indrajeet Satish	8805308080	MECH	Patil	Patil	Partly

Sr.No	Complete Name	Mob. No.	Branch	Sign.Session-I	Sign.Session-II	
38	Kanade Kaustubh Avinash	8669109047	MECH	<i>Kanade</i>	<i>Kanade</i>	AB
39	Patil Shivraj Sandeep	7219550911	MECH	<i>Patil</i>	<i>Patil</i>	AB
40	Sabale Aryan Satyawan		MECH			AB
41	Pawar Ranjeet Satish		MECH			AB
42	Desai Shivam Ashok		MECH			AB
43	Shaikh Umar Samir		MECH			AB
44	Bhingardeve Rushikesh R		MECH			AB
45	Mahadik Aniruddha A		MECH			AB
46	Patil Ganesh Sambhaji	937020711	MECH	<i>Patil</i>	<i>Patil</i>	AB
47	Kokare Vishwajeet S	928488706	MECH	<i>Kokare</i>	<i>Kokare</i>	AB
48	Sonavane Prathamesh Biju		MECH			AB
49	Velhal Rutvik Sunil	9156992957	MECH	<i>Velhal</i>	<i>Velhal</i>	AB
50	Pol Shivam Rajendra	9158406519	MECH	<i>Pol</i>	<i>Pol</i>	AB
51	Sonavale Satyam Mohan		MECH			AB
52	Choudhari Akash A		MECH			AB
53	Nalawade Sagar Sunil		MECH			AB
54	Nalawade Akshay Dinkar		MECH			AB
55	Mane Manthan Vidhyanath		MECH			AB
56	Thakur Darshankumar S		MECH			AB
57	Shaikh Faizal Gaibesab		MECH			AB
58	Dhumal Rohit Mohan		MECH			AB
59	Jadhav Tejas Jaykar		MECH			AB
60	Dubal Dinesh Sudhakar		MECH			AB
61	Bandal Ajinkyadev Arun		MECH			AB
62	Sutar Bhalchandra Prakash		MECH			AB
63	Torane Abhishek Hanmant		MECH			AB
64	Mulik Vinayak Vijay		MECH			AB
65	Nikam Hrishikesh Kuldip	9284313261	MECH	<i>Nikam</i>	<i>Nikam</i>	AB
66	Matekar Amar Yashwant		MECH			AB
67	Shinde Omkar Vilas		MECH			AB
68	Gaikwad Santosh D		MECH			AB
69	Pawar Suraj Shivaji		MECH			AB
70	Sawant Sairaj Suresh		MECH			AB
71	Gurav Ajinkya Ramesh		MECH			AB
72						AB
73						
74						
75						
76						
77						
78						
79						
80						
81						

Presently
 * Morning 28
 * Afternoon 27



Dr. Ashok Gujar Technical Institute's
Dr. Daulatrao Aher College of Engineering, Karad
Aptitude Training for TY - All Branches
Date : 23/09/2022 Venue: CR- 19 Mech. Dept.
Time: 9.30am to 5.30 pm

Sr.No	Complete Name	Mob. No.	Branch	Sign.Session-I	Sign.Session-II
1	BhingardeveVidhya .G	776988254	ENTC	Bdeve	Bdeve
2	Dsouza Venissa Prakash	7058286016	ENTC	Dsouza	Dsouza
3	Jadhav Yashshree Prashant		ENTC		
4	Shetty Gautami Avinash	9623140669	ENTC	Shetty	Shetty
5	Patil Shruti Rajaram	9172370019	ENTC	Patil	Patil
6	Mane Vaishnavi Jeevan	7558683262	ENTC	Mane	Mane
7	Patil Rutuja Dilip	7020558900	ENTC	Patil	Patil
8	Patil Satyajit Ashok		ENTC		
9	Patil Shivraj Shashikant		ENTC		
10	Mane Prakash Jaysing		ENTC		
11	Kashid Sanket Maruti		ENTC		
12	Chavan Gayatri Laxman		ENTC		
13	Patel Afsana Rashid	9689435309	ENTC	Patel	Patel
14	Magdum Swapnali Vilas	7083796588	ENTC	Magdum	Magdum
15	Mane Shweta Sunil	9325285444	ENTC	Mane	Mane
16	Lade Anamika Dipak		ENTC		
17	Patil Aditi Rajendra		ENTC		
18	Pawar Pranita Appaso		ENTC		
19	Shinde Vaishnavi B		ENTC		
20	Lole Rutika Sambhaji	8181920302	ENTC	Lole	Lole
21	Patil Gauri Tanaji	9579551057	ENTC	Patil	Patil
22	Jadhav Aishwarya Abaso		ENTC		
23	Thapa Durva Chandrakant	9322657390	ENTC	Thapa	Thapa
24	Salave Dipti Bhimarao	9356564212	ENTC	Salave	Salave
25	Lade Tanvi Sandesh	7088130510	ENTC	Lade	Lade
26	Shinde Vaishnavi Vikas	7821970159	ENTC	Shinde	Shinde
27	Kashilkar Shreya Dhananjay	9145666851	ENTC	Kashilkar	Kashilkar
28	Todkar Shradha Jitendra		ENTC		
29	Chavan Shivani Sayaji		ENTC		
30	Pawar Gayatri Suhas		ENTC		
31	Jadhav Sakshi Dattaji	9167182008	ENTC	Jadhav	Jadhav
32	Nikam Pranav Subhash	7620511847	ENTC	Nikam	
33	Phalle Bhagavant Anil	9970698840	ENTC	Phalle	
34	Pawar Ganesh Mohan		ENTC		
35	Kachare Harshavardhan J.	9923501425	ENTC	Kachare	
36	Kanase Aditya Ashok	9309210798	ENTC	Kanase	Kanase
37	Mulla Muskan Iqbal		ENTC		
38	Sayyad Siddiq Nijam		ENTC		

Sr.No	Complete Name	Mob. No.	Branch	Sign.Session-I	Sign.Session-II
39	Ghutugade Sanket Sambhaji	9016113038	ENTC	Sanket	
40	Nalawade Rushikesh .R		ENTC		
41	Gharage Shivam Sanjay		ENTC		
42	Desai Prathamesh Dattatray		ENTC		
43	Chavan Swapnali Mahadev		ENTC		
44	Kazi Ayan Nasir		ENTC		
45	Gurav Dattatray Dnyendev		ENTC		
46					
47					
48					
49					
50					
51					
52					
53					
54					
55					
56					
57					
58					
59					
60					
61					
62					
63					
64					
65					
66					
67					
68					
69					
70					
71					
72					
73					
74					
75					
76					
77					
78					
79					
80					
81					
82					
83					



Dr. Ashok Gujar Technical Institute's
Dr. Daulatrao Aher College of Engineering, Karad
Aptitude Training for TY - All Branches
Date : 24/09/2022 Venue: CR- 19 Mech. Dept.
Time: 9.30am to 5.30 pm

Sr.No	Complete Name	Mob. No.	Branch	Sign.Session-I	Sign.Session-II
1	Attar Ajnan Dastagir		CIVIL		
2	Babar Akshay Jaysing		CIVIL		
3	Baing Aniket Shankar		CIVIL		
4	Bamane Sanket Bhaskar		CIVIL		
5	Bhagwat Akash Jaywant		CIVIL		
6	Bhandwalkar Omkar Mahadev	8605661217	CIVIL	Bhandwalkar	Bhandwalkar
7	Bhasme Aishwarya. C		CIVIL		
8	Bhat Samruddhi Sagar		CIVIL		
9	Bhoi Rohit Anil		CIVIL		
10	Bhopate Nilesh Mohan		CIVIL		
11	Chalke Abhishek Eknath		CIVIL		
12	Channe Shubham Shankar		CIVIL		
13	Chavan Abhijit Suresh		CIVIL		
14	Chavan Omkar Shivaji		CIVIL		
15	Chavan Rutuja Sambhajirao	8552009201	CIVIL	Rutuja	Rutuja
16	Chavan Sunil Rajaram	8806877166	CIVIL	Sunil C.	Sunil C.
17	Desai Suraj Shivaji		CIVIL		
18	Deshmukh Saurabh Rajendra		CIVIL		
19	Devlekar Nitraj Nitin		CIVIL		
20	Dhulugade Pratik Shankar		CIVIL		
21	Dingane Prachi Rajendra	8888064925	CIVIL	Dingane	Dingane
22	Falke Akanksha Ashok	9511762701	CIVIL	Akash	Akash
23	Ghadage Prithviraj Sarjerao	9350292091	CIVIL	Ghadage	Ghadage
24	Gharge Sameer Rajendra		CIVIL		
25	Jadhav Bhagyashree Ravindra		CIVIL		
26	Jadhav Dhiraj Shahaji	7820976798	CIVIL	Jadhav	Jadhav
27	Jadhav Pranit Sunil		CIVIL		
28	Jadhav Shraddha Mahesh	8482802402	CIVIL	Shraddha	Shraddha
29	Jadhav Uday Arun		CIVIL		
30	Jadhav Vishwajeet Shashikant	9359278879	CIVIL	Vishwajeet	Vishwajeet
31	Jagdale Shivendra Rajendra		CIVIL		
32	Jagtap Gaurav Dhananjay		CIVIL		
33	Janrao Sandhya Kishor	9145665872	CIVIL	Janrao	Janrao
34	Janugade Pranav Anandrao	9145787662	CIVIL	Pranav	Pranav
35	Jujar Tejaswi Suresh	8010503075	CIVIL	Jujar	Jujar
36	Kachare Avadhut Kamalakar	9545835741	CIVIL	Kachare	Kachare
37	Kachhi Aman Ayub	7887784666	CIVIL	Aman	Aman
38	Kadam Aditya Sushilkumar		CIVIL		



Dr. Ashok Gujar Technical Institute's
Dr. Daulatrao Aher College of Engineering, Karad
Aptitude Training for TY - All Branches
Date : 24/09/2022 Venue: CR- 19 Mech. Dept.
Time: 9.30am to 5.30 pm

Sr.No	Complete Name	Mob. No.	Branch	Sign. Session-I	Sign. Session-II
1	Acharya Prathmesh Prasad		CSE		
2	Bagwan Kamil M Rafique		CSE		
3	Bansode Vidya Pravin		CSE		
4	Chavan Prashant Yuvraj	7410598085	CSE	<i>Prashant</i>	<i>Prashant</i>
5	Chavan Shubham Sanjay		CSE		
6	Chorage Ankita Chandrakant	7499201441	CSE	<i>Ankita</i>	<i>Ankita</i>
7	Chorage Pratik Arjun	8010719163	CSE	<i>Pratik</i>	<i>Pratik</i>
8	Christiyan Shine Jayan	7219649304	CSE	<i>Shine</i>	<i>Shine</i>
9	Couto Glenn Gilbert		CSE		
10	Chavan Tejaswini Dilip	8010819671	CSE	<i>Tejaswini</i>	<i>Tejaswini</i>
11	Desai Rohan Ramesh		CSE		
12	Gadale Snehal Krishna	7757209415	CSE	<i>Snehal</i>	<i>Snehal</i>
13	Gawade Komal Kiran		CSE		
14	Gurav Aishwarya Rajendra	9922513571	CSE	<i>Aishwarya</i>	
15	Inamdar Diya Ramjan	7709102458	CSE	<i>Diya</i>	<i>Diya</i>
16	Inamdar Zaid Salim	832963425	CSE	<i>Zaid</i>	<i>Zaid</i>
17	Jadhav Snehal Sanjay	7264038042	CSE	<i>Snehal</i>	<i>Snehal</i>
18	Kadam Sakshi Milind	7020541437	CSE	<i>Sakshi</i>	<i>Sakshi</i>
19	Kalaskar Abhishek Pandit	985007898	CSE	<i>Abhishek</i>	<i>Abhishek</i>
20	Kamble Pooja Babasaheb	9325091466	CSE	<i>Pooja</i>	<i>Pooja</i>
21	Karale Aakanksha C	9075105104	CSE	<i>Aakanksha</i>	<i>Aakanksha</i>
22	Karande Neha Ganesh	7757882932	CSE	<i>Neha</i>	<i>Neha</i>
23	Kate Asmita Yuvraj	8552658004	CSE	<i>Asmita</i>	<i>Asmita</i>
24	Katu Omkar Baban	9763953178	CSE	<i>Omkar</i>	<i>Omkar</i>
25	Kharat Minal Sudam	9322952846	CSE	<i>Minal</i>	
26	Khot Shruti Sharad		CSE		
27	Kodulkar Omkar Arun	757752204	CSE	<i>Omkar</i>	<i>Omkar</i>
28	Kumbhar Prathmesh Popat	9561841929	CSE	<i>Prathmesh</i>	<i>Prathmesh</i>
29	Lawand Manasi Mahesh	7058586838	CSE	<i>Manasi</i>	<i>Manasi</i>
30	Lohar Prajakta Prakash	7020421530	CSE	<i>Prajakta</i>	<i>Prajakta</i>
31	Mahadik Viraj Nitin	8915779161	CSE	<i>Viraj</i>	<i>Viraj</i>
32	Mahajan Mukti Premchand	9373946505	CSE	<i>Mukti</i>	<i>Mukti</i>
33	Mane Sanket Shinabhau		CSE		
34	Mohite Gaurav Ramdas	9021359203	CSE	<i>Gaurav</i>	<i>Gaurav</i>
35	Moolya Nidhish Narayan	9370217137	CSE	<i>Nidhish</i>	<i>Nidhish</i>
36	Mujawar Rizwan Abid	9975919156	CSE	<i>Rizwan</i>	<i>Rizwan</i>
37	Mujawar Saad Najir	7391942607	CSE	<i>Saad</i>	<i>Saad</i>
38	Mujawar Sayama Dilawar	7720044636	CSE	<i>Sayama</i>	<i>Sayama</i>

Sr.No	Complete Name	Mob. No.	Branch	Sign. Session-I	Sign. Session-II
39	Mulla Suhan Jameer	9975488562	CSE	Mulla	Mulla
40	Nagmal Prathamesh Yuvraj		CSE		
41	Nalawade Rutuja Jagannath	8010139065	CSE	Nalawade	
42	Nalawade Sanika Anil	9322766875	CSE	Nalawade	Nalawade
43	Pakhale Omkar Santosh	8530524197	CSE	Pakhale	Pakhale
44	Patil Mrunali Ashok		CSE		
45	Patil Pranjali Sanjay	9423453023	CSE	Patil	Patil
46	Patil Saylee Sanjay	9766652699	CSE	Patil	Patil
47	Patil Vaishnavi Ashok	87498409271	CSE	Patil	Patil
48	Patil Mrunal Mahesh	5373501755	CSE	Patil	Patil
49	Patil Pranjali Pradip	8485037156	CSE	Patil	Patil
50	Patil Sakshi Mohan	917239606	CSE	Patil	Patil
51	Patil Shreya Dadaso	9021102310	CSE	Patil	Patil
52	Patil Suyash Jivan	7066813773	CSE	Patil	Patil
53	Patil Vishal Ramkrishna		CSE		
54	Patole Shravani Mahesh		CSE		
55	Pawar Mayur Pratap	9359298530	CSE	Pawar	Pawar
56	Pawar Dhanashri Nitin	902249491	CSE	Pawar	Pawar
57	Pawar Harshali Madan		CSE		
58	Pawar Pratik Shankar	7219415049	CSE	Pawar	Pawar
59	Poojary Varsha Vasantha	9588650699	CSE	Poojary	Poojary
60	Pawar Kajal Krishnat	7666005251	CSE	Pawar	Pawar
61	Reke Parth Pradeep		CSE		
62	Salunkhe Rucha Sandesh	8010821614	CSE	Salunkhe	Salunkhe
63	Sarang Trupti Balaji		CSE		
64	Shedage Gauri Dhanaji	9550987006	CSE	Shedage	Shedage
65	Shejwal Archana Raju	8485854454	CSE	Shejwal	Shejwal
66	Shete Sakshi Dhananjay	8956452057	CSE	Shete	Shete
67	Shikalgar Juned Kamruddin		CSE		
68	Shinde Sanika Sandeep	9860851711	CSE	Shinde	Shinde
69	Shinde Sanika Sanjay	9356107975	CSE	Shinde	Shinde
70	Shinde Tanmay Balkrishna		CSE		
71	Shirsat Salonee Pravin	9834710741	CSE	Shirsat	Shirsat
72	Sonawale Sakshi Baburao	7391915503	CSE	Sonawale	Sonawale
73	Shaikh Alfiya Asif	7385205397	CSE	Shaikh	Shaikh
74	Tandale Pradnya Mahesh		CSE		
75	Vetal Shivanjali Ramrao	8010118088	CSE	Vetal	Vetal
76	Yadav Pratiksha Balasaheb	7028720289	CSE	Yadav	Yadav



Dr. Ashok Gujar Technical Institute's
Dr. Daulatrao Aher College of Engineering, Karad
Aptitude Training for TY - All Branches
Date : 01/10/2022 Venue: Auditorium
Time: 9.30am to 5.30 pm

Sr.No	Complete Name	Mob. No.	Branch	Sign.Session-I	Sign.Session-II
1	Abhishek S Pawar	9579352526	MECH	Pawar	Pawar
2	Balawant A Jadhav	8530115806	MECH	Jadhav	AB
3	Bobade Mahesh Sadashiv		MECH	AB	AB
4	Dingane Omkar Shivaji	8830444197	MECH	AB	AB
5	Gavate Shreyas Mahesh		MECH	AB	AB
6	Himanshu Devbhushan A	7588333162	MECH	Baphale	Baphale
7	Jamale Tushar Nathuram	9370518219	MECH	Jamale	Jamale
8	Lohar Vedant Bhaskar		MECH	AB	AB
9	More Pratik Satish	8010762005	MECH	More	More
10	Patil Sangram Maruti	7219480483	MECH	Patil	Patil
11	Prathamesh Mukund G		MECH	AB	AB
12	Ratan P Thorat		MECH	AB	AB
13	Sande Sajid Jahangir		MECH	AB	AB
14	Shubham Shivaji Thorat		MECH	AB	AB
15	Patil Saurabh Shankar		MECH	AB	AB
16	Attar Namira Ayub		MECH	AB	AB
17	Kamble Prajкта Shantaram		MECH	AB	AB
18	Jagtap Pragati Pratap		MECH	AB	AB
19	Devgan Vaishnavi A	9881139280	MECH	Devgan	Devgan
20	Patel Arshiya Tajuddin	9209265857	MECH	Patel	Patel
21	Kaware Kalyani Balaso	8010425096	MECH	AB	AB
22	Gadave Rutuja Rajendra	9146494964	MECH	Gadave	Gadave
23	Patil Sayali Tukaram		MECH	AB	AB
24	Patel Aavej Vahid	9834204944	MECH	Patel	Patel
25	Dhavade Tejas C	7060983507	MECH	Dhavade	Dhavade
26	Patel Shoyab Altaf	7020067826	MECH	S.Patel	S.Patel
27	Soheb Jabbar Bagwan	7559324210	MECH	S. J. Bagwan	S. J. Bagwan
28	Lad Ruchika Rajendra	9359778793	MECH	Lad	Lad
29	Kadam Suhas Suresh		MECH	AB	AB
30	Madane Omkar Mukund	9730329809	MECH	Madane	Madane
31	Keluskar Atharav Rajendra		MECH	AB	AB
32	Kamble Aditya Dilip		MECH	AB	AB
33	Kumbhar Avishkar S	7057831609	MECH	ASK	ASK
34	Jadhav Romesha Adhikrao		MECH	AB	AB
35	Jadhav Jaydip Ganesh		MECH	AB	AB
36	Kutte Mayuresh M		MECH	AB	AB
37	Patil Indrajeet Satish		MECH	AB	AB
38	Kanade Kaustubh Avinash		MECH	AB	AB
39	Patil Shivraj Sandeep		MECH	AB	AB

Partly

AB

AB

Sr.No	Complete Name	Mob. No.	Branch	Sign.Session-I	Sign.Session-II
40	Sabale Aryan Satyawar		MECH	AB	AB
41	Pawar Ranjeet Satish		MECH	AB	AB
42	Desai Shivam Ashok	8432196353	MECH	AB	AB
43	Shaikh Umar Samir		MECH	AB	AB
44	Bhingardeve Rushikesh R		MECH	AB	AB
45	Mahadik Aniruddha A		MECH	AB	AB
46	Patil Ganesh Sambhaji		MECH	AB	AB
47	Kokare Vishwajeet S		MECH	AB	AB
48	Sonavane Prathamesh Biju		MECH	AB	AB
49	Velhal Rutvik Sunil	9156992957	MECH	RGretel	RGretel
50	Pol Shivam Rajendra		MECH	AB	AB
51	Sonavale Satyam Mohan		MECH	AB	AB
52	Choudhari Akash A		MECH	AB	AB
53	Nalawade Sagar Sunil		MECH	AB	AB
54	Nalawade Akshay Dinkar		MECH	AB	AB
55	Mane Manthan Vidhyanath		MECH	AB	AB
56	Thakur Darshankumar S		MECH	AB	AB
57	Shaikh Faizal Gaibesab		MECH	AB	AB
58	Dhumal Rohit Mohan		MECH	AB	AB
59	Jadhav Tejas Jaykar		MECH	AB	AB
60	Dubal Dinesh Sudhakar		MECH	AB	AB
61	Bandal Ajinkyadev Arun		MECH	AB	AB
62	Sutar Bhalchandra Prakash		MECH	AB	AB
63	Torane Abhishek Hanmant		MECH	AB	AB
64	Mulik Vinayak Vijay		MECH	AB	AB
65	Nikam Hrishikesh Kuldip	9286313261	MECH	Kilka	Kilka
66	Matekar Amar Yashwant		MECH	AB	AB
67	Shinde Omkar Vilas		MECH	AB	AB
68	Gaikwad Santosh D		MECH	AB	AB
69	Pawar Suraj Shivaji		MECH	AB	AB
70	Sawant Sairaj Suresh		MECH	AB	AB
71	Gurav Ajinkya Ramesh		MECH	AB	AB
72					
73					
74					
75					
76					
77					
78					
79					
80					
81					
82					
83					
84					
85					

Session I : $16+4 = \underline{20}$

Session II : $\underline{20}$



Dr. Ashok Gujar Technical Institute's
Dr. Daulatrao Aher College of Engineering, Karad
Aptitude Training for TY - All Branches
Date : 01/10/2022 Venue: Auditorium
Time: 9.30am to 5.30 pm

Sr.No	Complete Name	Mob. No.	Branch	Sign.Session-I	Sign.Session-II
1	BhingardeveVidhya .G	7769882534	ENTC	<i>B. Deve</i>	<i>B. Deve</i>
2	Dsouza Venissa Prakash	7058286016	ENTC	<i>D. S. Prakash</i>	<i>D. S. Prakash</i>
3	Jadhav Yashshree Prashant		ENTC		
4	Shetty Gautami Avinash	9623140669	ENTC	<i>G. Shetty</i>	<i>G. Shetty</i>
5	Patil Shruti Rajaram	9172370019	ENTC	<i>S. Patil</i>	<i>S. Patil</i>
6	Mane Vaishnavi Jeevan	7558663262	ENTC	<i>M. Mane</i>	<i>M. Mane</i>
7	Patil Rutuja Dilip	7020558900	ENTC	<i>R. Patil</i>	<i>R. Patil</i>
8	Patil Satyajit Ashok		ENTC		
9	Patil Shivraj Shashikant		ENTC		
10	Mane Prakash Jaysing		ENTC		
11	Kashid Sanket Maruti		ENTC		
12	Chavan Gayatri Laxman		ENTC		
13	Patel Afsana Rashid	9689235301	ENTC	<i>A. Patel</i>	<i>A. Patel</i>
14	Magdum Swapnali Vilas	7083796588	ENTC	<i>M. Swapnali</i>	<i>M. Swapnali</i>
15	Mane Shweta Sunil	9325285441	ENTC	<i>S. Mane</i>	<i>S. Mane</i>
16	Lade Anamika Dipak		ENTC		
17	Patil Aditi Rajendra		ENTC		
18	Pawar Pranita Appaso		ENTC		
19	Shinde Vaishnavi B		ENTC		
20	Lole Rutika Sambhaji		ENTC		
21	Patil Gauri Tanaji	9579551051	ENTC	<i>G. Patil</i>	<i>G. Patil</i>
22	Jadhav Aishwarya Abaso	9561489377	ENTC	<i>A. Jadhav</i>	<i>A. Jadhav</i>
23	Thapa Durva Chandrakant	9322657390	ENTC	<i>D. Thapa</i>	<i>D. Thapa</i>
24	Salave Dipti Bhimarao	9356569212	ENTC	<i>D. Salave</i>	<i>D. Salave</i>
25	Lade Tanvi Sandesh	7038130510	ENTC	<i>T. Lade</i>	<i>T. Lade</i>
26	Shinde Vaishnavi Vikas	792570159	ENTC	<i>V. Shinde</i>	<i>V. Shinde</i>
27	Kashilkar Shreya Dhananjay		ENTC		
28	Todkar Shradha Jitendra		ENTC		
29	Chavan Shivani Sayaji		ENTC		
30	Pawar Gayatri Suhas		ENTC		
31	Jadhav Sakshi Dattaji		ENTC		
32	Nikam Pranav Subhash		ENTC		
33	Phalle Bhagavant Anil		ENTC		
34	Pawar Ganesh Mohan		ENTC		
35	Kachare Harshavardhan J.		ENTC		
36	Kanase Aditya Ashok	9309210798	ENTC	<i>A. Kanase</i>	<i>A. Kanase</i>
37	Mulla Muskan Iqbal		ENTC		
38	Sayyad Siddiq Nijam		ENTC		
39	Ghutugade Sanket Sambhaji	9016113038	ENTC	<i>S. Ghutugade</i>	<i>S. Ghutugade</i>
40	Nalawade Rushikesh .R		ENTC		

Sr.No	Complete Name	Mob. No.	Branch	Sign.Session-I	Sign.Session-II
41	Gharage Shivam Sanjay	9822303587	ENTC	<i>Gharage</i>	<i>Gharage</i>
42	Desai Prathamesh Dattatray		ENTC		
43	Chavan Swapnali Mahadev		ENTC		
44	Kazi Ayan Nasir		ENTC		
45	Gurav Dattatray Dnyendev		ENTC		
46					
47					
48					
49					
50					
51					
52					
53					
54					
55					
56					
57					
58					
59					
60					
61					
62					
63					
64					
65					
66					
67					
68					
69					
70					
71					
72					
73					
74					
75					
76					
77					
78					
79					
80					
81					
82					
83					



Dr. Ashok Gujar Technical Institute's
Dr. Daulatrao Aher College of Engineering, Karad
Aptitude Training for TY - All Branches
Date : 01/10/2022 Venue: Auditorium
Time: 9.30am to 5.30 pm

Sr.No	Complete Name	Mob. No.	Branch	Sign. Session-I	Sign. Session-II
1	Acharya Prathmesh Prasad		CSE		
2	Bagwan Kamil M Rafique	8482915280	CSE	Kailas	Kailas
3	Bansode Vidya Pravin	8010491990	CSE	Bansode	Bansode
4	Chavan Prashant Yuvraj	7410598085	CSE	Prashant	Prashant
5	Chavan Shubham Sanjay	9107171117	CSE	Shubham	Shubham
6	Chorage Ankita Chandrakant	7499201441	CSE	Chorage	
7	Chorage Pratik Arjun	8010719103	CSE	Chorage	Chorage
8	Christiyan Shine Jayan		CSE		
9	Couto Glenn Gilbert		CSE		
10	Chavan Tejaswini Dilip	8010814671	CSE	Chavan	Chavan
11	Desai Rohan Ramesh		CSE		
12	Gadale Snehal Krishna	7757809415	CSE	Gadale	Gadale
13	Gawade Komal Kiran	7304122863	CSE	Komal	Komal
14	Gurav Aishwarya Rajendra	9922513571	CSE	Aishwarya	
15	Inamdar Diya Ramjan	7709102458	CSE	Inamdar	Inamdar
16	Inamdar Zaid Salim	832963425	CSE	Zaid	Zaid
17	Jadhav Snehal Sanjay	7266038042	CSE	Jadhav	Jadhav
18	Kadam Sakshi Milind		CSE		
19	Kalaskar Abhishek Pandit	9850078968	CSE	Kalaskar	Kalaskar
20	Kamble Pooja Babasaheb	9325091466	CSE	Pooja	Pooja
21	Karale Aakanksha C	9075105104	CSE	Aakanksha	Aakanksha
22	Karande Neha Ganesh	7757882932	CSE	Neha	Neha
23	Kate Asmita Yuvraj	9552058004	CSE	Asmita	Asmita
24	Katu Omkar Baban		CSE		
25	Kharat Minal Sudam		CSE		
26	Khot Shruti Sharad		CSE		
27	Kodulkar Omkar Arun	9519752204	CSE	Omkar	Omkar
28	Kumbhar Prathmesh Popat	9561841929	CSE	Prathmesh	Prathmesh
29	Lawand Manasi Mahesh	7058586839	CSE	Manasi	Manasi
30	Lohar Prajakta Prakash	7020421530	CSE	Prajakta	Prajakta
31	Mahadik Viraj Nitin	8975779161	CSE	Viraj	Viraj
32	Mahajan Mukti Premchand	9373946508	CSE	Mukti	Mukti
33	Mane Sanket Shinabhau	9359006510	CSE	Mane	Mane
34	Mohite Gaurav Ramdas	9021359203	CSE	Gaurav	Gaurav
35	Moolya Nidhish Narayan	9370217137	CSE	Nidhish	Nidhish
36	Mujawar Rizwan Abid	9975919156	CSE	Rizwan	Rizwan
37	Mujawar Saad Najir	7391942667	CSE	Saad	Saad
38	Mujawar Sayama Dilawar	7720044636	CSE	Sayama	Sayama
39	Mulla Suhan Jameer	9975488962	CSE	Mulla	Mulla
40	Nagmal Prathamesh Yuvraj		CSE		

Sr.No	Complete Name	Mob. No.	Branch	Sign. Session-I	Sign. Session-II
41	Nalawade Rutuja Jagannath		CSE		
42	Nalawade Sanika Anil	9322766875	CSE	NSA	NSA
43	Pakhale Omkar Santosh	8530524197	CSE	OMKAR	OMKAR
44	Patil Mrunali Ashok		CSE		
45	Patil Pranjali Sanjay	9423453023	CSE	Pranjali	Pranjali
46	Patil Saylee Sanjay		CSE		
47	Patil Vaishnavi Ashok	7498409271	CSE	Vaish.	Vaish.
48	Patil Mrunal Mahesh		CSE		
49	Patil Pranjali Pradip	8585037156	CSE	Pranjali	Pranjali
50	Patil Sakshi Mohan	9172396016	CSE	Sakshi	Sakshi
51	Patil Shreya Dadaso	9021102310	CSE	Shreya	Shreya
52	Patil Suyash Jivan	7066813973	CSE	Suyash	Suyash
53	Patil Vishal Ramkrishna	9730220101	CSE	Vishal	Vishal
54	Patole Shravani Mahesh		CSE		
55	Pawar Mayur Pratap	9359298530	CSE	MPawar	MPawar
56	Pawar Dhanashri Nitin	9022449491	CSE	Dhanashri	Dhanashri
57	Pawar Harshali Madan		CSE		
58	Pawar Pratik Shankar	7219415049	CSE	Pratik	Pratik
59	Poojary Varsha Vasantha	9588650699	CSE	Varsha	Varsha
60	Pawar Kajal Krishnat		CSE		
61	Reke Parth Pradeep		CSE		
62	Salunkhe Rucha Sandesh	8010921614	CSE	Rucha	Rucha
63	Sarang Trupti Balaji	8855827719	CSE	Trupti	Trupti
64	Shedage Gauri Dhanaji	8550987006	CSE	Gauri	Gauri
65	Shejwal Archana Raju	8495856554	CSE	Archana	Archana
66	Shete Sakshi Dhananjay	8968752097	CSE	Sakshi	Sakshi
67	Shikalgar Juned Kamruddin	8169007031	CSE	Juned	Juned
68	Shinde Sanika Sandeep	9860851711	CSE	Sanika	Sanika
69	Shinde Sanika Sanjay	9356107975	CSE	Sanika	Sanika
70	Shinde Tanmay Balkrishna		CSE		
71	Shirsat Salonee Pravin		CSE		
72	Sonawale Sakshi Baburao	7391915503	CSE	Sonawale	Sonawale
73	Shaikh Alfiya Asif		CSE		
74	Tandale Pradnya Mahesh	966694399	CSE	Tandale	Tandale
75	Vetal Shivanjali Ramrao	8010118088	CSE	Vetal	Vetal
76	Yadav Pratiksha Balasaheb	9028772089	CSE	Yadav	Yadav



Dr. Ashok Gujar Technical Institute's
Dr. Daulatrao Aher College of Engineering, Karad
Aptitude Training for TY - All Branches
Date : 01/10/2022 Venue: Auditorium
Time: 9.30am to 5.30 pm

Sr.No	Complete Name	Mob. No.	Branch	Sign.Session-I	Sign.Session-II
1	Attar Ajnan Dastagir		CIVIL		
2	Babar Akshay Jaysing		CIVIL		
3	Baing Aniket Shankar		CIVIL		
4	Bamane Sanket Bhaskar	9370 89 00213	CIVIL	Bamane	
5	Bhagwat Akash Jaywant	91 36050503	CIVIL	Bhagwat	Bhagwat
6	Bhandwalkar Omkar Mahadev	8605661217	CIVIL	Bhandwalkar	Bhandwalkar
7	Bhasme Aishwarya. C	9284188895	CIVIL	Bhasme	Bhasme
8	Bhat Samruddhi Sagar	826385365	CIVIL	Bhat	Bhat
9	Bhoi Rohit Anil		CIVIL		
10	Bhopate Nilesh Mohan		CIVIL		
11	Chalke Abhishek Eknath		CIVIL		
12	Channe Shubham Shankar		CIVIL		
13	Chavan Abhijit Suresh		CIVIL		
14	Chavan Omkar Shivaji		CIVIL		
15	Chavan Rutuja Sambhajirao	8585253012	CIVIL	Chavan	Chavan
16	Chavan Sunil Rajaram	92 23247612	CIVIL	Chavan	
17	Desai Suraj Shivaji		CIVIL		
18	Deshmukh Saurabh Rajendra	8767474263	CIVIL	Deshmukh	Deshmukh
19	Devlekar Nitraj Nitin		CIVIL		
20	Dhulugade Pratik Shankar		CIVIL		
21	Dingane Prachi Rajendra	8888064325	CIVIL	Dingane	Dingane
22	Falke Akanksha Ashok	7499134848	CIVIL	Falke	
23	Ghadage Prithviraj Sarjerao		CIVIL		
24	Gharge Sameer Rajendra	7774062626	CIVIL	Gharge	Gharge
25	Jadhav Bhagyashree Ravindra		CIVIL		
26	Jadhav Dhiraj Shahaji	7620916799	CIVIL	Jadhav	Jadhav
27	Jadhav Pranit Sunil		CIVIL		
28	Jadhav Shraddha Mahesh	8482802402	CIVIL	Jadhav	Jadhav
29	Jadhav Uday Arun		CIVIL		
30	Jadhav Vishwajeet Shashikant	8698230195	CIVIL	Jadhav	
31	Jagdale Shivendra Rajendra		CIVIL		
32	Jagtap Gaurav Dhananjay		CIVIL		
33	Janrao Sandhya Kishor	9145605872	CIVIL	Janrao	Janrao
34	Janugade Pranav Anandrao	9145787662	CIVIL	Janugade	Janugade
35	Jujar Tejaswi Suresh	8010503075	CIVIL	Jujar	Jujar
36	Kachare Avadhut Kamalakar	9525835741	CIVIL	Kachare	Kachare
37	Kachhi Aman Ayub	7887784660	CIVIL	Kachhi	Kachhi
38	Kadam Aditya Sushilkumar	9960201952	CIVIL	Kadam	Kadam
39	Kadam Akshay Jagannth		CIVIL		
40	Kadam Anuja Chandrakant	8080357319	CIVIL	Kadam	Kadam



Mr. Rohit Patil



Shot on Y15
Vivo AI camera

2020.03.05 11:42



12
(8)

G. K. Gujar Memorial Charitable Trust's
Dr. Ashok Gujar Technical Institute's
Dr. Daulatrao Aher College of Engineering, Karad
Accredited by NAAC with B+ & ISO 9001-2008 Certified Institute
Training & Placement Cell

AGTIs / DACOE/TPO/2022-2023/

Date: 11/10/2022

Aptitude Training Notice

All the students of T. Y. B. Tech –CSE, ENTC, MECH, & CIVIL batch, are hereby informed to note that **Aptitude Training-** by Mr. Rohit Patil, Skillogic is scheduled for preparation for campus placement. This training is very much crucial for the student's campus placement. All the student should attend the training as per the following schedule. **The attendance is compulsory for all the students.**

Time: 9:30 am to 5:30 pm

Lunch Break: 1:00 pm to 2:00 pm









Overall Coordination: Ms. R. A. Katkar

Sr.No.	Date & Time	Class & Branch	Venue	Coordinators
1	14/10/2022	T.Y.- CIVIL & CSE	CR- 18 Mech.Dept.	Mr. S. P. Chavan Ms. A. R. Kadve
2	15/10/2022	T.Y.- MECH & ENTC	CR- 18 Mech.Dept.	Mr. V. D. Yadav Ms. B. S. Kadam

Prof. H. M. Kumbhar
Vice- Principal

Dr. Anwar M. Mulla
Principal

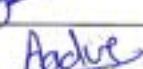
Cc:

Dean- Academics		TPO	
HOD - MECH		HOD - CSE	
HOD - EXTC		HOD - CIVIL	
TPC - MECH		TPC - CSE	
TPC - EXTC		TPC - CIVIL	



Dr. Ashok Gujar Technical Institute's
Dr. Daulatrao Aher College of Engineering, Karad
Aptitude Training for TY - All Branches
Date : 15/10/2022 Venue: CR- 18 Mech. Dept.
Time: 9.30am to 5.30 pm

Sr.No	Complete Name	Mob. No.	Branch	Sign.Session-I	Sign.Session-II
1	Abhishek S Pawar	9579352526	MECH	<i>Abhishek</i>	<i>Abhishek</i>
2	Balawant A Jadhav	8530115806	MECH		
3	Bobade Mahesh Sadashiv		MECH		
4	Dingane Omkar Shivaji	8830444197	MECH	<i>OSD</i>	<i>OSD</i>
5	Gavate Shreyas Mahesh		MECH		
6	Himanshu Devbhushan A	7588333162	MECH	<i>Himanshu</i>	<i>Himanshu</i>
7	Jamale Tushar Nathuram	9370518219	MECH	<i>Jamale</i>	<i>Jamale</i>
8	Lohar Vedant Bhaskar		MECH		
9	More Pratik Satish	8010762605	MECH	<i>More</i>	<i>More</i>
10	Patil Sangram Maruti		MECH	<i>Patil</i>	<i>Patil</i>
11	Prathamesh Mukund G		MECH	<i>Prathamesh</i>	<i>Prathamesh</i>
12	Ratan P Thorat		MECH		
13	Sande Sajid Jahangir		MECH		
14	Shubham Shivaji Thorat		MECH		
15	Patil Saurabh Shankar		MECH		
16	Attar Namira Ayub		MECH		
17	Kamble Prajka Shantaram		MECH		
18	Jagtap Pragati Pratap		MECH		
19	Devgan Vaishnavi A	9881139280	MECH	<i>Devgan</i>	<i>Devgan</i>
20	Patel Arshiya Tajuddin	9209265857	MECH	<i>Patel</i>	<i>Patel</i>
21	Kaware Kalyani Balaso	8010425696	MECH		
22	Gadave Rutuja Rajendra	9146494964	MECH	<i>Gadave</i>	<i>Gadave</i>
23	Patil Sayali Tukaram		MECH	<i>Patil</i>	<i>Patil</i>
24	Patel Aavej Vahid	9834204940	MECH	<i>Patel</i>	<i>Patel</i>
25	Dhavade Tejas C	7040983522	MECH	<i>Dhavade</i>	<i>Dhavade</i>
26	Patel Shoyab Altaf	7020067826	MECH	<i>S.Patel</i>	<i>S.Patel</i>
27	Soheb Jabbar Bagwan	7559324810	MECH	<i>S.J.Bagwan</i>	<i>S.J.Bagwan</i>
28	Lad Ruchika Rajendra	9359778793	MECH		
29	Kadam Suhas Suresh		MECH		
30	Madane Omkar Mukund	9730329809	MECH		
31	Keluskar Atharav Rajendra		MECH		
32	Kamble Aditya Dilip		MECH		
33	Kumbhar Avishkar S	7057831609	MECH	<i>Kumbhar</i>	<i>Kumbhar</i>
34	Jadhav Romesha Adhikrao		MECH		
35	Jadhav Jaydip Ganesh		MECH		
36	Kutte Mayuresh M		MECH		
37	Patil Indrajeet Satish		MECH		
38	Kanade Kaustubh Avinash		MECH		
39	Patil Shivraj Sandeep		MECH		

Sr.No	Complete Name	Mob. No.	Branch	Sign.Session-I	Sign.Session-II
40	Sabale Aryan Satyawan		MECH		
41	Pawar Ranjeet Satish		MECH		
42	Desai Shivam Ashok	8432196358	MECH	<i>Desai</i>	<i>Desai</i>
43	Shaikh Umar Samir		MECH		
44	Bhingardeve Rushikesh R		MECH		
45	Mahadik Aniruddha A		MECH		
46	Patil Ganesh Sambhaji		MECH		
47	Kokare Vishwajeet S		MECH		
48	Sonavane Prathamesh Biju		MECH		
49	Velhal Rutvik Sunil	9156992957	MECH	<i>Velhal</i>	
50	Pol Shivam Rajendra		MECH		
51	Sonavale Satyam Mohan		MECH		
52	Choudhari Akash A		MECH		
53	Nalawade Sagar Sunil		MECH		
54	Nalawade Akshay Dinkar		MECH		
55	Manie Manthan Vidhyanath		MECH		
56	Thakur Darshankumar S		MECH		
57	Shaikh Faizal Gaibesab		MECH		
58	Dhumal Rohit Mohan		MECH		
59	Jadhav Tejas Jaykar		MECH		
60	Dubal Dinesh Sudhakar		MECH		
61	Bandal Ajinkyadev Arun		MECH		
62	Sutar Bhalchandra Prakash		MECH		
63	Torane Abhishek Hanmant		MECH		
64	Mulik Vinayak Vijay		MECH		
65	Nikam Hrishikesh Kuldip	9284313241	MECH	<i>Nikam</i>	
66	Matekar Amar Yashwant		MECH		
67	Shinde Omkar Vilas		MECH		
68	Gaikwad Santosh D		MECH		
69	Pawar Suraj Shivaji		MECH		
70	Sawant Sairaj Suresh		MECH		
71	Gurav Ajinkya Ramesh		MECH		
72					
73					
74					
75					
76					
77					
78					
79					
80					
81					
82					
83					
84					
85					



Dr. Ashok Gujar Technical Institute's
Dr. Daulatrao Aher College of Engineering, Karad
Aptitude Training for TY - All Branches
Date : 15/10/2022 Venue: CR- 18 Mech. Dept.
Time: 9.30am to 5.30 pm

Sr.No	Complete Name	Mob. No.	Branch	Sign.Session-I	Sign.Session-II
1	BhingardeveVidhya .G	7769882534	ENTC		
2	Dsouza Venissa Prakash	7058286016	ENTC		
3	Jadhav Yashshree Prashant		ENTC		
4	Shetty Gautami Avinash	9623140669	ENTC		
5	Patil Shruti Rajaram	9172370019	ENTC		
6	Mane Vaishnavi Jeevan	7558663262	ENTC		
7	Patil Rutuja Dilip	7020558900	ENTC		
8	Patil Satyajit Ashok		ENTC		
9	Patil Shivraj Shashikant		ENTC		
10	Mane Prakash Jaysing		ENTC		
11	Kashid Sanket Maruti		ENTC		
12	Chavan Gayatri Laxman		ENTC		
13	Patel Afsana Rashid	9689235301	ENTC		
14	Magdum Swapnali Vilas	7083796588	ENTC		
15	Mane Shweta Sunil	9325285441	ENTC		
16	Lade Anamika Dipak		ENTC		
17	Patil Aditi Rajendra		ENTC		
18	Pawar Pranita Appaso		ENTC		
19	Shinde Vaishnavi B		ENTC		
20	Lole Rutika Sambhaji		ENTC		
21	Patil Gauri Tanaji	9579551051	ENTC		
22	Jadhav Aishwarya Abaso	9561489377	ENTC		
23	Thapa Durva Chandrakant	9322657390	ENTC		
24	Salave Dipti Bhimarao	9356564212	ENTC		
25	Lade Tanvi Sandesh	7038130510	ENTC		
26	Shinde Vaishnavi Vikas	7821570959	ENTC		
27	Kashilkar Shreya Dhananjay		ENTC		
28	Todkar Shradha Jitendra		ENTC		
29	Chavan Shivani Sayaji		ENTC		
30	Pawar Gayatri Suhas		ENTC		
31	Jadhav Sakshi Dattaji		ENTC		
32	Nikam Pranav Subhash		ENTC		
33	Phalle Bhagavant Anil		ENTC		
34	Pawar Ganesh Mohan		ENTC		
35	Kachare Harshavardhan J.		ENTC		
36	Kanase Aditya Ashok	9309210798	ENTC		
37	Mulla Muskan Iqbal		ENTC		
38	Sayyad Siddiq Nijam		ENTC		
39	Ghutugade Sanket Sambhaji	9016113038	ENTC		
40	Nalawade Rushikesh .R		ENTC		



Dr. Ashok Gujar Technical Institute's
Dr. Daulatrao Aher College of Engineering, Karad
Aptitude Training for TY - All Branches
Date : 14/10/2022 Venue: CR- 18 Mech. Dept.
Time: 9.30am to 5.30 pm

Sr.No	Complete Name	Mob. No.	Branch	Sign.Session-I	Sign.Session-II
1	Attar Ajnan Dastagir		CIVIL		
2	Babar Akshay Jaysing		CIVIL		
3	Baing Aniket Shankar		CIVIL		
4	Bamane Sanket Bhaskar	9370890213	CIVIL		
5	Bhagwat Akash Jaywant	9136050503	CIVIL		
6	Bhandwalkar Omkar Mahadev	8605661217	CIVIL		
7	Bhasme Aishwarya. C	9284188395	CIVIL		
8	Bhat Samruddhi Sagar	8263853605	CIVIL		
9	Bhoi Rohit Anil		CIVIL		
10	Bhopate Nilesh Mohan		CIVIL		
11	Chalke Abhishek Eknath		CIVIL		
12	Channe Shubham Shankar		CIVIL		
13	Chavan Abhijit Suresh		CIVIL		
14	Chavan Omkar Shivaji		CIVIL		
15	Chavan Rutuja Sambhajirao	8585253012	CIVIL		
16	Chavan Sunil Rajaram	9223247613	CIVIL		
17	Desai Suraj Shivaji		CIVIL		
18	Deshmukh Saurabh Rajendra	8767474263	CIVIL		
19	Devlekar Nitraj Nitin		CIVIL		
20	Dhulugade Pratik Shankar		CIVIL		
21	Dingane Prachi Rajendra	8888064325	CIVIL		
22	Falke Akanksha Ashok	7499134848	CIVIL		
23	Ghadage Prithviraj Sarjerao	735029209	CIVIL		
24	Gharge Sameer Rajendra	7774062426	CIVIL		
25	Jadhav Bhagyashree Ravindra		CIVIL		
26	Jadhav Dhiraj Shahaji	7620976798	CIVIL		
27	Jadhav Pranit Sunil		CIVIL		
28	Jadhav Shraddha Mahesh	8482802402	CIVIL		
29	Jadhav Uday Arun		CIVIL		
30	Jadhav Vishwajeet Shashikant	8698230196	CIVIL		
31	Jagdale Shivendra Rajendra		CIVIL		
32	Jagtap Gaurav Dhananjay		CIVIL		
33	Janrao Sandhya Kishor	9145665872	CIVIL		
34	Janugade Pranav Anandrao	9145787662	CIVIL		
35	Jujar Tejaswi Suresh	8010503075	CIVIL		
36	Kachare Avadhut Kamalakar	9545835741	CIVIL		
37	Kachhi Aman Ayub	7887784666	CIVIL		
38	Kadam Adiyta Sushilkumar	9960701952	CIVIL		
39	Kadam Akshay Jagannth		CIVIL		
40	Kadam Anuja Chandrakant	80803573196	CIVIL		



Dr. Ashok Gujar Technical Institute's
Dr. Daulatrao Aher College of Engineering, Karad
Aptitude Training for TY - All Branches
Date : 14/10/2022 Venue: CR- 18 Mech. Dept.
Time: 9.30am to 5.30 pm

Sr.No	Complete Name	Mob. No.	Branch	Sign. Session-I	Sign. Session-II
1	Acharya Prathmesh Prasad		CSE		
2	Bagwan Kamil M Rafique	8482915286	CSE	Kam/Bagwan	Kam/Bagwan
3	Bansode Vidya Pravin	8010491990	CSE		
4	Chavan Prashant Yuvraj	7410598085	CSE	Prashant	Prashant
5	Chavan Shubham Sanjay	9107171117	CSE	Shubham	Shubham
6	Chorage Ankita Chandrakant	7499201441	CSE	Ankita	Ankita
7	Chorage Pratik Arjun	8010719163	CSE	Chorage	Chorage
8	Christiyan Shine Jayan		CSE		
9	Couto Glenn Gilbert		CSE		
10	Chavan Tejaswini Dilip	8010814671	CSE	Tejaswini	Tejaswini
11	Desai Rohan Ramesh		CSE		
12	Gadale Snehal Krishna	7757809415	CSE	Gadale	Gadale
13	Gawade Komal Kiran	7304122863	CSE	Gawade	Gawade
14	Gurav Aishwarya Rajendra	9922513571	CSE	Gurav	Gurav
15	Inamdar Diya Ramjan	7709102458	CSE	Inamdar	Inamdar
16	Inamdar Zaid Salim	8329631425	CSE		
17	Jadhav Snehal Sanjay	7264038042	CSE	Jadhav	Jadhav
18	Kadam Sakshi Milind	7020541437	CSE	Sakshi	Sakshi
19	Kalaskar Abhishek Pandit	9850073968	CSE	Kalaskar	Kalaskar
20	Kamble Pooja Babasaheb	9325091466	CSE	Kamble	Kamble
21	Karale Aakanksha C	9075105104	CSE	Karale	Karale
22	Karande Neha Ganesh	7757882932	CSE	Karande	Karande
23	Kate Asmita Yuvraj	9552458004	CSE	Kate	Kate
24	Katu Omkar Baban	9763953178	CSE	Katu	Katu
25	Kharat Minal Sudam		CSE		
26	Khot Shruti Sharad		CSE		
27	Kodulkar Omkar Arun	7517752204	CSE	Kodulkar	Kodulkar
28	Kumbhar Prathmesh Popat	9561841929	CSE	Kumbhar	Kumbhar
29	Lawand Manasi Mahesh	7058586833	CSE	Lawand	Lawand
30	Lohar Prajakta Prakash	7020421530	CSE	Lohar	Lohar
31	Mahadik Viraj Nitin	8975779161	CSE	Mahadik	Mahadik
32	Mahajan Mukti Premchand	9373946505	CSE	Mahajan	Mahajan
33	Mane Sanket Shinabhau	9359006510	CSE	Mane	Mane
34	Mohite Gaurav Ramdas	9021354203	CSE	Mohite	Mohite
35	Moolya Nidhish Narayan	9370217137	CSE	Moolya	Moolya
36	Mujawar Rizwan Abid	9975919156	CSE	Mujawar	Mujawar
37	Mujawar Saad Najir	7391942667	CSE		
38	Mujawar Sayama Dilawar	7720044636	CSE		
39	Mulla Suhan Jameer	9975488562	CSE	Mulla	
40	Nagmal Prathamesh Yuvraj		CSE		

Sr.No	Complete Name	Mob. No.	Branch	Sign. Session-I	Sign. Session-II
41	Nalawade Rutuja Jagannath		CSE		
42	Nalawade Sanika Anil	9322766875	CSE		
43	Pakhale Omkar Santosh	85305241497	CSE	<u>Om</u>	<u>Om</u>
44	Patil Mrunali Ashok		CSE		
45	Patil Pranjali Sanjay	9423453023	CSE	<u>Pranjali</u>	<u>Pranjali</u>
46	Patil Saylee Sanjay	9766652699	CSE	<u>Saylee</u>	
47	Patil Vaishnavi Ashok	7498409271	CSE		
48	Patil Mrunal Mahesh	9379501711	CSE	<u>Mrunal</u>	<u>Mrunal</u>
49	Patil Pranjali Pradip	8685037156	CSE	<u>Pranjali</u>	<u>Pranjali</u>
50	Patil Sakshi Mohan	9172396016	CSE	<u>Sakshi</u>	
51	Patil Shreya Dadaso	9021102310	CSE	<u>Shreya</u>	<u>Shreya</u>
52	Patil Suyash Jivan	7066813773	CSE	<u>Suyash</u>	<u>Suyash</u>
53	Patil Vishal Ramkrishna	9730220101	CSE	<u>Vishal</u>	<u>Vishal</u>
54	Patole Shravani Mahesh		CSE		
55	Pawar Mayur Pratap	9359298530	CSE	<u>Mayur</u>	<u>Mayur</u>
56	Pawar Dhanashri Nitin	9022449491	CSE	<u>Dhanashri</u>	<u>Dhanashri</u>
57	Pawar Harshali Madan		CSE		
58	Pawar Pratik Shankar	7219415049	CSE	<u>Pratik</u>	<u>Pratik</u>
59	Poojary Varsha Vasantha	9588650699	CSE	<u>Varsha</u>	<u>Varsha</u>
60	Pawar Kajal Krishnat	7666005251	CSE	<u>Kajal</u>	
61	Reke Parth Pradeep		CSE		
62	Salunkhe Rucha Sandesh	8010821614	CSE	<u>Rucha</u>	<u>Rucha</u>
63	Sarang Trupti Balaji	8855827719	CSE		
64	Shedage Gauri Dhanaji	8550987006	CSE	<u>Gauri</u>	<u>Gauri</u>
65	Shejwal Archana Raju	8485856454	CSE	<u>Archana</u>	<u>Archana</u>
66	Shete Sakshi Dhananjay	8966452047	CSE	<u>Sakshi</u>	<u>Sakshi</u>
67	Shikalgar Juned Kamruddin	8169007031	CSE	<u>Juned</u>	<u>Juned</u>
68	Shinde Sanika Sandeep	9860851711	CSE	<u>Sanika</u>	<u>Sanika</u>
69	Shinde Sanika Sanjay	9356107975	CSE	<u>Sanika</u>	<u>Sanika</u>
70	Shinde Tanmay Balkrishna	9561513921	CSE	<u>Tanmay</u>	
71	Shirsat Salonee Pravin		CSE		
72	Sonawale Sakshi Baburao	7391915503	CSE	<u>Sonawale</u>	<u>Sonawale</u>
73	Shaikh Alfiya Asif		CSE		
74	Tandale Pradnya Mahesh	9666344399	CSE	<u>Pradnya</u>	<u>Pradnya</u>
75	Vetal Shivanjali Ramrao	8010118088	CSE	<u>Shivanjali</u>	<u>Shivanjali</u>
76	Yadav Pratiksha Balasaheb	70281720289	CSE	<u>Pratiksha</u>	<u>Pratiksha</u>



Mr. Rohit Patil



16
09

G. K. Gujar Memorial Charitable Trust's
Dr. Ashok Gujar Technical Institute's
Dr. Daulatrao Aher College of Engineering, Karad
Accredited by NAAC with B+ & ISO 9001-2008 Certified Institute
Training & Placement Cell

AGTIs / DACOE/TPO/2022-2023/

Date: 01/11/2022

Aptitude Training Notice

All the students of T. Y. B. Tech –CSE, ENTC, MECH, & CIVIL batch, are hereby informed to note that **Aptitude Training-** by Mr. Rohit Patil, Skillogic is scheduled for preparation for campus placement. This training is very much crucial for the student's campus placement. All the student should attend the training as per the following schedule. **The attendance is compulsory for all the students.**

Time: 9:30 am to 5:30 pm







Lunch Break: 1:00 pm to 2:00 pm

Overall Coordination: Ms. R. A. Katkar

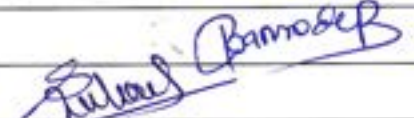
Sr.No.	Date & Time	Class & Branch	Venue	Coordinators
1	04/11/2022	T.Y.- CIVIL & CSE	CR- 18 Mech.Dept.	Mr. S. P. Chavan Ms. A. R. Kadve
2	05/11/2022	T.Y.- MECH & ENTC	CR- 18 Mech.Dept.	Mr. V. D. Yadav Ms. B. S. Kadam
3	11/11/2022	T.Y.- MECH & ENTC	CR- 18 Mech.Dept.	Mr. V. D. Yadav Ms. B. S. Kadam
4	12/11/2022	T.Y.- CIVIL & CSE	CR- 18 Mech.Dept.	Mr. S. P. Chavan Ms. A. R. Kadve

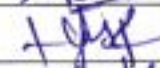
Prof. H. M. Kumbhar
Vice- Principal
Cc:

Dr. Anwar M. Mulla
Principal

Dean- Academics		TPO	
HOD - MECH		HOD - CSE	
HOD - EXTC		HOD - CIVIL	
TPC - MECH		TPC - CSE	
TPC - EXTC		TPC - CIVIL	



G. K. Gujar Memorial Charitable Trust's
Dr. Ashok Gujar Technical Institute's
Dr. Daulatrao Aher College of Engineering, Karad
Accredited by NAAC with B+ & ISO 9001-2008 Certified Institute
Training & Placement Cell

AGTIs / DACOE/TPO/2022-2023/

Date: 01/11/2022

Aptitude Training Notice

All the students of T. Y. B. Tech –CSE, ENTC, MECH, & CIVIL batch, are hereby informed to note that Aptitude Training- by Mr. Rohit Patil, Skilllogie is scheduled for preparation for campus placement. This training is very much crucial for the student's campus placement. All the student should attend the training as per the following schedule. The attendance is compulsory for all the students.

Time: 9:30 am to 5:30 pm

Lunch Break: 1:00 pm to 2:00 pm

Overall Coordination: Ms. R. A. Katkar

Sr.No.	Date & Time	Class & Branch	Venue	Coordinators
1	04/11/2022	T.Y.- CIVIL & CSE	CR- 18 Mech.Dept.	Mr. S.P. Chavan Ms. A. R. Kadve
2	05/11/2022	T.Y.- MECH & ENTC	CR- 18 Mech.Dept.	Mr. V. D. Yadav Ms. B. S. Kadam
3	11/11/2022	T.Y.- MECH & ENTC	CR- 18 Mech.Dept.	Mr. V. D. Yadav Ms. B. S. Kadam
4	12/11/2022	T.Y.- CIVIL & CSE	CR- 18 Mech.Dept.	Mr. S. P. Chavan Ms. A. R. Kadve

Prof. H. M. Kumbhar
Vice- Principal

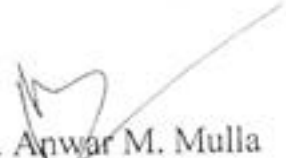
Dr. Anwar M. Mulla
Principal

Cc:

Dean- Academics	TPO
HOD - MECH	HOD - CSE
HOD - EXTC	HOD - CIVIL
TPC - MECH	TPC - CSE
TPC - EXTC	TPC - CIVIL



Dr. Ashok Gujar Technical Institute's
Dr. Daulatrao Aher College of Engineering, Karad
Aptitude Training for TY - All Branches
Date : 04/11/2022 Venue: CR- 18 Mech. Dept.
Time: 9.30am to 5.30 pm

Sr.No	Complete Name	Mob. No.	Branch	Sign.Session-I	Sign.Session-II
1	Attar Ajnan Dastagir		CIVIL		
2	Babar Akshay Jaysing		CIVIL		
3	Baing Aniket Shankar		CIVIL		
4	Bamane Sanket Bhaskar	9370890213	CIVIL		
5	Bhagwat Akash Jaywant	9136050503	CIVIL		
6	Bhandwalkar Omkar Mahadev	8605661217	CIVIL	Om	
7	Bhasme Aishwarya. C	9284188395	CIVIL	Abh	Abh
8	Bhat Samruddhi Sagar	8263853605	CIVIL	Abh	
9	Bhoi Rohit Anil		CIVIL		
10	Bhopate Nilesh Mohan		CIVIL		
11	Chalke Abhishek Eknath		CIVIL		
12	Channe Shubham Shankar		CIVIL		
13	Chavan Abhijit Suresh		CIVIL		
14	Chavan Omkar Shivaji		CIVIL		
15	Chavan Rutuja Sambhajirao	8585253012	CIVIL	PS	PS
16	Chavan Sunil Rajaram	9223247613	CIVIL	SE	
17	Desai Suraj Shivaji		CIVIL		
18	Deshmukh Saurabh Rajendra	8767474263	CIVIL		
19	Devlekar Nitraj Nitin		CIVIL		
20	Dhulugade Pratik Shankar		CIVIL		
21	Dingane Prachi Rajendra	8888064325	CIVIL		
22	Falke Akanksha Ashok	7499134848	CIVIL	Alake	Alake
23	Ghadage Prithviraj Sarjerao	735029209	CIVIL	PS	
24	Gharge Sameer Rajendra	7774062426	CIVIL		
25	Jadhav Bhagyashree Ravindra		CIVIL		
26	Jadhav Dhiraj Shahaji	7620976798	CIVIL	Jadhav	
27	Jadhav Pranit Sunil		CIVIL		
28	Jadhav Shraddha Mahesh	8482802402	CIVIL	Shraddha	Shraddha
29	Jadhav Uday Arun		CIVIL		
30	Jadhav Vishwajeet Shashikant	8698230196	CIVIL		
31	Jagdale Shivendra Rajendra		CIVIL		
32	Jagtap Gaurav Dhananjay		CIVIL		
33	Janrao Sandhya Kishor	9145665872	CIVIL	Janrao	Janrao
34	Janugade Pranav Anandrao	9145787662	CIVIL	Pranav	
35	Jujar Tejaswi Suresh	8010503075	CIVIL	Tejaswi	Tejaswi
36	Kachare Avadhut Kamalakar	9545835741	CIVIL	Ak	
37	Kachhi Aman Ayub	7887784666	CIVIL		
38	Kadam Aditya Sushilkumar	9960701952	CIVIL		
39	Kadam Akshay Jagannth		CIVIL		
40	Kadam Anuja Chandrakant	80803573196	CIVIL		



Dr. Ashok Gujar Technical Institute's
Dr. Daulatrao Aher College of Engineering, Karad
Aptitude Training for TY - All Branches
Date : 04/11/2022 Venue: CR- 18 Mech. Dept.
Time: 9.30am to 5.30 pm

Sr.No	Complete Name	Mob. No.	Branch	Sign. Session-I	Sign. Session-II
1	Acharya Prathmesh Prasad		CSE		
2	Bagwan Kamil M Rafique	8482915286	CSE		
3	Bansode Vidya Pravin	8010491990	CSE		
4	Chavan Prashant Yuvraj	7410598085	CSE		
5	Chavan Shubham Sanjay	9107171117	CSE		
6	Chorage Ankita Chandrakant	7499201441	CSE		
7	Chorage Pratik Arjun	8010719163	CSE		
8	Christiyan Shine Jayan		CSE		
9	Couto Glenn Gilbert		CSE	<i>Glenn</i>	
10	Chavan Tejaswini Dilip	8010819671	CSE	<i>Tejaswini</i>	<i>Tejaswini</i>
11	Desai Rohan Ramesh		CSE		
12	Gadale Snehal Krishna	7757809415	CSE	<i>Snehal</i>	<i>Snehal</i>
13	Gawade Komal Kiran	7304122863	CSE	<i>Komal</i>	
14	Gurav Aishwarya Rajendra	9922513571	CSE		
15	Inamdar Diya Ramjan	7709102458	CSE	<i>Diya</i>	
16	Inamdar Zaid Salim	8329631425	CSE	<i>Zaid</i>	
17	Jadhav Snehal Sanjay	7264038042	CSE	<i>Snehal</i>	
18	Kadam Sakshi Milind		CSE	<i>Sakshi</i>	
19	Kalaskar Abhishek Pandit	9850073968	CSE	<i>Abhishek</i>	
20	Kamble Pooja Babasaheb	9325091466	CSE		
21	Karale Aakanksha C	9075105104	CSE	<i>Aakanksha</i>	<i>Aakanksha</i>
22	Karande Neha Ganesh	7757882932	CSE	<i>Neha</i>	<i>Neha</i>
23	Kate Asmita Yuvraj	9552458004	CSE	<i>Asmita</i>	
24	Katu Omkar Baban		CSE		
25	Kharat Minal Sudam		CSE		
26	Khot Shruti Sharad		CSE	<i>Shruti</i>	<i>Shruti</i>
27	Kodulkar Omkar Arun	7517752204	CSE		
28	Kumbhar Prathmesh Popat	9561841929	CSE	<i>Prathmesh</i>	<i>Prathmesh</i>
29	Lawand Manasi Mahesh	7058586833	CSE	<i>Manasi</i>	<i>Manasi</i>
30	Lohar Prajakta Prakash	7020421530	CSE	<i>Prajakta</i>	<i>Prajakta</i>
31	Mahadik Viraj Nitin	8975779161	CSE		
32	Mahajan Mukti Premchand	9373946505	CSE	<i>Mukti</i>	
33	Mane Sanket Shinabhau	9359006510	CSE		
34	Mohite Gaurav Ramdas	9021354203	CSE	<i>Gaurav</i>	<i>Gaurav</i>
35	Moolya Nidhish Narayan	9370217137	CSE	<i>Nidhish</i>	
36	Mujawar Rizwan Abid	9975919156	CSE	<i>Rizwan</i>	
37	Mujawar Saad Najir	7391942667	CSE		
38	Mujawar Sayama Dilawar	7720044636	CSE	<i>Sayama</i>	
39	Mulla Suhan Jameer	9975488562	CSE		
40	Nagmal Prathamesh Yuvraj		CSE		

Sr.No	Complete Name	Mob. No.	Branch	Sign. Session-I	Sign. Session-II
41	Nalawade Rutuja Jagannath		CSE	Rnalawade	Rnalawade
42	Nalawade Sanika Anil	9322766875	CSE	SA	
43	Pakhale Omkar Santosh	85305241497	CSE		
44	Patil Mrunali Ashok		CSE		
45	Patil Pranjali Sanjay	9423453023	CSE	Pranjali	
46	Patil Saylee Sanjay	9766652699	CSE	Patil	
47	Patil Vaishnavi Ashok	7498409271	CSE	Vpaw	
48	Patil Mrunal Mahesh		CSE	Patil	
49	Patil Pranjali Pradip	8585037156	CSE	PPPatil	PPPatil
50	Patil Sakshi Mohan	9172396016	CSE	Patil	Patil
51	Patil Shreya Dadaso	9021102310	CSE	Pa	Patil
52	Patil Suyash Jivan	7066813773	CSE	Patil	Patil
53	Patil Vishal Ramkrishna	9730220101	CSE		
54	Patole Shrivani Mahesh		CSE	Shrivani	
55	Pawar Mayur Pratap	9359298530	CSE		
56	Pawar Dhanashri Nitin	9022449491	CSE	Pawar	Pawar
57	Pawar Harshali Madan	9975350496	CSE	HPawar	
58	Pawar Pratik Shankar	7219415049	CSE		
59	Poojary Varsha Vasantha	9588650699	CSE	Varsha	Varsha
60	Pawar Kajal Krishnat	7666005271	CSE	Kpawar	
61	Reke Parth Pradeep		CSE		
62	Salunkhe Rucha Sandesh	8010821614	CSE	Rucha	
63	Sarang Trupti Balaji	8855827719	CSE	Trupti	
64	Shedage Gauri Dhanaji	8550987006	CSE	Gauri	Gauri
65	Shejwal Archana Raju	8485856454	CSE	Archana	
66	Shete Sakshi Dhananjay	8966452047	CSE		
67	Shikalgar Juned Kamruddin	8169007031	CSE		
68	Shinde Sanika Sandeep	9860851711	CSE	Shinde	Shinde
69	Shinde Sanika Sanjay	9356107975	CSE	Sanika	Sanika
70	Shinde Tanmay Balkrishna		CSE		
71	Shirsat Salonee Pravin	9834710741	CSE	Shirsat	
72	Sonawale Sakshi Baburao	7391915503	CSE	sonawale	sonawale
73	Shaikh Alfiya Asif	7385205397	CSE	Alfiya	
74	Tandale Pradnya Mahesh	9666344399	CSE	Tandale	Tandale
75	Vetal Shivanjali Ramrao	8010118088	CSE	Vetal	Vetal
76	Yadav Pratiksha Balasaheb	70281720289	CSE	Yadav	Yadav



Dr. Ashok Gujar Technical Institute's
Dr. Daulatrao Aher College of Engineering, Karad
Aptitude Training for TY - All Branches
Date : 05/11/2022 Venue: CR- 18 Mech. Dept.
Time: 9.30am to 5.30 pm

Sr.No	Complete Name	Mob. No.	Branch	Sign.Session-I	Sign.Session-II
1	Abhishek S Pawar	9579352526	MECH		
2	Balawant A Jadhav	8530115806	MECH		
3	Bobade Mahesh Sadashiv		MECH		
4	Dingane Omkar Shivaji	8830444197	MECH		
5	Gavate Shreyas Mahesh		MECH		
6	Himanshu Devbhushan A	7588333162	MECH	<i>Abhishek</i>	<i>Abhishek</i>
7	Jamale Tushar Nathuram	9370518219	MECH		
8	Lohar Vedant Bhaskar		MECH		
9	More Pratil Satish	8010762605	MECH		
10	Patil Sangram Maruti		MECH		
11	Prathamesh Mukund G		MECH		
12	Ratan P Thorat		MECH		
13	Sande Sajid Jahangir		MECH		
14	Shubham Shivaji Thorat		MECH		
15	Patil Saurabh Shankar		MECH		
16	Attar Namira Ayub		MECH		
17	Kamble Prajka Shantaram		MECH		
18	Jagtap Pragati Pratap		MECH		
19	Devgan Vaishnavi A	9881139280	MECH		
20	Patel Arshiya Tajuddin	9209265857	MECH	<i>Arshiya Patel</i>	<i>Arshiya Patel</i>
21	Kaware Kalyani Balaso	8010425696	MECH		
22	Gadave Rutuja Rajendra	9146494964	MECH		
23	Patil Sayali Tukaram		MECH		
24	Patel Aavej Vahid	9834204940	MECH	<i>Aavej Patel</i>	<i>Aavej Patel</i>
25	Dhavade Tejas C	7040983522	MECH		
26	Patel Shoyab Altaf	7020067826	MECH	<i>S.Patel</i>	<i>S.Patel</i>
27	Soheb Jabbar Bagwan	7559324810	MECH	<i>S. J. Bagwan</i>	<i>S. J. Bagwan</i>
28	Lad Ruchika Rajendra	9359778793	MECH		
29	Kadam Suhas Suresh		MECH		
30	Madane Omkar Mukund	9730329809	MECH		
31	Keluskar Atharav Rajendra		MECH		
32	Kamble Aditya Dilip		MECH		
33	Kumbhar Avishkar S	7057831609	MECH		
34	Jadhav Romesha Adhikrao	9373139030	MECH	<i>Romesha</i>	<i>Romesha</i>
35	Jadhav Jaydip Ganesh		MECH		
36	Kutte Mayuresh M		MECH		
37	Patil Indrajeet Satish		MECH		
38	Kanade Kaustubh Avinash		MECH		
39	Patil Shivraj Sandeep		MECH		

Sr.No	Complete Name	Mob. No.	Branch	Sign.Session-I	Sign.Session-II
40	Sabale Aryan Satyawar		MECH		
41	Pawar Ranjeet Satish		MECH		
42	Desai Shivam Ashok	8432196358	MECH	<i>Desai</i>	<i>Desai</i>
43	Shaikh Umar Samir		MECH		
44	Bhingardeve Rushikesh R		MECH		
45	Mahadik Aniruddha A		MECH		
46	Patil Ganesh Sambhaji		MECH		
47	Kokare Vishwajeet S		MECH		
48	Sonavane Prathamesh Biju		MECH		
49	Velhal Rutvik Sunil	9156992957	MECH		
50	Pol Shivam Rajendra		MECH		
51	Sonavale Satyam Mohan		MECH		
52	Choudhari Akash A		MECH		
53	Nalawade Sagar Sunil		MECH		
54	Nalawade Akshay Dinkar		MECH		
55	Mane Manthan Vidhyanath		MECH		
56	Thakur Darshankumar S		MECH		
57	Shaikh Faizal Gaibesab		MECH		
58	Dhumal Rohit Mohan		MECH		
59	Jadhav Tejas Jaykar		MECH		
60	Dubal Dinesh Sudhakar		MECH		
61	Bandal Ajinkyadev Arun		MECH		
62	Sutar Bhalchandra Prakash		MECH		
63	Torane Abhishek Hanmant		MECH		
64	Mulik Vinayak Vijay		MECH		
65	Nikam Hrishikesh Kuldip	9284313241	MECH		
66	Matekar Amar Yashwant		MECH		
67	Shinde Omkar Vilas		MECH		
68	Gaikwad Santosh D		MECH		
69	Pawar Suraj Shivaji		MECH		
70	Sawant Sairaj Suresh		MECH		
71	Gurav Ajinkya Ramesh		MECH		
72					
73					
74					
75					
76					
77					
78					
79					
80					
81					
82					
83					
84					
85					



Dr. Ashok Gujar Technical Institute's
Dr. Daulatrao Aher College of Engineering, Karad
Aptitude Training for TY - All Branches
Date : 05/11/2022 Venue: CR- 18 Mech. Dept.
Time: 9.30am to 5.30 pm

Sr.No	Complete Name	Mob. No.	Branch	Sign.Session-I	Sign.Session-II
1	BhingardeveVidhya .G	7769882534	ENTC		
2	Dsouza Venissa Prakash	7058286016	ENTC		
3	Jadhav Yashshree Prashant		ENTC		
4	Shetty Gautami Avinash	9623140669	ENTC		
5	Patil Shruti Rajaram	9172370019	ENTC		
6	Mane Vaishnavi Jeevan	7558663262	ENTC		
7	Patil Rutuja Dilip	7020558900	ENTC		
8	Patil Satyajit Ashok		ENTC		
9	Patil Shivraj Shashikant		ENTC		
10	Mane Prakash Jaysing		ENTC		
11	Kashid Sanket Maruti		ENTC		
12	Chavan Gayatri Laxman		ENTC		
13	Patel Afsana Rashid	9689235301	ENTC		
14	Magdum Swapnali Vilas	7083796588	ENTC		
15	Mane Shweta Sunil	9325285441	ENTC		
16	Lade Anamika Dipak		ENTC		
17	Patil Aditi Rajendra		ENTC		
18	Pawar Pranita Appaso		ENTC		
19	Shinde Vaishnavi B		ENTC		
20	Lole Rutika Sambhaji		ENTC		
21	Patil Gauri Tanaji	9579551051	ENTC		
22	Jadhav Aishwarya Abaso	9561489377	ENTC		
23	Thapa Durva Chandrakant	9322657390	ENTC		
24	Salave Dipti Bhimarao	9356564212	ENTC		
25	Lade Tanvi Sandesh	7038130510	ENTC		
26	Shinde Vaishnavi Vikas	7821570959	ENTC		
27	Kashilkar Shreya Dhananjay		ENTC		
28	Todkar Shradha Jitendra		ENTC		
29	Chavan Shivani Sayaji		ENTC		
30	Pawar Gayatri Suhas		ENTC		
31	Jadhav Sakshi Dattaji		ENTC		
32	Nikam Pranav Subhash		ENTC		
33	Phalle Bhagavant Anil		ENTC		
34	Pawar Ganesh Mohan		ENTC		
35	Kachare Harshavardhan J.		ENTC		
36	Kanase Aditya Ashok	9309210798	ENTC		
37	Mulla Muskan Iqbal		ENTC		
38	Sayyad Siddiq Nijam		ENTC		
39	Ghutugade Sanket Sambhaji	9016113038	ENTC		
40	Nalawade Rushikesh .R		ENTC		

Sr.No	Complete Name	Mob. No.	Branch	Sign.Session-I	Sign.Session-II
41	Gharage Shivam Sanjay	9822303587	ENTC		
42	Desai Prathamesh Dattatray		ENTC		
43	Chavan Swapnali Mahadev		ENTC		
44	Kazi Ayan Nasir		ENTC		
45	Gurav Dattatray Dnyendev		ENTC		
46					
47					
48					
49					
50					
51					
52					
53					
54					
55					
56					
57					
58					
59					
60					
61					
62					
63					
64					
65					
66					
67					
68					
69					
70					
71					
72					
73					
74					
75					
76					
77					
78					
79					
80					
81					
82					
83					



Dr. Ashok Gujar Technical Institute's
Dr. Daulatrao Aher College of Engineering, Karad
Aptitude Training for TY - All Branches
Date : 11/11/2022 Venue: CR- 18 Mech. Dept.
Time: 9.30am to 5.30 pm

Sr.No	Complete Name	Mob. No.	Branch	Sign.Session-I	Sign.Session-II
1	Abhishek S Pawar	9579352526	MECH	<i>Abhishek</i>	
2	Balawant A Jadhav	8530115806	MECH	<i>Balawant</i>	<i>Balawant</i>
3	Bobade Mahesh Sadashiv		MECH	<i>Bobade</i>	
4	Dingane Omkar Shivaji	8830444197	MECH	<i>Omkar</i>	
5	Gavate Shreyas Mahesh		MECH		
6	Himanshu Devbhushan A	7588333162	MECH	<i>Himanshu</i>	<i>Himanshu</i>
7	Jamale Tushar Nathuram	9370518219	MECH	<i>Tushar</i>	
8	Lohar Vedant Bhaskar		MECH		
9	More Pratik Satish	8010762605	MECH	<i>Pratik</i>	<i>Pratik</i>
10	Patil Sangram Maruti		MECH	<i>Sangram</i>	
11	Prathamesh Mukund G		MECH		
12	Ratan P Thorat	7219497793	MECH	<i>R Thorat</i>	<i>R Thorat</i>
13	Sande Sajid Jahangir		MECH		
14	Shubham Shivaji Thorat		MECH		
15	Patil Saurabh Shankar		MECH		
16	Attar Namira Ayub		MECH		
17	Kamble Prajta Shantaram		MECH		
18	Jagtap Pragati Pratap		MECH		
19	Devgan Vaishnavi A	9881139280	MECH	<i>Devgan</i>	<i>Devgan</i>
20	Patel Arshiya Tajuddin	9209265857	MECH	<i>Arshiya</i>	<i>Arshiya</i>
21	Kaware Kalyani Balaso	8010425696	MECH		
22	Gadave Rutuja Rajendra	9146494964	MECH	<i>Gadave</i>	<i>Gadave</i>
23	Patil Sayali Tukaram		MECH		
24	Patel Aavej Vahid	9834204940	MECH	<i>Aavej</i>	<i>Aavej</i>
25	Dhayade Tejas C	7040983522	MECH	<i>Tejas</i>	<i>Tejas</i>
26	Patel Shoyab Altaf	7020067826	MECH	<i>S.Patel</i>	<i>S.Patel</i>
27	Soheb Jabbar Bagwan	7559324810	MECH	<i>S.J. Bagwan</i>	<i>S.J. Bagwan</i>
28	Lad Ruchika Rajendra	9359778793	MECH	<i>Ruchika</i>	<i>Ruchika</i>
29	Kadam Suhas Suresh		MECH		
30	Madane Omkar Mukund	9730329809	MECH		
31	Keluskar Atharav Rajendra	2359342108	MECH	<i>Atharav</i>	<i>Atharav</i>
32	Kamble Aditya Dilip	9922069754	MECH	<i>A Kamble</i>	<i>A Kamble</i>
33	Kumbhar Avishkar S	7057831609	MECH	<i>Avishkar</i>	<i>Avishkar</i>
34	Jadhav Romesha Adhikrao		MECH		
35	Jadhav Jaydip Ganesh		MECH		
36	Kutte Mayuresh M		MECH		
37	Patil Indrajeet Satish		MECH		
38	Kanade Kaustubh Avinash	8669109047	MECH	<i>Kanade</i>	<i>Kanade</i>
39	Patil Shivraj Sandeep		MECH		

Sr.No	Complete Name	Mob. No.	Branch	Sign.Session-I	Sign.Session-II
40	Sabale Aryan Satyawar		MECH		
41	Pawar Ranjeet Satish		MECH		
42	Desai Shivam Ashok	8432196358	MECH	<i>Desai</i>	<i>Desai</i>
43	Shaikh Umar Samir		MECH		
44	Bhingardeve Rushikesh R		MECH		
45	Mahadik Aniruddha A		MECH		
46	Patil Ganesh Sambhaji		MECH	<i>Patil</i>	<i>Patil</i>
47	Kokare Vishwajeet S		MECH	<i>Gokare</i>	<i>Gokare</i>
48	Sonavane Prathamesh Biju		MECH		
49	Velhal Rutvik Sunil	9156992957	MECH	<i>Rutvik</i>	<i>Rutvik</i>
50	Pol Shivam Rajendra		MECH		
51	Sonavale Satyam Mohan		MECH		
52	Choudhari Akash A		MECH		
53	Nalawade Sagar Sunil		MECH		
54	Nalawade Akshay Dinkar		MECH		
55	Mane Manthan Vidhyanath		MECH		
56	Thakur Darshankumar S		MECH		
57	Shaikh Faizal Gaibesab		MECH		
58	Dhumal Rohit Mohan		MECH		
59	Jadhav Tejas Jaykar		MECH		
60	Dubal Dinesh Sudhakar		MECH		
61	Bandal Ajinkyadev Arun		MECH		
62	Sutar Bhalchandra Prakash		MECH		
63	Torane Abhishek Hanmant		MECH		
64	Mulik Vinayak Vijay		MECH		
65	Nikam Hrishikesh Kuldip	9284313241	MECH		
66	Matekar Amar Yashwant		MECH		
67	Shinde Omkar Vilas		MECH		
68	Gaikwad Santosh D		MECH		
69	Pawar Suraj Shivaji		MECH		
70	Sawant Sairaj Suresh		MECH		
71	Gurav Ajinkya Ramesh		MECH		
72					
73					
74					
75					
76					
77					
78					
79					
80					
81					
82					
83					
84					
85					



Dr. Ashok Gujar Technical Institute's
Dr. Daulatrao Aher College of Engineering, Karad
Aptitude Training for TY - All Branches
Date : 11/11/2022 Venue: CR- 18 Mech. Dept.
Time: 9.30am to 5.30 pm

Sr.No	Complete Name	Mob. No.	Branch	Sign.Session-I	Sign.Session-II
1	BhingardeveVidhya .G	7769882534	ENTC		
2	Dsouza Venissa Prakash	7058286016	ENTC		
3	Jadhav Yashshree Prashant		ENTC		
4	Shetty Gautami Avinash	9623140669	ENTC		
5	Patil Shruti Rajaram	9172370019	ENTC		
6	Mane Vaishnavi Jeevan	7558663262	ENTC		
7	Patil Rutuja Dilip	7020558900	ENTC		
8	Patil Satyajit Ashok	9834907270	ENTC		
9	Patil Shivraj Shashikant	8530660503	ENTC		
10	Mane Prakash Jaysing	9529973955	ENTC		
11	Kashid Sanket Maruti		ENTC		
12	Chavan Gayatri Laxman		ENTC		
13	Patel Afsana Rashid	9689235301	ENTC		
14	Magdum Swapnali Vilas	7083796588	ENTC		
15	Mane Shweta Sunil	9325285441	ENTC		
16	Lade Anamika Dipak		ENTC		
17	Patil Aditi Rajendra		ENTC		
18	Pawar Pranita Appaso		ENTC		
19	Shinde Vaishnavi B		ENTC		
20	Lole Rutika Sambhaji		ENTC		
21	Patil Gauri Tanaji	9579551051	ENTC		
22	Jadhav Aishwarya Abaso	9561489377	ENTC		
23	Thapa Durva Chandrakant	9322657390	ENTC		
24	Salave Dipti Bhimarao	9356564212	ENTC		
25	Lade Tanvi Sandesh	7038130510	ENTC		
26	Shinde Vaishnavi Vikas	7821570959	ENTC		
27	Kashilkar Shreya Dhananjay		ENTC		
28	Todkar Shradha Jitendra		ENTC		
29	Chavan Shivani Sayaji		ENTC		
30	Pawar Gayatri Suhas		ENTC		
31	Jadhav Sakshi Dattaji		ENTC		
32	Nikam Pranav Subhash		ENTC		
33	Phalle Bhagavant Anil	9970698540	ENTC		
34	Pawar Ganesh Mohan		ENTC		
35	Kachare Harshavardhan J.	9923501425	ENTC		
36	Kanase Aditya Ashok	9309210798	ENTC		
37	Mulla Muskan Iqbal		ENTC		
38	Sayyad Siddiq Nijam		ENTC		
39	Ghutugade Sanket Sambhaji	9016113038	ENTC		
40	Nalawade Rushikesh .R		ENTC		

Sr.No	Complete Name	Mob. No.	Branch	Sign.Session-I	Sign.Session-II
41	Gharage Shivam Sanjay	9822303587	ENTC		
42	Desai Prathamesh Dattatray		ENTC		
43	Chavan Swapnali Mahadev		ENTC		
44	Kazi Ayan Nasir	8698824640	ENTC	ANKAN	ANKAN
45	Gurav Dattatray Dnyendev	7028809656	ENTC	Gurav	Gurav
46					
47					
48					
49					
50					
51					
52					
53					
54					
55					
56					
57					
58					
59					
60					
61					
62					
63					
64					
65					
66					
67					
68					
69					
70					
71					
72					
73					
74					
75					
76					
77					
78					
79					
80					
81					
82					
83					



Dr. Ashok Gujar Technical Institute's
Dr. Daulatrao Aher College of Engineering, Karad
Aptitude Training for TY - All Branches
Date : 12/11/2022 Venue: CR- 18 Mech. Dept.
Time: 9.30am to 5.30 pm

Sr.No	Complete Name	Mob. No.	Branch	Sign.Session-I	Sign.Session-II
1	Attar Ajnan Dastagir		CIVIL		
2	Babar Akshay Jaysing		CIVIL		
3	Baing Aniket Shankar		CIVIL		
4	Bamane Sanket Bhaskar	9370890213	CIVIL		
5	Bhagwat Akash Jaywant	9136050503	CIVIL		
6	Bhandwalkar Omkar Mahadev	8605661217	CIVIL		
7	Bhasme Aishwarya. C	9284188395	CIVIL		
8	Bhat Samruddhi Sagar	8263853605	CIVIL	<u>Bhat</u>	<u>Bhat</u>
9	Bhoi Rohit Anil		CIVIL		
10	Bhopate Nilesh Mohan		CIVIL		
11	Chalke Abhishek Eknath		CIVIL		
12	Channe Shubham Shankar		CIVIL		
13	Chavan Abhijit Suresh		CIVIL		
14	Chavan Omkar Shivaji		CIVIL		
15	Chavan Rutuja Sambhajirao	8585253012	CIVIL		
16	Chavan Sunil Rajaram	9223247613	CIVIL		
17	Desai Suraj Shivaji		CIVIL		
18	Deshmukh Saurabh Rajendra	8767474263	CIVIL		
19	Devlekar Nitraj Nitin		CIVIL		
20	Dhulugade Pratik Shankar		CIVIL		
21	Dingane Prachi Rajendra	8888064325	CIVIL		
22	Falke Akanksha Ashok	7499134848	CIVIL	<u>Falke</u>	<u>Falke</u>
23	Ghadage Prithviraj Sarjerao		CIVIL		
24	Gharge Sameer Rajendra	7774062426	CIVIL		
25	Jadhav Bhagyashree Ravindra		CIVIL		
26	Jadhav Dhiraj Shahaji	7620976798	CIVIL		
27	Jadhav Pranit Sunil		CIVIL		
28	Jadhav Shraddha Mahesh	8482802402	CIVIL		
29	Jadhav Uday Arun		CIVIL		
30	Jadhav Vishwajeet Shashikant	8698230196	CIVIL		
31	Jagdale Shivendra Rajendra		CIVIL		
32	Jagtap Gaurav Dhananjay		CIVIL		
33	Janrao Sandhya Kishor	9145665872	CIVIL	<u>Janrao</u>	<u>Janrao</u>
34	Janugade Pranav Anandrao	9145787662	CIVIL		
35	Jujar Tejaswi Suresh	8010503075	CIVIL	<u>Jujar</u>	<u>Jujar</u>
36	Kachare Avadhut Kamalakar	9545835741	CIVIL		
37	Kachhi Aman Ayub	7887784666	CIVIL		
38	Kadam Adiyta Sushilkumar	9960701952	CIVIL		
39	Kadam Akshay Jagannth		CIVIL		
40	Kadam Anuja Chandrakant	80803573196	CIVIL		



Dr. Ashok Gujar Technical Institute's
Dr. Daulatrao Aher College of Engineering, Karad
Aptitude Training for TY - All Branches
Date : 12/11/2022 Venue: CR- 18 Mech. Dept.
Time: 9.30am to 5.30 pm

Sr.No	Complete Name	Mob. No.	Branch	Sign. Session-I	Sign. Session-II
1	Acharya Prathmesh Prasad		CSE		
2	Bagwan Kamil M Rafique	8482915286	CSE	Karibans	Karibans
3	Bansode Vidya Pravin	8010491990	CSE		
4	Chavan Prashant Yuvraj	7410598085	CSE	chell	chav
5	Chavan Shubham Sanjay	9107171117	CSE		
6	Chorage Ankita Chandrakant	7499201441	CSE	Chorage	Chorage
7	Chorage Pratik Arjun	8010719163	CSE	Chorage	Chorage
8	Christiyan Shine Jayan		CSE	Shine	Shine
9	Couto Glenn Gilbert		CSE	Glenn	Glenn
10	Chavan Tejaswini Dilip	8010819671	CSE	Chavan	Chavan
11	Desai Rohan Ramesh		CSE		
12	Gadale Snehal Krishna	7757809415	CSE	Gadale	Gadale
13	Gawade Komal Kiran	7304122863	CSE	Gawade	Gawade
14	Gurav Aishwarya Rajendra	9922513571	CSE		
15	Inamdar Diya Ramjan	7709102458	CSE	Inamdar	Inamdar
16	Inamdar Zaid Salim	8329631425	CSE	Zaid	Zaid
17	Jadhav Snehal Sanjay	7264038042	CSE	Snehal	Snehal
18	Kadam Sakshi Milind		CSE	Sakshi	Sakshi
19	Kalaskar Abhishek Pandit	9850073968	CSE	Kalaskar	Kalaskar
20	Kamble Pooja Babasaheb	9325091466	CSE	Pooja	Pooja
21	Karale Aakanksha C	9075105104	CSE	Karale	Karale
22	Karande Neha Ganesh	7757882932	CSE	Neha	Neha
23	Kate Asmita Yuvraj	9552458004	CSE	Asmita	Asmita
24	Katu Omkar Baban		CSE	Omkar	Omkar
25	Kharat Minal Sudam		CSE	Minal	Minal
26	Khot Shruti Sharad		CSE	Shruti	Shruti
27	Kodulkar Omkar Arun	7517752204	CSE	Omkar	Omkar
28	Kumbhar Prathmesh Popat	9561841929	CSE	Prathmesh	Prathmesh
29	Lawand Manasi Mahesh	7058586833	CSE	Manasi	Manasi
30	Lohar Prajakta Prakash	7020421530	CSE	Prajakta	Prajakta
31	Mahadik Viraj Nitin	8975779161	CSE	Viraj	Viraj
32	Mahajan Mukti Premchand	9373946505	CSE	Mukti	Mukti
33	Mane Sanket Shinabhau	9359006510	CSE	Sanket	Sanket
34	Mohite Gaurav Ramdas	9021354203	CSE	Gaurav	Gaurav
35	Moolya Nidhish Narayan	9370217137	CSE	Nidhish	Nidhish
36	Mujawar Rizwan Abid	9975919156	CSE	Rizwan	Rizwan
37	Mujawar Saad Najir	7391942667	CSE	Saad	Saad
38	Mujawar Sayama Dilawar	7720044636	CSE	Sayama	Sayama
39	Mulla Suhan Jameer	9975488562	CSE	Suhan	Suhan
40	Nagmal Prathamesh Yuvraj		CSE		

Sr.No	Complete Name	Mob. No.	Branch	Sign. Session-I	Sign. Session-II
41	Nalawade Rutuja Jagannath		CSE	<u>Nalawade</u>	<u>Nalawade</u>
42	Nalawade Sanika Anil	9322766875	CSE	<u>SN</u>	<u>SN</u>
43	Pakhale Omkar Santosh	85305241497	CSE	<u>Pakhale</u>	<u>Pakhale</u>
44	Patil Mrunali Ashok		CSE		
45	Patil Pranjali Sanjay	9423453023	CSE	<u>Pranjali</u>	<u>Patil</u>
46	Patil Saylee Sanjay	9766672699	CSE	<u>Patil</u>	
47	Patil Vaishnavi Ashok	7498409271	CSE	<u>Patil</u>	<u>Patil</u>
48	Patil Mrunal Mahesh	9373501757	CSE	<u>Patil</u>	<u>Patil</u>
49	Patil Pranjali Pradip	8585037156	CSE	<u>Patil</u>	<u>Patil</u>
50	Patil Sakshi Mohan	9172396016	CSE	<u>Patil</u>	<u>Patil</u>
51	Patil Shreya Dadaso	9021102310	CSE	<u>Patil</u>	<u>Patil</u>
52	Patil Suyash Jivan	7066813773	CSE	<u>Patil</u>	<u>Patil</u>
53	Patil Vishal Ramkrishna	9730220101	CSE	<u>Patil</u>	<u>Patil</u>
54	Patole Shrivani Mahesh		CSE	<u>Patole</u>	<u>Patole</u>
55	Pawar Mayur Pratap	9359298530	CSE	<u>Pawar</u>	<u>Pawar</u>
56	Pawar Dhanashri Nitin	9022449491	CSE	<u>Pawar</u>	<u>Pawar</u>
57	Pawar Harshali Madan	9975350496	CSE	<u>Pawar</u>	<u>Pawar</u>
58	Pawar Pratik Shankar	7219415049	CSE	<u>Pawar</u>	<u>Pawar</u>
59	Poojary Varsha Vasantha	9588650699	CSE	<u>Poojary</u>	<u>Poojary</u>
60	Pawar Kajal Krishnat	766600525	CSE	<u>Pawar</u>	<u>Pawar</u>
61	Reke Parth Pradeep		CSE		
62	Salunkhe Rucha Sandesh	8010821614	CSE	<u>Salunkhe</u>	<u>Salunkhe</u>
63	Sarang Trupti Balaji	8855827719	CSE		
64	Shedage Gauri Dhanaji	8550987006	CSE	<u>Shedage</u>	<u>Shedage</u>
65	Shejwal Archana Raju	8485856454	CSE	<u>Shejwal</u>	<u>Shejwal</u>
66	Shete Sakshi Dhananjay	8966452047	CSE	<u>Shete</u>	<u>Shete</u>
67	Shikalgar Juned Kamruddin	8169007031	CSE	<u>Shikalgar</u>	<u>Shikalgar</u>
68	Shinde Sanika Sandeep	9860851711	CSE	<u>Shinde</u>	<u>Shinde</u>
69	Shinde Sanika Sanjay	9356107975	CSE	<u>Shinde</u>	<u>Shinde</u>
70	Shinde Tanmay Balkrishna	9561513921	CSE	<u>T.B.Shinde</u>	<u>T.B.Shinde</u>
71	Shirsat Salonee Pravin	9894710791	CSE	<u>Shirsat</u>	<u>Shirsat</u>
72	Sonawale Sakshi Baburao	7391915503	CSE	<u>Sonawale</u>	<u>Sonawale</u>
73	Shaikh Alfiya Asif		CSE		
74	Tandale Pradnya Mahesh	79666344399	CSE	<u>Tandale</u>	<u>Tandale</u>
75	Vetal Shivanjali Ramrao	8010118088	CSE	<u>Vetal</u>	<u>Vetal</u>
76	Yadav Pratiksha Balasaheb	70281720289	CSE	<u>Yadav</u>	<u>Yadav</u>
*	APhale Himanshu Dombhichan	7588333162	MECH	<u>APhale</u>	<u>APhale</u>



Dr. Ashok Gujar Technical Institute's
Dr. Daulatrao Aher College of Engineering, Karad
Aptitude & Training for TE - All Branches
Date : 05/11/2022 Venue: CR- 18 Mech. Dept.

Summary (Mech.)

Sr. No.	Name of Student	Branch	Date		Total days
			5/11/2022	11/11/2022	
1	Abhishek S Pawar	MECH	0	1	1
2	Balawant A Jadhav	MECH	0	1	1
3	Bobade Mahesh Sadashiv	MECH	0	1	1
4	Dingane Omkar Shivaji	MECH	0	1	1
5	Gavate Shreyas Mahesh	MECH	0	0	0
6	Himanshu Devbhusan A	MECH	1	1	2
7	Jamale Tushar Nathuram	MECH	0	1	1
8	Lohar Vedant Bhaskar	MECH	0	0	0
9	More Pratil Satish	MECH	0	1	1
10	Patil Sangram Maruti	MECH	0	1	1
11	Prathamesh Mukund G	MECH	0	0	0
12	Ratan P Thorat	MECH	0	1	1
13	Sande Sajid Jahangir	MECH	0	0	0
14	Shubham Shivaji Thorat	MECH	0	0	0
15	Patil Saurabh Shankar	MECH	0	0	0
16	Attar Namira Ayub	MECH	0	0	0
17	Kamble Prajka Shantaram	MECH	0	0	0
18	Jagtap Pragati Pratap	MECH	0	0	0
19	Devgan Vaishnavi A	MECH	0	1	1
20	Patel Arshiya Tajuddin	MECH	1	1	2
21	Kaware Kalyani Balaso	MECH	0	0	0
22	Gadave Rutuja Rajendra	MECH	0	1	1
23	Patil Sayali Tukaram	MECH	0	0	0
24	Patel Aavej Vahid	MECH	1	1	2
25	Dhavade Tejas C	MECH	0	1	1
26	Patel Shoyab Altaf	MECH	1	1	2
27	Soheb Jabbar Bagwan	MECH	1	1	2
28	Lad Ruchika Rajendra	MECH	0	1	1
29	Kadam Suhas Suresh	MECH	0	0	0
30	Madane Omkar Mukund	MECH	0	0	0
31	Keluskar Atharav Rajendra	MECH	0	1	1
32	Kamble Aditya Dilip	MECH	0	1	1
33	Kumbhar Avishkar S	MECH	0	1	1
34	Jadhav Romesha Adhikrao	MECH	1	0	1
35	Jadhav Jaydip Ganesh	MECH	0	0	0
36	Kutte Mayuresh M	MECH	0	0	0

37	Patil Indrajeet Satish	MECH	0	0	0
38	Kanade Kaustubh Avinash	MECH	0	1	1
39	Patil Shivraj Sandeep	MECH	0	0	0
40	Sabale Aryan Satyawan	MECH	0	0	0
41	Pawar Ranjeet Satish	MECH	0	0	0
42	Desai Shivam Ashok	MECH	1	1	2
43	Shaikh Umar Samir	MECH	0	0	0
44	Bhingardeve Rushikesh R	MECH	0	0	0
45	Mahadik Aniruddha A	MECH	0	0	0
46	Patil Ganesh Sambhaji	MECH	0	1	1
47	Kokare Vishwajeet S	MECH	0	1	1
48	Sonavane Prathamesh Biju	MECH	0	0	0
49	Velhal Rutvik Sunil	MECH	0	1	1
50	Pol Shivam Rajendra	MECH	0	0	0
51	Sonavale Satyam Mohan	MECH	0	0	0
52	Choudhari Akash A	MECH	0	0	0
53	Nalawade Sagar Sunil	MECH	0	0	0
54	Nalawade Akshay Dinkar	MECH	0	0	0
55	Mane Manthan Vidhyanath	MECH	0	0	0
56	Thakur Darshankumar S	MECH	0	0	0
57	Shaikh Faizal Gaibesab	MECH	0	0	0
58	Dhumal Rohit Mohan	MECH	0	0	0
59	Jadhav Tejas Jaykar	MECH	0	0	0
60	Dubal Dinesh Sudhakar	MECH	0	0	0
61	Bandal Ajinkyadev Arun	MECH	0	0	0
62	Sutar Bhalchandra Prakash	MECH	0	0	0
63	Torane Abhishek Hanmant	MECH	0	0	0
64	Mulik Vinayak Vijay	MECH	0	0	0
65	Nikam Hrishikesh Kuldip	MECH	0	0	0
66	Matekar Amar Yashwant	MECH	0	0	0
67	Shinde Omkar Vilas	MECH	0	0	0
68	Gaikwad Santosh D	MECH	0	0	0
69	Pawar Suraj Shivaji	MECH	0	0	0
70	Sawant Sairaj Suresh	MECH	0	0	0
71	Gurav Ajinkya Ramesh	MECH	0	0	0



Dr. Ashok Gujar Technical Institute's
Dr. Daulatrao Aher College of Engineering, Karad
Aptitude & Training for TE - All Branches

Date : 05/11/2022 Venue: CR- 18 Mech. Dept.

Summary (ENTC.)

Sr. No.	Name of Student	Branch	Date		Total days
			5/11/2022	11/11/2022	
1	BhingardeveVidhya .G	ENTC	0	1	1
2	Dsouza Venissa Prakash	ENTC	1	1	2
3	Jadhav Yashshree Prashant	ENTC	0	0	0
4	Shetty Gautami Avinash	ENTC	0	1	1
5	Patil Shruti Rajaram	ENTC	1	1	2
6	Mane Vaishnavi Jeevan	ENTC	1	1	2
7	Patil Rutuja Dilip	ENTC	0	1	1
8	Patil Satyajit Ashok	ENTC	0	1	1
9	Patil Shivraj Shashikant	ENTC	0	1	1
10	Mane Prakash Jaysing	ENTC	0	1	1
11	Kashid Sanket Maruti	ENTC	0	0	0
12	Chavan Gayatri Laxman	ENTC	0	0	0
13	Patel Afsana Rashid	ENTC	1	1	2
14	Magdum Swapnali Vilas	ENTC	1	1	2
15	Mane Shweta Sunil	ENTC	1	1	2
16	Lade Anamika Dipak	ENTC	0	0	0
17	Patil Aditi Rajendra	ENTC	1	1	2
18	Pawar Pranita Appaso	ENTC	0	1	1
19	Shinde Vaishnavi B	ENTC	0	0	0
20	Lole Rutika Sambhaji	ENTC	0	0	0
21	Patil Gauri Tanaji	ENTC	1	1	2
22	Jadhav Aishwarya Abaso	ENTC	1	1	2
23	Thapa Durva Chandrakant	ENTC	1	1	2
24	Salave Dipti Bhimarao	ENTC	1	1	2
25	Lade Tanvi Sandesh	ENTC	1	1	2
26	Shinde Vaishnavi Vikas	ENTC	1	1	2
27	Kashilkar Shreya Dhananjay	ENTC	1	1	2
28	Todkar Shradha Jitendra	ENTC	0	0	0
29	Chavan Shivani Sayaji	ENTC	0	0	0
30	Pawar Gayatri Suhas	ENTC	0	0	0
31	Jadhav Sakshi Dattaji	ENTC	0	0	0
32	Nikam Pranav Subhash	ENTC	0	0	0
33	Phalle Bhagavant Anil	ENTC	0	1	1
34	Pawar Ganesh Mohan	ENTC	0	0	0
35	Kachare Harshavardhan J.	ENTC	0	1	1
36	Kanase Aditya Ashok	ENTC	0	0	0

37	Mulla Muskan Iqbal	ENTC	0	0	0
38	Sayyad Siddiq Nijam	ENTC	0	0	0
39	Ghutugade Sanket Sambhaji	ENTC	0	0	0
40	Nalawade Rushikesh .R	ENTC	0	0	0
41	Gharage Shivam Sanjay	ENTC	0	0	0
42	Desai Prathamesh Dattatray	ENTC	0	0	0
43	Chavan Swapnali Mahadev	ENTC	0	0	0
44	Kazi Ayan Nasir	ENTC	0	1	1
45	Gurav Dattatray Dnyendev	ENTC	0	1	1



**Dr. Ashok Gujar Technical Institute's
Dr. Daulatrao Aher College of Engineering, Karad
Aptitude & Training for TE - All Branches
Date : 04/11/2022 Venue: CR- 18 Mech. Dept.
Summary (CIVIL.)**

Sr. No.	Name of Student	Branch	Date		Total days
			4/11/2022	12/11/2022	
1	Attar Ajnan Dastagir	CIVIL	0	0	0
2	Babar Akshay Jaysing	CIVIL	0	0	0
3	Baing Aniket Shankar	CIVIL	0	0	0
4	Bamane Sanket Bhaskar	CIVIL	0	0	0
5	Bhagwat Akash Jaywant	CIVIL	0	0	0
6	Dhalewarikar Omkar	CIVIL	1	0	1
7	Bhasme Aishwarya. C	CIVIL	1	1	2
8	Bhat Samruddhi Sagar	CIVIL	1	0	1
9	Bhoi Rohit Anil	CIVIL	0	0	0
10	Bhopate Nilesh Mohan	CIVIL	0	0	0
11	Chalke Abhishek Eknath	CIVIL	0	0	0
12	Channe Shubham Shankar	CIVIL	0	0	0
13	Chavan Abhijit Suresh	CIVIL	0	0	0
14	Chavan Omkar Shivaji	CIVIL	0	0	0
15	Chavan Rutuja Sambhajirao	CIVIL	1	0	1
16	Chavan Sunil Rajaram	CIVIL	1	0	1
17	Desai Suraj Shivaji	CIVIL	0	0	0
18	Desimukhi Saurabh	CIVIL	0	0	0
19	Devlekar Nitraj Nitin	CIVIL	0	0	0
20	Dhulugade Pratik Shankar	CIVIL	0	0	0
21	Dingane Prachi Rajendra	CIVIL	0	0	0
22	Falke Akanksha Ashok	CIVIL	1	1	2
23	Ghadage Prithviraj Sarjerao	CIVIL	1	0	1
24	Gharge Sameer Rajendra	CIVIL	0	0	0
25	Jadhav Dnyanesh	CIVIL	0	0	0
26	Jadhav Dhiraj Shahaji	CIVIL	1	0	1
27	Jadhav Pranit Sunil	CIVIL	0	0	0
28	Jadhav Shraddha Mahesh	CIVIL	1	0	1
29	Jadhav Uday Arun	CIVIL	0	0	0
30	Jadhav Vishwajeet	CIVIL	0	0	0
31	Jagdale Shivendra Rajendra	CIVIL	0	0	0
32	Jagtap Gaurav Dhananjay	CIVIL	0	0	0
33	Janrao Sandhya Kishor	CIVIL	1	1	2
34	Janugade Pranav Anandrao	CIVIL	1	0	1
35	Jujar Tejaswi Suresh	CIVIL	1	1	2
36	Kachare Avaanur	CIVIL	1	0	1
37	Kachhi Aman Ayub	CIVIL	0	0	0

38	Kadam Adiyta Sushilkumar	CIVIL	0	0	0
39	Kadam Akshay Jagannth	CIVIL	0	0	0
40	Kadam Anuja Chandrakant	CIVIL	0	0	0
41	Kajave Atharv Shashikumar	CIVIL	0	0	0
42	Kale Vaishnavi Anil	CIVIL	1	0	1
43	Kharade Aniket Vijay	CIVIL	0	0	0
44	Khedkar Bhushan Abhijit	CIVIL	0	0	0
45	Kolekar Krishna Dhondiba	CIVIL	0	0	0
46	Kulkarni Pratik Pramod	CIVIL	1	0	1
47	Kumbhar Ganesh Pralhad	CIVIL	0	0	0
48	Kurundwad Aman Dilawar	CIVIL	0	0	0
49	Maner Aman Riyaj	CIVIL	0	0	0
50	Maner Sahil Irfan	CIVIL	0	0	0
51	Mohite Shubham R	CIVIL	0	0	0
52	More Abhishek M	CIVIL	0	0	0
53	Mulla Rafiya Najaruddin	CIVIL	1	1	2
54	Nikam Vishwajit Indrajit	CIVIL	0	0	0
55	Patil Ketan Krishant	CIVIL	0	0	0
56	Patil Pruthviraj Rajendra	CIVIL	0	0	0
57	Patil Satish Suresh	CIVIL	0	0	0
58	Patil Shivraj Sanjay	CIVIL	0	0	0
59	Patil Trupti Sunil	CIVIL	0	1	1
60	Patil Varadraj M	CIVIL	0	0	0
61	Pawar Akash Ramchandra	CIVIL	1	0	1
62	Pawar Bhusan Vitthal	CIVIL	1	0	1
63	Pawar Harshal Milind	CIVIL	0	0	0
64	Pawar Kunal Suresh	CIVIL	1	1	2
65	Rasal Shubham Suhas	CIVIL	0	0	0
66	Seneadage Rejaswini Laxmanath	CIVIL	1	1	2
67	Shinde Ashok Kondiba	CIVIL	0	0	0
68	Shinde Nishant Mukund	CIVIL	0	0	0
69	Shinde Rohit Sanjay	CIVIL	0	0	0
70	Sutar Adil Mansur	CIVIL	0	0	0
71	Sutar Asif Salim	CIVIL	0	0	0
72	Sutar Sahil Satish	CIVIL	0	0	0



**Dr. Ashok Gujar Technical Institute's
Dr. Daulatrao Aher College of Engineering, Karad
Aptitude & Training for TE - All Branches
Date : 04/11/2022 Venue: CR- 18 Mech. Dept.
Summary (CSE.)**

Sr. No.	Name of Student	Branch	Date		Total days
			4/11/2022	12/11/2022	
1	Bagwan Kamini	CSE	0	0	0
2	Bagwan Kamini	CSE	0	1	1
3	Bansode Vidya Pravin	CSE	0	0	0
4	Chavan Prashant Yuvraj	CSE	0	1	1
5	Chavan Shubham Sanjay	CSE	0	0	0
6	Chorage Ankita	CSE	0	1	1
7	Chorage Pratik Arjun	CSE	0	1	1
8	Christiyan Shine Jayan	CSE	0	1	1
9	Couto Glenn Gilbert	CSE	1	1	2
10	Chavan Tejaswini Dilip	CSE	1	1	2
11	Desai Rohan Ramesh	CSE	0	0	0
12	Gadale Snehal Krishna	CSE	1	1	2
13	Gawade Komal Kiran	CSE	1	1	2
14	Gurav Anshwarya	CSE	0	0	0
15	Inamdar Diya Ramjan	CSE	1	1	2
16	Inamdar Zaid Salim	CSE	1	1	2
17	Jadhav Snehal Sanjay	CSE	1	1	2
18	Kadam Sakshi Milind	CSE	1	1	2
19	Karaskar Anshika	CSE	1	1	2
20	Randhe Prerona	CSE	0	1	1
21	Karale Aakanksha C	CSE	1	1	2
22	Karande Neha Ganesh	CSE	1	1	2
23	Kate Asmita Yuvraj	CSE	1	1	2
24	Katu Omkar Baban	CSE	0	1	1
25	Kharat Minal Sudam	CSE	0	1	1
26	Khot Shruti Sharad	CSE	1	1	2
27	Kodulkar Omkar Arun	CSE	0	1	1
28	Kumbhar Pratik	CSE	1	1	2
29	Lawand Manasi Mahesh	CSE	1	1	2
30	Lohar Prajakta Prakash	CSE	1	1	2
31	Mahadik Viraj Nitin	CSE	0	1	1
32	Mahajan Nikita	CSE	1	1	2
33	Mane Sanket Shinabhau	CSE	0	1	1
34	Mohite Gaurav Ramdas	CSE	1	1	2
35	Moolya Nidhish Narayan	CSE	1	1	2
36	Mujawar Rizwan Abid	CSE	1	1	2
37	Mujawar Saad Najir	CSE	0	0	0

38	Wrujawa Jayama	CSE	1	1	2
39	Mulla Suhan Jameer	CSE	0	1	1
40	Wagnar Ratnamesh	CSE	0	0	0
41	Narawade Kutuja	CSE	1	1	2
42	Nalawade Sanika Anil	CSE	1	1	2
43	Pakhale Omkar Santosh	CSE	0	1	1
44	Patil Mrunali Ashok	CSE	0	0	0
45	Patil Pranjali Sanjay	CSE	1	1	2
46	Patil Saylee Sanjay	CSE	1	1	2
47	Patil Vaishnavi Ashok	CSE	1	1	2
48	Patil Mrunal Mahesh	CSE	1	1	2
49	Patil Pranjali Pradip	CSE	1	1	2
50	Patil Sakshi Mohan	CSE	1	1	2
51	Patil Shreya Dadaso	CSE	1	1	2
52	Patil Suyash Jivan	CSE	1	1	2
53	Patil Vishal Ramkrishna	CSE	0	1	1
54	Patole Shravani Mahesh	CSE	1	1	2
55	Pawar Mayur Pratap	CSE	0	1	1
56	Pawar Dhanashri Nitin	CSE	1	1	2
57	Pawar Harshali Madan	CSE	1	1	2
58	Pawar Pratik Shankar	CSE	0	1	1
59	Poojary Vansha	CSE	1	1	2
60	Pawar Kajal Krishnat	CSE	1	1	2
61	Reke Parth Pradeep	CSE	0	0	0
62	Sarankhe Kuchra	CSE	1	1	2
63	Sarang Trupti Balaji	CSE	1	1	2
64	Shedage Gauri Dhanaji	CSE	1	1	2
65	Shejwal Archana Raju	CSE	1	1	2
66	Shete Sakshi Dhananjay	CSE	0	1	1
67	Shinkargar Suned	CSE	0	1	1
68	Shinde Sanika Sandeep	CSE	1	1	2
69	Shinde Sanika Sanjay	CSE	1	1	2
70	Shinde Ranmay	CSE	0	1	1
71	Shirsat Salonee Pravin	CSE	1	1	2
72	Shirawate Sakshi	CSE	1	1	2
73	Shaikh Alfiya Asif	CSE	1	0	1
74	Shankar Ratanya	CSE	1	1	2
75	Vetal Shivanjali Ramrao	CSE	1	1	2
76	Vatav Ratikshna	CSE	1	1	2



Dr. Ashok Gujar Technical Institute's

**Dr. Daulatrao Aher College of Engineering, Karad
Aptitude & Training for TE - All Branches**

Date : 04-05/11/2022 to 11-12/11/2022 Venue: Auditorium

Branchwise Training Attendance

Sr. No.	Branch	Dates			
		4/11/2022	5/11/2022	11/11/2022	12/11/2022
1	MECH		7	25	
2	ENTC		14	25	
3	CIVIL	20			8
4	CSE	48			66

	Total	68	21	50	74
--	--------------	----	----	----	----



Mr. Rohit Patil



Shot on Y15
Vivo AI camera

2020.03.05 11:42



G. K. Gujar Memorial Charitable Trust's
Dr. Ashok Gujar Technical Institute's
Dr. Daulatrao Aher College of Engineering, Karad
Accredited by NAAC with B+ & ISO 9001-2008 Certified Institute
Training & Placement Cell

AGTI's /DACOE/ TPO/2021-2022/06

Date: 17/11/2022

Notice

All the students shortlisted for TCS - NQT 2022 are hereby informed to note that "Alumni Interaction with Present Students" by Ms. Jakiya Mull BE CSE , TCS, System Engineer, Pune is arranged on 18/11/2022 at 10:00 am at Conference Room.

All the shortlisted students for TCS should attend the session, as Interview tricks and techniques will be shared during the session.

Faculty Coordinator : Ms A.B. Shelar Madam (MECH. DEPT.)

DACOE
Striving for Excellence

Mr. P. D. Bansode
Training & Placement Officer

Dr. Ashok Gujar Technical Institute's
 Dr. Daulatrao Aher College of Engineering Karad
 Topic- Alumni Interaction with Present Students
 Name - Ms. Jakiya Mulla, Wipro Technologys

Date: 18/11/2022 at 10:00 am to 11:00 am Venue: Auditorium

Sr. No	Name of the Students	Branch	Sign.
1	Jang Ankita Tanaji	CSE	Jang
2	Barkade Sakshi Anil	CSE	Barkade
3	Kevala Pallavi Randa	ENTC	Kevala
4	Panwal Pranjali Bajirao	CSE	Panwal
5	Patwekar Aalisha Ilahi	CSE	Patwekar
6	Magangiri Jyoti Sadashiv	Mech	Magangiri
7	Patil Shreya Rajendra	CSE	Patil
8	Patil Sanchita Ramchandra	mech	Patil
9	Suryawanshi Sanjana Vijay	Civil	Suryawanshi
10	Patil Vaishnavi Bharuddas	ENTC	Patil
11	Sawant Aditi Akshay	CSE	Sawant
12	Survase Rutuja Anu	CSE	Survase
13	Dhanashree Sambhosh Bhoite	CSE	Dhanashree
14	Aditi Anil Ghodaje	ENTC	Ghodaje
15	Shewale Rachana suryakant	CSE	Shewale
16	Gholap Anjali Ramesh	Entc	Gholap
17	Vaishnavi Ramchandra Chavan	Entc	Vaishnavi
18	Padri Anshuviya Faamanali	CSE	Padri
19	Mulla Simran Yusuf	mech	Mulla
20	Dubal Anjali Jaywant	ENTC	Dubal
21	Ratil Tanuja Rajendra	CSE	Ratil
22	Kumbhar Sakshi Vishwan	Mech	Kumbhar
23	Kurade Tejaswini Sanjiv	Civil	Kurade
24	Mane Rajvardini Pradip	ENTC	Mane
25	Kadam Apurva Sandip	Mech	Kadam
26	Nangare Utkarsha Uday	CSE	Nangare
27	Naigade Anati Bharat	CSE	Naigade
28	Thorat Vaishnavi Sachin	CSE	Thorat
29	Thorat Sanika Prakash	E&TC	Thorat
30	Gavate Sakshi Mahesh	CSE	Gavate
31	Kamble Vaishnavi Vikas	CSE	V.V. Kamble
32	Gehare Tanhavi Vilas	CSE	Gehare
33	Inamdar Anshu Mukhtar	CSE	Anshu
34	Kumbhar Vaishnavi Pramod	E&TC	Vaishnavi
35	Chavan Vasudha Krishnat	Civil	V.K. Chavan
36	Dange Sanika Bhimrao	CSE	Dange
37	Mujawar Afrin Farukh	CSE	Mujawar

Sr. No	Name of the Students	Branch	Sign.
38	Shinde Tejaswri Nivas	Entc	Tejaswri
39	Dange Aditi Shrikant	Mech	Adange
40	More Vishakha Satish	E&TC	More
41	Patil Sanika Sanjay	E&TC	Patil
42	Sakshi Almazam futankar	CSE	Sakshi futankar
43	Aditi Shrikant Kalhurgji	CSE	Aditi
44	Sanika Rahul Pawar	CSE	Sanika
45	Aga Abrar Mustafa	mech	Aga
46	Topale Amit Laxman	E&TC	Amit
47	Amkar Manasa Jadhav	mech	Amkar
48	Patil Amkar Jaykar	Mech	Patil
49	Mulla Manasa Nazamali	E&TC	Mulla
50	Shinde Gurusprasad Ramesh	CSE	Shinde
51	Govard Harshwardhan Bhausaheb	Mech	Govard H.B.
52	Kale Aniket Sanjay	E&TC	A.S. KALE
53	Pavan Susheela Gaitkward	E&TC	Pavan
54	Dekar Hemant Anil	CSE	Hemant Dekar
55	Bade Rahul Ashok	CSE	Rahade
56	Abadar Swapnil Krishna	CSE	Abadar
57	Kumbhar Pratik Tanaji	E&TC	Pratik
58	Kadam Prathamesh Manoj	CSE	Prathamesh
59	Vyankatesh Vijendra Vedpatil	CSE	Vyankatesh
60	Kumbhar Rohan Rajaram	CSE	Rohan
61	Mohite Aditya Mahesh	Civil	Aditya
62	Ayush Sunil Mane	CSE	Ayush
63	Avadhut Papurao Yadav	CSE	Avadhut
64	Sangram Jalindar Pawar	CSE	S.J.P
65	Pawar Ashish Shivaji	CSE	Ashish
66	Katke Ajesh Madhukar	Mech	Katke
67	Harsh Ajit Shinde	Mech	Harsh
68	Sanket Manikasa Tujar	CSE	Sanket
69	Prathamesh Mansing Nikam	CSE	Prathamesh
70	Chetan Dhanaji Kamble	CSE	Chetan
71	Amkar Mohan Navadkar	E&TC	Amkar
72	Siddharth Prakash Jagadik	Civil	Siddharth
73	Imran Babasa Nikhat	CSE	Imran
74	Vivek Sukhadev Kumbhar	E&T.C	Vivek
75	Sumit Vijaykumar Adake	Mech	Sumit
76	Karthik Vinod Acharya	Mech	Karthik
77	Aadhiraaj Sunil Papaskar	Civil	Aadhiraaj
78	Rutvik Sunil Velhal	Mech	Rutvik
79	Akash Mohan Bhuladai	mech	Akash

Dr. Ashok Gujar Technical Institute's
 Dr. Daulatrao Aher College of Engineering Karad
 Topic- Alumni Interaction with Present Students
 Name - Ms. Jakiya Mulla, Wipro Technologys

Date: 18/11/2022 at 10:00 am to 11:00 am Venue: Auditorium

Sr. No	Name of the Students	Branch	Sign.
80	Vishwajit Dattatray Jagtap	Mech	V Jagtap
81	Durgesh Sanjay Bhusari	Mech	D.S.Bhusari
82	Omkar Shivaji Dingane	Mech	O.D.
83	Patil Sangram maruti	mech	Patil
84	More Pratik Satish	mech	More
85	Gosavi Prathamsh mukund	Mech	Gosavi
86	Kumbhar Avishkar Santosh	Mech	AKS
87	Desai Shivam Ashok	Mech	Desai
88	Chavan Nilhil Manohar	Mech	Chavan
89	Chavan Shubham Krishnat	CSE	Chavan
90	Veer Harsh Virendra	EITC	Veer
91	Ayan Navir Kazi	EITC	Ayan
92	Phalle Bhagwant Anil	EITC	Phalle
93	Sanket Sambhaji Chaturvedi	EITC	Sanket
94	Aditya Ashok Kanate	EITC	Aditya
95	Aarav Vahid Patel	Mech	Aarav
96	Bagwan Sahib Tabban	mech	S.T. Bagwan
97	Madane Omkar Mukund	mech	Madane
98	Patel Shoyab Altaf	mech	Patel
99	Dhavade Tejas Chandrakant	mech	Dhavade
100	Crusade Shivan Gussak	EITC	Crusade
101	Shoukh Tafan Jamir	mech	Shoukh
102			
103			
104			
105			
106			
107			
108			
109			
110			
111			
112			
113			
114			
115			
116			



Jakiya Mull



G. K. Gujar Memorial Charitable Trust's
Dr. Ashok Gujar Technical Institute's
Dr. Daulatrao Aher College of Engineering, Karad
Accredited by NAAC with B+ & ISO 9001-2008 Certified Institute
Training & Placement Cell

AGTI's /DACOE/ TPO/2021-2022/06

Date: 09/12/2022

Notice

All the students shortlisted for TCS - NQT 2022 are hereby informed to note that "**Alumni Interaction with Present Students**" by Mr. Avdhut Borade BE MECH , TCS, System Engineer, Pune is arranged on 10/12/2022 at 10:00 am at Conference Room.

All the shortlisted students for TCS should attend the session, as Interview tricks and techniques will be shared during the session.

Faculty Coordinator : Ms A.B. Shelar Madam (MECH. DEPT.)

Mr. P. D. Bansode
Training & Placement Officer



Dr. Ashok Gujar Technical Institute's
Dr. Daulatrao Aher College of Engineering, Karad
Training & Placement Cell

Alumni Interaction with Present Students
by Mr. Avadhut Borade, Infosys Placed 2022

Date : 10/12/2022 Venue: CR

Time: 11:00 am to 12: 30 pm

Sr.No	Complete Name	Class & Branch	Sign.
1	Rutuja Tukaram Patil	S.Y. EITC	Patil
2	Patil Yogita Avinash.	SY E&TC	Patil
3	Jadhav Vaishnavi S	SY E&TC	Jadhav
4	Pawar Aishwarya Prakash	B.Tech CSE	Pawar
5	Yadav Samiksha Ramesh	B.Tech CSE	Yadav
6	More priya vikas	B.Tech CSE	More
7	chavan mayuri vikas	B.Tech CSE	Chavan
8	Bendre Tsha Sandip	B.Tech CSE	Bendre
9	Sawant Ekta Ravindra	B.Tech CSE	Sawant
10	Aurav Bhagyashree Shashikant	B.Tech CSE	Aurav
11	Muskan Tayyabali Mulla	B.Tech CSE	Mulla
12	Wangade Kartiki Sanjay	B.Tech CSE	Wangade
13	Khandagale Phansmi Chhagan	B.Tech CSE	Phansmi
14	Yadav Mayuri vikas	B.Tech CSE	Yadav
15	Kadam Kajal Chandrakant	B.Tech CSE	Kadam
16	Kehrisagar Vishnvi Mechindranath	B.Tech CSE	Kehrisagar
17	Patil Snehal Ramesh	B.Tech CSE	Patil
18	Kesare Rutuja Sanjay	B.Tech CSE	Kesare
19	Vaske Aanya Atul	B.Tech CSE	Vaske
20	Yadav Nikita Anil	B.Tech CSE	Yadav
21	Jadhav Pooja Avinash	B.Tech CSE	Jadhav
22	Mayuri Sanjay Desai	B.Tech CSE	Mayuri
23	Manali Ravikant Jadhav	B.Tech CSE	Manali
24	Mrunali Nanaso Shinde	B.Tech CSE	Shinde
25	Pallavi Kundlik Karje	B.Tech CSE	Pallavi
26	Dipti Suryakant Patil	B.Tech CSE	Dipti
27	Pratiksha Kumalakar Kumbhar	B.Tech CSE	Pratiksha
28	Tarupti Suryakant Patil	B.Tech CSE	Tarupti
29	Pratiksha Sanjay Patil	B.Tech CSE	Pratiksha
30	Shelar Prathmesh Balaso	B.Tech CSE	Shelar
31	Bhosale Prasad Sunil	B.Tech CSE	Bhosale
32	Nikam Shubhankar Sureb	B.Tech CSE	Nikam
33	Karan Abasaheb More	B.Tech CSE	Karan
34	Vishvajit Dipak Suryawanshi	B.Tech CSE	Vishvajit
35	Siddhant Dipak Horne	B.Tech CSE	Siddhant

Sr.No	Complete Name	Class & Branch	Sign.
36	David Shabbir Mulla	B.Tech CSE	D. Simulla
37	Kadam Shirya Sajaji	B.Tech CSE	Kadam
38	Jadhav Prayal Anirash	B.Tech CSE	(Prayal)
39	Pragati Mahesh Bili	B.Tech CSE	Pragati
40	Rutuja Anil Koli	B.Tech CSE	Rutuja
41	Ami Dipakkumar Mansuraniya	B.Tech CSE	Ami
42	Shreya Sharad Jadhav	B.Tech CSE	Shreya
43	Anuja Rajendra Gaikwad	B.Tech CSE	Anuja
44			
45			
46			
47			
48			
49			
50			
51			
52			
53			
54			
55			
56			
57			
58			
59			
60			
61			
62			
63			
64			
65			
66			
67			
68			
69			
70			
71			
72			
73			
74			
75			
76			
77			
78			



GPS Map Camera

Karad, Maharashtra, India

858W+745, Karad, Maharashtra

415124, India

Lat 17.315586°

Long 74.195502°

10/12/22 12:11 PM GMT +05:30





G.K. Gujar Memorial Charitable Trust's
Dr. Ashok Gujar Technical Institute's,
Dr. Daulatrao Aher College of Engineering, Karad.
Vidyanagar Ext. Banawadi, Tal. Karad 415124, Dist. Satara, Maharashtra INDIA
BASIC SCIENCES AND HUMANITIES DEPARTMENT

17

10

NOTICE

Date-22/12/2022

Soft Skills Training

All F.Y.B.Tech. Student are hereby informed that "Soft Skills Training" is arranged on Monday, 26th to Friday 30th Dec.2022 in Auditorium Hall. Attendance is mandatory to all and attendance is considered for academic record.

Time: 10.00 am to 5.00 pm

S. Namsene
Programme Coordinator

Bhujar
H.O.D

[Signature]
Principal

Div - D - Digvijay suinde — Dsu
23/12/22
Div - C — P I kinika — BT
Div B - S.B. Aaran JS
Div A - A.B. Shela — Ater



Sr. No.
1
2
3
4
5
6
7
8
9
10
11
12
13
14
15
16
17
18
19
20
21
22
23
24
25
26
27
28
29
30



G.K. Gujar Memorial Charitable Trust's
Dr. Ashok Gujar Technical Institute's,
Dr. Daulatrao Aher College of Engineering, Karad.
Vidyanagar Ext. Banawadi, Tal. Karad 415124, Dist. Satara, Maharashtra INDIA

Department of Basic Sciences & Humanities

Soft Skills Training

Academic Year 2022-23

Attendance of F. Y. B. Tech

Date: 27/12/2022

Sr. No.	Name of Student	Branch	11.00am to 1.00pm	2.00pm to 5.00pm
1	Chavan Vasudha Krishnat	Civil	V.K.Chavan	V.K.Chavan
2	Kumbhar Vaishnavi Pramod	ESTC	Vaishnavi	Vaishnavi
3	Patwekar Aalisha Ilahi	CSE	Apaturkar	Apaturkar
4	Dange Sanika Bhimrao	CSE	Sringel	Sringel
5	Afrin Fazukh Mujawar	CSE	Afrin	Afrin
6	Kamble Vaishnavi Vikas	CSE	V.V.Kamble	V.V.Kamble
7	Gaikwad Vaishnavi Dipak	E&TC	V.V.Kamble	V.V.Kamble
8	Bhosale Swapnil Shataji	E&TC	Bhosale	Bhosale
9	Shinde Harsh Ajit	Mech	Harsh	Harsh
10	Prathamesh Umara Bhojrao	Civil	Prathamesh	Prathamesh
11	Abbas Mustafa Aga	Mech	Abbas	Abbas
12	Shainesh Kailas Palange	E&TC	Shainesh	Shainesh
13	Mangrajaji Jaji Satehji	Mech	Mangrajaji	Mangrajaji
14	Kafre Akash Shivaji	E&TC	Kafre	Kafre
15	Patil Sanika Sanjay	E&TC	Patil	Patil
16	Shewale Rachana Suryakant	CSE	Shewale	Shewale
17	Gavate Sakshi Mahesh	CSE	Gavate	Gavate
18	Thorat Vaishnavi Sachin	CSE	Thorat	Thorat
19	Shinde Shroddha Prakash	ESTC	Shinde	Shinde
20	Omumal Pratiksha Pramod	CSE	Omumal	Omumal
21	Suryawonshi Sanjona Vijay	Civil	Suryawonshi	Suryawonshi
22	Sunvase Rutuja Arun	CSE	Sunvase	Sunvase
23	Hadhiraj Suniti Paraskar	Civil	Hadhiraj	Hadhiraj
24	Abadar Swapnil Krishnat	CSE	Abadar	Abadar
25	Maaz Nasirali Mulla	E&TC	Maaz	Maaz
26	Suzan Aijam Shaikh	CSE	Shaikh	Shaikh
27	Vaishnavi Lalaso Chavan	CSE	Chavan	Chavan
28	Thorat Sakshi Ananda	E&TC	Thorat	Thorat
29	Vishwakarma B.G.	Mech	Vishwakarma	Vishwakarma
30	Kavyanjali V. Chavan	Mech	Kavyanjali	Kavyanjali
31	Gharal Anantkumar Hanmant	CSE	Gharal	Gharal
32	Sanket Manikrao Jujar	CSE	Sanket	Sanket
33	Aashish Rajendra Snete	CSE	Aashish	Aashish



G.K. Gujar Memorial Charitable Trust's
Dr. Ashok Gujar Technical Institute's,
Dr. Daulatrao Aher College of Engineering, Karad.
Vidyanagar Ext. Banawadi, Tal. Karad 415124, Dist. Satara, Maharashtra INDIA

Department of Basic Sciences & Humanities

Sr. No.	Name of Student	Branch	11.00am to 1.00pm	2.00pm to 5.00pm
34	Siddharth Prakash Mahadik	Civil	S. Mahadik	S. Mahadik
35	Devkar Hemant Anil	CSE	H. Devkar	H. Devkar
36	Jayed Chand Patel	CSE	J. Patel	J. Patel
37	Garud Harshwardhan Bhausaheb	Mech	G. Bhausaheb	G. Bhausaheb
38	Athani Krishnarao Kshirsagar	CSE	A. Kshirsagar	A. Kshirsagar
39	Shambhuj Dadasa Chavan	CSE	S. Chavan	S. Chavan
40	Omkar Rajkumar Patil	CSE	O. Patil	O. Patil
41	Abhi Kulkarni	Civil	A. Kulkarni	A. Kulkarni
42	Vaibhav Ravindra Bagal	CSE	V. Bagal	V. Bagal
43	Akshay Ramkundra Najan	CSE	A. Najan	A. Najan
44	Tohif Yaqub Shaikh	E&TC	T. Shaikh	T. Shaikh
45	Kumbhar Rohan baban	E&TC	R. Kumbhar	R. Kumbhar
46	Kumbhar Vivek Sukhadev	E&TC	V. Kumbhar	V. Kumbhar
47	Kate Vivek Dadasaheb	E&TC	K. Kate	K. Kate
48	Jangid Nishant madanlal	E&TC	N. Jangid	N. Jangid
49	Lokhonde Rushikesh ghans	E&TC	L. Lokhonde	L. Lokhonde
50	Yadav Hrudait Bapurao	CSE	H. Yadav	H. Yadav
51	Rohan Sushilkumar Nimbalkar	CSE	R. Nimbalkar	R. Nimbalkar
52	Patil Vaishnavi sandip	E&TC	V. Patil	V. Patil
53	Patil Vaishnavi Bhanudas	E&TC	V. Patil	V. Patil
54	Garud Amruta Jitendra	Mech	G. Garud	G. Garud
55	Khatole Pranali Dattatray	E&TC	P. Khatole	P. Khatole
56	Jadhav Aishwarya Namdev	E&TC	A. Jadhav	A. Jadhav
57	Dadas Anishya Farmanali	CSE	A. Dadas	A. Dadas
58	Batkar Samruddhi Prakash	CSE	B. Batkar	B. Batkar
59	Patil Ananya Ashok	CSE	A. Patil	A. Patil
60	Mulani Sabiya	CSE	M. Mulani	M. Mulani
61	Kolone Jitesh Madhukar	Mech	J. Kolone	J. Kolone
62	Kumbhar Sakshu Vishwas	Mech	K. Kumbhar	K. Kumbhar
63	Nikita Rajesh Tate	E&TC	N. Tate	N. Tate
64	Sawant Aditi Akshay	CSE	S. Sawant	S. Sawant
65	Salunke Vishakha Dattatray	CSE	V. Salunke	V. Salunke
66	Acharya Parth Vinod	Mech	P. Acharya	P. Acharya
67	Mane Rajnandini Pradip	E&TC	M. Mane	M. Mane
68	Navadkar Omkar Mohan	E&TC	O. Navadkar	O. Navadkar
69	Salunke Kaitik Jitendra	E&TC	K. Salunke	K. Salunke
70	Thoset Sanika Prakash	E&TC	T. Thoset	T. Thoset
71	Jarag Ankita Tanaji	CSE	J. Jarag	J. Jarag
72	More Vishakha Satish	E&TC	M. More	M. More



G.K. Gujar Memorial Charitable Trust's
Dr. Ashok Gujar Technical Institute's,
Dr. Daulatrao Aher College of Engineering, Karad.
Vidyanagar Ext. Banawadi, Tal. Karad 415124, Dist. Satara, Maharashtra INDIA

Department of Basic Sciences & Humanities

Sr. No.	Name of Student	Branch	11.00am to 1.00pm	2.00pm to 5.00pm
73	Jamale, Kiran, Gorakh	E&TC	Kajamale	Kajamale
74	Patil Vedita Adhikar	E&TC	Vedita	Vedita
75	Gholap Anjali Ramesh	E & Tc	ARGholap	ARGholap
76	Ghadage Aditi Anil	E & TC	Ghadage	Ghadage
77	Borkade Sakshi Anil	CSE	Borkade.S.A	Borkade.S.P
78	mahamuni vaidehi Milind	CSE	Mahamuni	Mahamuni
79	Jadhav Ankar Lalasa	E&TC	Jadhav	Jadhav
80	Jafan Jami Shaikh	Mech	Shaikh	Shaikh
81	Sankalp Sanjay Karande	E&TC	Sankalp	Sankalp
82	Sahil Santosh Mane	Civil	Sahil	Sahil
83	Salunkhe Swarup Sanjay	Mech	Salunkhe	Salunkhe
84	Tate Prem Vasant	CSE	Tate	Tate
85	chavan Nikhil Manohar	Mech	Chavan	Chavan
86	Abhitekar Arun Mali	CSE	Abhitekar	Abhitekar
87	shivam Desai	Mech	Shivam	Shivam
88	Pranali Patil	CSE	Pranali	Pranali
89	Tawar Prasad	Mech	Tawar	Tawar
90	Jadhav Shrawani Suhag	CSE	Jadhav	Jadhav
91	Mohite Sakshi Devidas	mech	Mohite	Mohite
92	Pawar Maithili Dattatray	ENTC	Pawar	Pawar
93	Rohil Tanuja Rajendra	CSE	Rohil	Rohil
94	Deshmukh Siddhi Vasinth	ENTC	Siddhi	Siddhi
95	Kate Aniket Sanjay	ENTC	A.S. Kate	A.S. Kate
96	Wagh Bhatik Dhanaji	ENTC	P.D. Wagh	P.D. Wagh
97	Morse Aadash manik	E&TC	A. Morse	A. Morse
98	Adake Gurnit V.	Mech	Adake	Adake
99	Sangam Jalindar pawar	CSE	S.J.P	S.J.P
100	Jingavale Arya Anandrao	Civil	Jingavale	Jingavale
101	Patil Priti Anil	Civil	Patil	Patil
102	Nangare Utkarsha Uday	CSE	Nangare	Nangare
103	kevale pallavi Bandu	E&TC	Kevale	Kevale
104	Shinde Aditi Sunil	ENTC	Shinde	Shinde
105	Kadam Apurva Sandip	Mech	Kadam	Kadam
106	Chore Janhavi Vilas	CSE	Chore	Chore
107	shinde Sonika Anil	CSE	Shinde	Shinde
108	Nalgade Arati Bharat	CSE	Nalgade	Nalgade
109	Mane shweta shankar.	E&TC	Mane	Mane
110	Thorat Shritee Sayaji	CSE	Thorat	Thorat
111	Onkar Suryakant Jangam	E&TC	Jangam	Jangam



G.K. Gujar Memorial Charitable Trust's
Dr. Ashok Gujar Technical Institute's,
Dr. Daulatrao Aher College of Engineering, Karad.
Vidyanagar Ext. Banawadi, Tal. Karad 415124, Dist. Satara, Maharashtra INDIA

Department of Basic Sciences & Humanities

Sr. No.	Name of Student	Branch	11.00am to 1.00pm	2.00pm to 5.00pm
112	Indrajeet Rajesh Pakhare.	C.S.E.	gachare	gachare
113	Shamir Navem Mujawar	Mech	Smujawar	Smujawar
114	Vyankatesh Rajendra Vedpathak	C.S.E.	Rudh	Rudh
115	Sanket Sandip Suryawanshi	E&TC	Sanket	Sanket
116	Kadam Tejus Suresh	E&TC	Suresh	Suresh
117	Jadhav Shrinjay Gajanan	E&TC	Sudhar	Sudhar
118	Godse Sakshi Appasabeb	E&TC	Sakshi	Sakshi
119	Jadhav Vedika Sharad	CSE	Sudhar	Sudhar
120	Bhoik Dhanashree Santosh	CSE	Bhoik	Bhoik
121	Pawar Sanika Rahul	CSE	Spar	Spar
122	Veer Harsh Virendra	E&TC	Harsh	Harsh
123	Vishnavi Ramchandra Chavan	E&TC	Chavan	Chavan
124	Yashnavi Satish Yelvale	E&TC	Yelvale	Yelvale
125	More Prati Hanmant	CSE	Prati	Prati
126	Chavan Shubham Krishnaat	CSE	Shubham	Shubham
127	Kumbhar Ajinkya Kiran	CSE	Kumbhar	Kumbhar
128	Shikalgar Aajay Samir	E&TC	Shikalgar	Shikalgar
129	Surve Prathmesh Shivnath	CSE	Surve	Surve
130	Patil Ashan Sambhaji	CSE	Patil	Patil
131	Prathamesh Mansing Nikam	CSE	Prathamesh	Prathamesh
132	Vishakha D. Vanduskar	Mech	Vanduskar	Vanduskar
133	Inamdar Asiya	CSE	Inamdar	Inamdar
134	Patil Sanchita	Mech	Patil	Patil
135	Yadav Ritesh Sunil	Mech	Yadav	Yadav
136	Tarate Indrajit Daulatrao	E&TC	Tarate	Tarate
137				
138				
139				
140				
141				
142				
143				
144				
145				
146				
147				
148				
149				
150				



G.K. Gujar Memorial Charitable Trust's
Dr. Ashok Gujar Technical Institute's,
Dr. Daulatrao Aher College of Engineering, Karad.
Vidyanagar Ext. Banawadi, Tal. Karad 415124, Dist. Satara, Maharashtra INDIA

Department of Basic Sciences & Humanities

Sr. No.	Name of Student	Branch	11.00am to 1.00pm	2.00pm to 5.00pm
151	Bulkam Sanika Ganihar	E&TC	Bulkam	Sanika
152	Mulla Simran Yusuf	Mech	Simran	Simran
153	Shinde Tejasri Nivas	Entc	Tejasri	Tejasri
154	Pavan sushant Gaikwad	ENTC	Gaikwad	Gaikwad
155	chavan sahil shankar	mech	Shavan	Shavan
156	Pathan Sajid Zakirhusen	ENTC	Pathan	Pathan
157	Nodati Imran Babasa	CSE	Nodati	Nodati
158	Tadake Prachi Balasaheb	ENTC	Tadake	Tadake
159	Kalburgi Aditi Shrikant	CSE	Kalburgi	Kalburgi
160	Patil Anpita Suresh	ENTC	Patil	Patil
161	Anjali Jaywant Dubal	E&TC	Dubal	Dubal
162	Arati Shrikant Dange	Mech	Arati	Arati
163	Pranit Tanaji Kumbhar	E&TC	Pranit	Pranit
164	Rohan Rajaram Kumbhar	CSE	Rohan	Rohan
165	Prathamesh Nikam	CSE	Prathamesh	Prathamesh
166	Ayash sunil Mane	CSE	Ayash	Ayash
167	Rahul Ashok Bade	CSE	Rahul	Rahul
168	Alitya Siddhant Jaganant	E&TC	Alitya	Alitya
169	Ganesh mohan Sabale	E&TC	Ganesh	Ganesh
170	shrawan Vinayak Gursale	E&TC	Shrawan	Shrawan
171	Topale Amit laxman	E&TC	Topale	Topale
172	shirsat sahas suresh	Mech	Shirsat	Shirsat
173	Patil Vijay Popat	CSE	Patil	Patil
174	Surve Rushikesh Sambhaji	E&TC	Surve	Surve
175	Pawar Ashish shivaji	CSE	Pawar	Pawar
176	Chetan Dhanaji Kamble	CSE	Chetan	Chetan
177	Patil shreya Rajendra	CSE	Patil	Patil
178				
179				
180				
181				
182				
183				
184				
185				
186				
187				
188				
189				



G.K. Gujar Memorial Charitable Trust's
Dr. Ashok Gujar Technical Institute's,
Dr. Daulatrao Aher College of Engineering, Karad.
Vidyanagar Ext. Banawadi, Tal. Karad 415124, Dist. Satara, Maharashtra INDIA

Department of Basic Sciences & Humanities

Sr. No.	Name of Student	Branch	10.00am to 12.00pm	1.00pm to 5.00pm
190				
191				
192				
193				
194				
195				
196				
197				
198				
199				
200				

[Handwritten signature]
Programme Coordinator

HOD

[Faint handwritten notes and signatures]

[Handwritten mark]



G.K. Gujar Memorial Charitable Trust's
Dr. Ashok Gujar Technical Institute's,
Dr. Daulatrao Aher College of Engineering, Karad.
Vidyanagar Ext. Banawadi, Tal. Karad 415124, Dist. Satara, Maharashtra INDIA

Department of Basic Sciences & Humanities

Soft Skills Training

Academic Year 2022-23

Attendance of F. Y. B. Tech

Date: 26/12/2022

Sr. No.	Name of Student	Branch	10.00am to 12.00pm	1.00pm to 5.00pm	Sign.
1	Asiya Inamdot	C.S.E	Asiya	Asiya	
2	Kumbhar Sakshi	Mech	Kumbhar	Kumbhar	
3	Gholap Anjali	Entc	AR Gholap	AR Gholap	
4	Karande Komal	Entc	Karande	Karande	
5	Addhiraj PapasKar	Civil	Addhiraj	Addhiraj	
6	Imran Naqat	C.S.E	Naqat	Naqat	
7	Ajay shikalgar	E & TC	Ajay shikalgar	Ajay shikalgar	
8	Karande Sankalp	E & TC	Karande	Karande	
9	Sawant Aditya	Entc	Sawant	Sawant	
10	shirsat suhas	mech	shirsat	shirsat	
11	onkars Naik	E & TC	Onkars	Onkars	
12	Aniket Kaire	E & TC	A.S. Kaire	A.S. Kaire	
13	Vyankatesh Vedputrak	C.S.E.	Vyankatesh	Vyankatesh	
14	Jindrajit Patkar	C.S.E	Jindrajit	Jindrajit	
15	Vivek Kete	ERTC	Vivek	Vivek	
16	Tohirf Shaikh	E & TC	Tohirf	Tohirf	
17	Kalpe akash	ERTC	Kalpe	Kalpe	
18	Dewar Hemant	C.S.E	H.A Dewar	H.A Dewar	
19	Abadar Swapnil	C.S.E	Abadar	Abadar	
20	Kumbhar Vivek	E & T.C	Kumbhar	Kumbhar	
21	Sakunthe Kastik	E & T.C	Sakunthe	Sakunthe	
22	Bagal Vaibhav	C.S.E	Bagal	Bagal	
23	Mane Rajnandini	E & TC	Mane	Mane	
24	Mane Sahil	Civil	Mane	Mane	
25	chayan sahil S.	mech	Chayan	Chayan	
26	Grand Hanhwardhan	Mech	Grand	Grand	
27	Bade Raheel A.	C.S.E	Bade	Bade	
28	Patil vishnvi Bharud	E & T.C	Patil	Patil	
29	Pawar Maithili Dattatray	Entc	Pawar	Pawar	
30	Shinde Aditi Sunil	Entc	Shinde	Shinde	
31	Chhore Jankar vilas	C.S.E	Chhore	Chhore	
32	Bhaite Dhanashreed.	C.S.E.	Bhaite	Bhaite	
33	Patil shreyya Rajendra	C.S.E	Patil	Patil	



G.K. Gujar Memorial Charitable Trust's
Dr. Ashok Gujar Technical Institute's,
Dr. Daulatrao Aher College of Engineering, Karad.
Vidyanagar Ext. Banawadi, Tal. Karad 415124, Dist. Satara, Maharashtra INDIA

Department of Basic Sciences & Humanities

Sr. No.	Name of Student	Branch	10.00am to 12.00pm	1.00pm to 5.00pm	Sign.
34	Shinde Sonika Anil	CSE	Shinde.	Shinde.	
35	Kodam Apung S.	Mech.	Kodam	Kodam	
36	Thorat Shritej S.	CSE	Thorat	Thorat	
37	shinde Sushant. B.	civil	shinde	shinde	
38	Rohan Nimbalkar	CSE	Rohan	Rohan	
39	Vaishnavi Chavon	CSE	Chavon	Chavon	
40	Simran Mulla	Mech	Simran	Simran	
41	Tanuja Patil	CSE	Patil	Patil	
42	Patil Vaishnavi Sandip	ESTC	Patil	Patil	
43	Dubal Anjali Jaywant	E & TC	Dubal	Dubal	
44	chavon Vaishnavi Ramchandra	E & TC	Chavon	Chavon	
45	Borbade Sakshi Anil	CSE	Borbade.S.A	Borbade.S.A	
46	Jorag Ankita Tanaji	CSE	Jorag	Jorag	
47	sawant Aditi Akshay	CSE	A.A.sawant	A.A.sawant	
48	Sunase Rutuja Arun	CSE	Sunase	Sunase	
49	More priti Hanmant	CSE	More	More	
50	mahamuni vaidhimilini	CSE	Mahamuni	Mahamuni	
51	Thorat Sanika P.	E & TC	Thorat	Thorat	
52	patil Ananya Ashok	CSE	Ananya	Ananya	
53	Vandekar Vishakha D.	Mech.	Vandekar	Vandekar	
54	Thorat sakshi Anand	E & TC	Thorat	Thorat	
55	Patil Sanika Sanjay	E & TC	Patil	Patil	
56	Mahamuni Jyoti Sateshi	Mech	Mahamuni	Mahamuni	
57	Borkar Samruddhi Prakash	CSE	Borkar	Borkar	
58	shumal Pratiksha Pramod	CSE	PPDHUMAL	PPDHUMAL	
59	Gavate Sakshi Mahesh	CSE	Gavate	Gavate	
60	Kamble Vaishnavi Vikas	CSE	V.V.Kamble	V.V.Kamble	
61	Jadhav Vedika Sharad	CSE	Jadhav	Jadhav	
62	Naigade Anati Bharad	CSE	Naigade	Naigade	
63	Nangare Uttarakshi Uday	CSE	Nangare	Nangare	
64	Jadhav Smarvani S.	CSE	Jadhav	Jadhav	
65	Kumbhar Vaishnavi	ESTC	Vaishnavi	Vaishnavi	
66	Godee Sakshi	E & TC	Godee	Godee	
67	Salunkhe Vishakha	CSE	Salunkhe	Salunkhe	
68	more Vishakha	E & TC	More	More	
69	More Shweta	E & TC	More	More	
70	kevale Pallavi	E & TC	Kevale	Kevale	
71	Deshmukh Siddhi	E & TC	Siddhi	Siddhi	
72	Khutale Pranali	E & TC	Khutale	Khutale	



G.K. Gujar Memorial Charitable Trust's
Dr. Ashok Gujar Technical Institute's,
Dr. Daulatrao Aher College of Engineering, Karad.
Vidyanagar Ext. Banawadi, Tal. Karad 415124, Dist. Satara, Maharashtra INDIA

Department of Basic Sciences & Humanities

Sr. No.	Name of Student	Branch	10.00am to 12.00pm	1.00pm to 5.00pm	Sign.
73	Patil Anpila	E & TC	Patil	Patil	
74	Bukkam Sanika	E & TC	Sankar		
75	Jadhav Nishwari	E & TC	Ashwari	Ashwari	
76	Patil Sanchita	Mech	Patil	Patil	
77	Mohite Sakshi	Mech	S. Mohite	S. Mohite	
78	Mahajan Hitesh	Mech	Patil	Patil	
79	Kadam Tejas	E & TC	Kadam	Kadam	
80	Jadhav Shivraj	E & TC	Jadhav	Jadhav	
81	Jangid Nishant	E & TC	N. Jangid	N. Jangid	
82	Lohar Akanksh	Civil	Lohar		
83	Jangam Onkar	E & TC	Jangam		
84	Sanket Suryawanshi	E & TC	Sanket	Sanket	
85	Mujawar Shamir	Mech	Mujawar	Mujawar	
86	Patil Tushar	Mech	Patil	Patil	
87	More Anand	E & TC	M. More	M. More	
88	S. J. P. Pawar	CSE	S. J. P.	S. J. P.	
89	Wagh Pratik	ENTC	P. D. Wagh	P. D. Wagh	
90	Jangale Ayaz Anand	Civil	Jangale		
91	Abhisek Mali	CS	Abhisek	Abhisek	
92	Shivam Desai	Mech	Shivam	Shivam	
93	Tawar Prasad	Mech	Tawar	Tawar	
94	Harsh Shinde	Mech	Harsh	Harsh	
95	Avadhut Yadav	CSE	Avadhut	Avadhut	
96	Ayush Mane	CSE	Ayush	Ayush	
97	Prathmesh Nikam	CSE	Prathmesh	Prathmesh	
98	Mane Adesh	ENTC	Mane	Mane	
99	Anand Mohit	ENTC	Anand	Anand	
100	Inkar Jadhav	ENTC	Inkar		
101	Patil Sajid	ENTC	Patil	Patil	
102	Patil Rohan	C.S.E	R. S. Patil	R. S. Patil	
103	Arate Prem	C.S.E	Arate	Arate	
104	Subham Chauhan	C.S.E	S. K. C.	S. K. C.	
105	Chetan Kamble	C.S.E	Chetan	Chetan	
106	Pranil Lumbhaya	E & TC	Pranil	Pranil	
107	Pavan Gaikwad	E & TC	Pavan	Pavan	
108	Patil Nikar	CSE	Patil	Patil	
109	Abhisek Kulkarni	Civil	Abhisek	Abhisek	
110	Vishwani Thakur	CSE	Vishwani	Vishwani	
111	Chewale Rachana	CSE	Chewale	Chewale	



G.K. Gujar Memorial Charitable Trust's
 Dr. Ashok Gujar Technical Institute's,
 Dr. Daulatrao Aher College of Engineering, Karad.
 Vidyanagar Ext. Banawadi, Tal. Karad 415124, Dist. Satara, Maharashtra INDIA

Department of Basic Sciences & Humanities

Sr. No.	Name of Student	Branch	10.00am to 12.00pm	1.00pm to 5.00pm	Sign.
112	Padhi Anshaya	CSE	<u>Padhi</u>	<u>Padhi</u>	
113	Pannaal Pranjali	CSE	<u>Pannaal</u>	<u>Pannaal</u>	
114	Ghadage Aditi	Ente	<u>Ghadage</u>	<u>Ghadage</u>	
115	Yelpate Valshravi	Ente	<u>Yelpate</u>	<u>Yelpate</u>	
116	Ghalkh Suzan	CSE	<u>Ghalkh</u>	<u>Ghalkh</u>	
117	Suryawanshi Sanjay	Civil	<u>Suryawanshi</u>	<u>Suryawanshi</u>	
118	Vagare Sanika	Civil	<u>Vagare</u>	<u>Vagare</u>	
119	Chavan Sakshi	Civil	<u>Chavan</u>	<u>Chavan</u>	
120	Aga Abzar	Mech	<u>Aga</u>	<u>Aga</u>	
121	Bhosale Prathmesh	Civil	<u>Bhosale</u>	<u>Bhosale</u>	
122	Chape Anurag	Mech	<u>Chape</u>	<u>Chape</u>	
123	Ghosal Anantkumar	CSE	<u>Ghosal</u>	<u>Ghosal</u>	
124	Tavak Indrajit	E & TC	<u>Tavak</u>	<u>Tavak</u>	
125	Yadav Ruchresh	Mech	<u>Yadav</u>	<u>Yadav</u>	
126	Sanket Jujar	CSE	<u>Sanket</u>	<u>Sanket</u>	
127	Atharv Kshitij	CSE	<u>Atharv</u>	<u>Atharv</u>	
128	Kokare Jitesh	Mech	<u>Kokare</u>	<u>Kokare</u>	
129	Shete Anshu R.	CSE	<u>Shete</u>	<u>Shete</u>	
130	Chavan Shambhuj	CSE	<u>Chavan</u>	<u>Chavan</u>	
131	Mulani Sabita	CSE	<u>Mulani</u>	<u>Mulani</u>	
132	Bhosale Swapnil	E & TC	<u>Bhosale</u>	<u>Bhosale</u>	
133	Tofan Shukh	Mech	<u>Tofan</u>	<u>Tofan</u>	
134	Mulik Vedika	E & TC	<u>Mulik</u>	<u>Mulik</u>	
135	Aditi Ghadage	E & TC	<u>Aditi</u>	<u>Aditi</u>	
136	Mahamuni Vaidehi	CSE	<u>Mahamuni</u>	<u>Mahamuni</u>	
137	Bhoite Dhanashree	CSE	<u>Bhoite</u>	<u>Bhoite</u>	
138	Patil Shreyas Rajendra	CSE	<u>Patil</u>	<u>Patil</u>	
139	Tate Nikita Rajesh	E & TC	<u>Tate</u>	<u>Tate</u>	
140	Shinde Shradha Prakash	E & TC	<u>Shinde</u>	<u>Shinde</u>	
141	Adake Sumpt V.	Mech	<u>Adake</u>	<u>Adake</u>	
142	Nangare Uttaraisha Ubay	CSE	<u>Nangare</u>	<u>Nangare</u>	
143	Shinde Aditi Sunil	ENTC	<u>Shinde</u>	<u>Shinde</u>	
144	Kevala Pallavi Bandu	E & TC	<u>Kevala</u>	<u>Kevala</u>	
145	Ganud Amruta Jitendra	Mech	<u>Ganud</u>	<u>Ganud</u>	
146	Nalaj Akshay Ramesh	CSE	<u>Nalaj</u>	<u>Nalaj</u>	
147	Lokhande Pankaj	ENTC	<u>Lokhande</u>	<u>Lokhande</u>	
148	Jorag Ank		<u>Jorag</u>	<u>Jorag</u>	
149	Jamale Kiran G	ENTC	<u>Jamale</u>	<u>Jamale</u>	
150	Shradha Prakash Shinde	ENTC	<u>Shinde</u>	<u>Shinde</u>	



G.K. Gujar Memorial Charitable Trust's
 Dr. Ashok Gujar Technical Institute's,
 Dr. Daulatrao Aher College of Engineering, Karad.
 Vidyanagar Ext. Banawadi, Tal. Karad 415124, Dist. Satara, Maharashtra INDIA

Department of Basic Sciences & Humanities

Sr. No.	Name of Student	Branch	10.00am to 12.00pm	1.00pm to 5.00pm	Sign.
151	Yudhvir Ritesh Surti	Mech	<i>[Signature]</i>	<i>[Signature]</i>	
152	Shaavan Gurav	E&TC	<i>[Signature]</i>	<i>[Signature]</i>	
153	Dalange Shainesh	E&TC	Shainesh	Shainesh	
154	Sabale Ganesh	E & TC	<i>[Signature]</i>	<i>[Signature]</i>	
155	Parekh Aditya	Mech	<i>[Signature]</i>	<i>[Signature]</i>	
156	Tapale Amit	E&TC	<i>[Signature]</i>	<i>[Signature]</i>	
157	Tasif Shakir	E&TC	Tasif	Amit	
158	Vijay Patil	CSE	Vijay	Tasif	
159	Rushikesh Surve	E & TC	<i>[Signature]</i>	<i>[Signature]</i>	
160	Kumbhar Rohan	E & TC	<i>[Signature]</i>	<i>[Signature]</i>	
161	Pranil Patil	ESE	<i>[Signature]</i>	<i>[Signature]</i>	
162	Suryap Salunke	Mech	<i>[Signature]</i>	<i>[Signature]</i>	
163	Irfan Shake	Mech	<i>[Signature]</i>	<i>[Signature]</i>	
164	Aditya Yashve	Mech	Aditya	Aditya	
165	Dinkar Nandkumar	E & TC	O.M.N.	O.M.N.	
166	M.T. Mulla	E & TC	M.T.M	M.N.	
167	Aspish Pawar	CSE	Aspish	Aspish	
168	Siddhanta Isambhar				
169	Siddhanta Isambhar		<i>[Signature]</i>	<i>[Signature]</i>	
170	Anish Patil		<i>[Signature]</i>	<i>[Signature]</i>	
171	Dra. Theemesha Surve				
172	Aiinkya Kumbhar	CSE	<i>[Signature]</i>	<i>[Signature]</i>	
173	Sanika Patil	E&TC	Patil	Sanika	
174	Chavan Sakshi	Civil	<i>[Signature]</i>	<i>[Signature]</i>	
175	Shewale Rachana	CSE	Shewale	Shewale	
176	Sakshi Gavate	CSE	Gavate	Gavate	
177	Gaikwad Vaishnavi D.	E&TC	<i>[Signature]</i>	<i>[Signature]</i>	
178	Kamble Vaishnavi V.	ISE	V.V.Kamble	V.V.Kamble	
179	Chavan Valudha	Civil	V.K.Chavan	V.K.Chavan	
180	Kumbhar Vaishnavi	E&TC	<i>[Signature]</i>	<i>[Signature]</i>	
181	Patwekar Alisha	CSE	<i>[Signature]</i>	<i>[Signature]</i>	
182	Jadhav Onkar	E&TC	<i>[Signature]</i>	<i>[Signature]</i>	
183	Vyankatesh Velpatkar	CSE	<i>[Signature]</i>	<i>[Signature]</i>	
184	Jangam Onkar	E&TC	Jangam	Jangam	
185	Sanket Surve	E&TC	<i>[Signature]</i>	<i>[Signature]</i>	
186	Harsh Vitendra Veer	E&TC	<i>[Signature]</i>	<i>[Signature]</i>	
187	Patil Priti Anil	Civil	Patil	Patil	
188	Jangam Anil Anandrao	Civil	<i>[Signature]</i>	<i>[Signature]</i>	
189	Kadam Poothamesha	CSE	<i>[Signature]</i>	<i>[Signature]</i>	



G.K. Gujar Memorial Charitable Trust's
 Dr. Ashok Gujar Technical Institute's,
 Dr. Daulatrao Aher College of Engineering, Karad.
 Vidyanagar Ext. Banawadi, Tal. Karad 415124, Dist. Satara, Maharashtra INDIA

Department of Basic Sciences & Humanities

Sr. No.	Name of Student	Branch	10.00am to 12.00pm	1.00pm to 5.00pm	Sign.
190	Kavyanjali V.C	Mech	Kavyanjali	Kavyanjali	
191	Vishwakarma B.G.	Mech	Vishwakarma	Vishwakarma	
192	Prathmesh S. Surve	CSE	Prathmesh	Prathmesh	
193	Prathmesh Nikam	CSE	Prathmesh	Prathmesh	
194	Ayush Mane	CSE	Ayush	Ayush	
195	Arati Donge	Mech	Arati	Arati	
196	Anjali Dubal	EA	Anjali	Anjali	
197	Nikhil Chavan	Mech	Nikhil	Nikhil	
198	Tejasvi Shinde	Ente	Tejasvi	Tejasvi	
199	Smita Mulla	Mech	Smita	Smita	
200	Buktam Sanika	EITC	Buktam	Buktam	

Pravin Kumar
 Programme Coordinator

Pravin Kumar
 HOD



G.K. Gujar Memorial Charitable Trust's
Dr. Ashok Gujar Technical Institute's,
Dr. Daulatrao Aher College of Engineering, Karad.
Vidyanagar Ext. Banawadi, Tal. Karad 415124, Dist. Satara, Maharashtra INDIA

Department of Basic Sciences & Humanities

Soft Skills Training

Academic Year 2022-23

Attendance of F. Y. B. Tech

Date: 28/12/2022

Sr. No.	Name of Student	Branch	Session-I	Session-II
1	Prathamesh V. Bhopate	Civil	Bhopate	Bhopate
2	Abzar Mustafa Aga	Mech	Abzar	Abzar
3	Maaz Nasrullah Mulga	E&TC	Maaz	Maaz
4	Sidharth Mahadik	Mech	S.M.	S.M.
5	Aadhiraj Sunil Panaskar	Civil	Aadhiraj	Aadhiraj
6	Kumbhar Vivek Sukhadew	E&TC	Kumbhar	Kumbhar
7	Kotkar Jitesh Manohar	Mech	Kotkar	Kotkar
8	Patil Ananya Ashok	CSE	Ananya	Ananya
9	Botkar Samruddhi Prakash	CSE	Botkar	Botkar
10	Kumbhar Sakshi Vishwas	Mech	Kumbhar	Kumbhar
11	Padar Anshika Sumanlal	CSE	Padar	Padar
12	Thorat Vaishnavi Sachin	CSE	Thorat	Thorat
13	Survase Rutuja Arun	CSE	Survase	Survase
14	Dhumal Pratiksha Pramod	CSE	PPDHUMAL	PPDHUMAL
15	Suryawanshi Sanjana Vijay	Civil	Sanjana	Sanjana
16	Trivedi Asiya Mukhtar	CSE	Trivedi	Trivedi
17	Garud Amruta Jitendra	Mech	Garud	Garud
18	Patil Vaishnavi Sandip	E&TC	Patil	Patil
19	Najam Akshay Ramchandra	CSE	A.R. Najam	A.R. Najam
20	Khadale Pranali Dattatray	E&TC	Khadale	Khadale
21	Jadhav Aishwary Namdev	E&TC	Aishwary	Aishwary
22	Rohan Sushilkumar Nimbalkar	CSE	Rohan	Rohan
23	Yadav Avadhut Balpurao	CSE	Avadhut	Avadhut
24	Patil Vaishnavi Bhupakesh	E&TC	Patil	Patil
25	Pawar Sanika Rahul	CSE	Pawar	Pawar
26	Bhoite Dhanashree S.	CSE	Bhoite	Bhoite
27	Jadhav Vedika Sharad	CSE	Jadhav	Jadhav
28	Sakshi Appasaheb Godse	E&TC	Sakshi	Sakshi
29	Salunkhe Vishakha	CSE	Salunkhe	Salunkhe
30	Jadhav Shivraj Gajanan	E&TC	Jadhav	Jadhav
31	Mahajan Hitesh Prashant	Mech	Mahajan	Mahajan
32	Tangir Nishant Madhava	E&TC	Tangir	Tangir
33	Kote Vivek Dadasaheb	E&TC	Kote	Kote



G.K. Gujar Memorial Charitable Trust's
Dr. Ashok Gujar Technical Institute's,
Dr. Daulatrao Aher College of Engineering, Karad.
Vidyanagar Ext. Banawadi, Tal. Karad 415124, Dist. Satara, Maharashtra INDIA

Department of Basic Sciences & Humanities

Sr. No.	Name of Student	Branch	Session-I	Session-II
34	Kadom Tejesh Suresh	E & TC	Patil	Salunke
35	Indrajeet Rajesh Bakhare	C.S.E.	Sankar	Sankar
36	Vyanfatesh Rajendra Vaspatrak	C.S.E.	Vank	Vank
37	Shriya Naimi Mihajwani	Mech	Shriyaman	Shriyaman
38	Sankeet Sandip Suryawanshi	E & TC	Sanket	Sanket
39	Onkar Suryakant Jangam	E & TC	Jangam	Jangam
40	Shriate, Saugji Thorat	CSE	Shriate	Shriate
41	Atali Bharat Naigade	CSE	Atali	Atali
42	Shweta Shankar Mane	E & TC	Shweta	Shweta
43	Janhavi Vilas Chhore	CSE	Chhore	Chhore
44	Shinde Sanika Anil	CSE	Shinde	Shinde
45	Kamble Vaishnavi Vikas	CSE	V.V.Kamble	V.V.Kamble
46	Kumbhar Vaishnavi Pramod	ESTC	Vaishnavi	Vaishnavi
47	Maganjori Jyoti Sadashiv	Mech	Jyoti	Jyoti
48	Gaikwad Vaishnavi Dipak	E & TC	Gaikwad	Gaikwad
49	Palange Shrinesh Karan	E & TC	Palange	Palange
50	Shahid Tohuf Yakub	E & TC	Shahid	Shahid
51	Bhosale Swapnil Anandaji	E & TC	Bhosale	Bhosale
52	Pawar Ashish Shivaji	CSE	Ashish	Ashish
53	Pawar Sangtam Jalindar	CSE	S.J.P.	S.J.P.
54	Kafare Akash Shivaji	E & TC	Akash	Akash
55	Patil Vijay Popat	CSE	Patil	Patil
56	Surve Rushikesh Sambhaji	E & TC	Surve	Surve
57	Gavale Sakshi Mahesh	CSE	Gavale	Gavale
58	Shewale Rachana Suryakant	CSE	Shewale	Shewale
59	Patil Sanika Sanjay	E & TC	Patil	Patil
60	Shinde Harsh Ajit	Mech	Shinde	Shinde
61	Tarag Ankita Ranaji	CSE	Tarag	Tarag
62	Thorat Sanika Prakash	E & TC	Thorat	Thorat
63	More Vishakha Satish	E & TC	More	More
64	Jamale Kiran Gorakh	E & TC	Jamale	Jamale
65	Salunkhe Kastik Jatinam	E & TC	Salunkhe	Salunkhe
66	Mane Rajnandini Pradip	E & TC	Mane	Mane
67	Acharya Prarth Vinod	Mech.	Acharya	Acharya
68	Wagh Pratik Dhanaji	ENTC	P.D.Wagh	P.D.Wagh
69	More Aadesh Manik.	E & TC	More	More
70	Adalce Sumit V.	Mech	Adalce	Adalce
71	Ingaavale Aya Anandrao	civil	Ingaavale	Ingaavale
72	Patil Priti Anil	civil	Patil	Patil
73	Shinde Shradha Prakash	ENTC	Shinde	Shinde



G.K. Gujar Memorial Charitable Trust's
Dr. Ashok Gujar Technical Institute's,
Dr. Daulatrao Aher College of Engineering, Karad.
Vidyanagar Ext. Banawadi, Tal. Karad 415124, Dist. Satara, Maharashtra INDIA

Department of Basic Sciences & Humanities

Sr. No.	Name of Student	Branch	Session-I	Session-II
114	Tate Nikita Rajendra	ENTC	Nate	Nate
115	Patil Sanchita Ramchandra	mech	Satil	Satil
116	Kevale Pallavi Bandy	E&TC	Kevale	Kevale
117	Shinde Aditi Sunil	ENTC	Ashinde	Ashinde
118	Kadam Apurva Sandip	Mech.	Radam	Radam
119	Nangare Uttarksha Uday	CSE	Uttarksha	Uttarksha
120	Ghulap Anjali Ramesh	Entc	ARGhulap	ARGhulap
121	Mulik Vedika Adhikara	E&TC	Mulik	Mulik
122	Barkode Sakshi Anil	CSE	Barkode.s.a	Barkode.s.a
123	Ghadage Aditi Anil	ENTC	Adhikara	Adhikara
124	mahamuni vajdehi Milind	ESE	Mahamuni	Mahamuni
125	Karande Sankalp Sanjay	F&TC	S	S
126	Mane Sahil Santosh	Civil	Mane	Mane
127	Salunkhe Swapnil Sanjay	Mech	Salunkhe	Salunkhe
128	Shaikh Jorhan Jamil	Mech	Shaikh	Shaikh
129	Chavan shubham krishnat	CSE	Shubham	Shubham
130	chavan nikhil mandar	ME	n.m.c.	n.m.c.
131	veer harsh	E&TC	H. Veer	H. Veer
132	Patil Rohan sambhaji	CSE	R.S.Patil	R.S.Patil
133	surve Prathmesh shivnath	C.S.E	Surve	Surve
134	Gautsali shrawan vinayak	E&TC	Gautsali	Gautsali
135	Vaishnavi satish yelpale	ENTC	Vaishnavi	Vaishnavi
136	Priti Hanmant More	CSE	Priti	Priti
137	Vaishnavi Ramchandra Chavan	E&TC	Vaishnavi	Vaishnavi
138	Lokhande Rushikesh shrawan	E&TC	Lokhande	Lokhande
139	Cosikereed Puneeth	E&TC	Cosikereed	Cosikereed
140	Kumbhar Ravit tanngj	E&TC	Kumbhar	Kumbhar
141	Pathan Sajid Zakirhusan	E&TC	Pathan	Pathan
142	AJAT Samir shikalgar	E&TC	AJAT	AJAT
143	Ajinkya Kiran Kumbhar	CSE	A.K.K.	A.K.K.
144	Shirde Vignesh Tanaji	Civil	Shirde	Shirde
145	Shirsat Subhas Suresh	Mech	Shirsat	Shirsat
146	Omkar Navadkar	E&TC	Omkar	Omkar
147	Attharv Kabisagar	CSE	Attharv	Attharv
148	Aashish Rajendra Shete	CSE	Aashish	Aashish
149	Shambhuj Chavan	CSE	Shambhuj	Shambhuj
150	Omkar Perti	CSE	Omkar	Omkar
151	Abh. Kulkarni	Civil	Abh.	Abh.
152	Vaibhav Bagal	CSE	Vaibhav	Vaibhav
153	Devkar Hemant Anil	CSE	Devkar	Devkar



G.K. Gujar Memorial Charitable Trust's
Dr. Ashok Gujar Technical Institute's,
Dr. Daulatrao Aher College of Engineering, Karad.
Vidyanagar Ext. Banawadi, Tal. Karad 415124, Dist. Satara, Maharashtra INDIA

Department of Basic Sciences & Humanities

Sr. No.	Name of Student	Branch	Session-I	Session-II
74	Sanket Manikrao Jujar	CSE	Sanket	Sanket
75	Anant Gheral	CSE	Anant	Anant
76	Therat Sakshi Ananda.	EETC	Therata	Therata
77	Shankh Suzan Ajam	CSE	Shankh	Shankh
78	Chavan vaishnavi Lalad	CSE	Chavan	Chavan
79	Tate Prem vasant	CSE	Tate	Tate
80	Shivam Desai	mech	Shivam	Shivam
81	Abhishek mali	CSE	Abhishek	Abhishek
82	Tawar Prasad	mech	Tawar	Tawar
83	Rohit Tanuja Rajendra	CSE	Rohit	Rohit
84	Deshmukh Siddhi Virsinh	EETC	Siddhi	Siddhi
85	Pawar Maithili Dattatray	ENTC	Maithili	Maithili
86	Jadhav Shravani	CSE	Jadhav	Jadhav
87	Pranil Patil	WE	Pranil	Pranil
88	Ayash Sanil Mane	CSE	Ayash	Ayash
89	Sabham Bhagale	ENTC	Sabham	Sabham
90	Rohan Kumbhar	CSE	Rohan	Rohan
91	Ganesh Sabale	EETC	Ganesh	Ganesh
92	Amit Hat Topale	EETC	Amit	Amit
93	Aditya Sawant	EETC	Aditya	Aditya
94	Prathamesh Nikam	CSE	Prathamesh	Prathamesh
95	Anjali Dubal	EETC	Anjali	Anjali
96	Rahul Bate	CSE	Rahul	Rahul
97	Patil Arpita	EETC	Patil	Patil
98	Bukkam Sanika	EETC	Bukkam	Bukkam
99	Shinde Tejasri	Ente	Tejasri	Tejasri
100	Dange Arati	Mech	Dange	Dange
101	Mulla Simran	mech	Mulla	Mulla
102	Nadaf Imran	CSE	Nadaf	Nadaf
103	Sahil Chavan	Mech	Sahil	Sahil
104	Chetan Kambale	CSE	Chetan	Chetan
105	Tovale Anshul	EETC	Tovale	Tovale
106	Kalburgi Aditi Shaikant	CSE	Kalburgi	Kalburgi
107	Talabhe Poochi Balaabey	ENTC	Talabhe	Talabhe
108				
109				
110				
111				
112				
113				



G.K. Gujar Memorial Charitable Trust's
Dr. Ashok Gujar Technical Institute's,
Dr. Daulatrao Aher College of Engineering, Karad.
Vidyanagar Ext. Banawadi, Tal. Karad 415124, Dist. Satara, Maharashtra INDIA

Department of Basic Sciences & Humanities

Soft Skills Training

Academic Year 2022-23

Attendance of F. Y. B. Tech

Date: 29/12/2022

Sr. No.	Name of Student	Branch	Session-I	Session-II
1	Chavan Vaishnavi Lalaso	CSE	Chavan	Chavan
2	Shankh Suzan Ajam	CSE	Shankh	Shankh
3	Thorat Sakshi Ananda	E&TC	Thorat	Thorat
4	Vishwakarma B. G.	Mech	Vishwakarma	Vishwakarma
5	Sanket Manikrao Jujar	CSE	Sanket	Sanket
6	Ghorai Anantkumar Hanmant	CSE	Ghorai	Ghorai
7	Shete Aashish Rajendra	CSE	Shete	Shete
8	Devkar Hemant Anil	CSE	HA Devkar	HA Devkar
9	Aga Abrar Mustafa	Mech	Aga	Aga
10	Bhark Pathmesh V	Civil	Bhark	Bhark
11	Shinde Harsh Ajit	Mech	Harsh	Harsh
12	Patil Vijay Papat	CSE	Patil	Patil
13	Kapre Akash SHIVAJI	E&TC	Kapre	Kapre
14	Surve Rushikesh Sambhaj	E&TC	Surve	Surve
15	Shewale Rachana Suryakanth	CSE	Shewale	Shewale
16	Patil Sabika Sanjay	E&TC	Patil	Patil
17	More Adesh manik	E&TC	AMore	AMore
18	Botkar Samruddhi Prakash	CSE	Botkar	Botkar
19	Nikita Rajesh Tate	E & TC	Nikita	Nikita
20	Shraddha Prakash Shinde	E & TC	shinde	Shinde
21	Harsh vitendra veer	E & TC	Harsh	Harsh
22	Sawant Aditi Akshay	CSE	sawant	Sawant
23	Patil Ananya Ashok	CSE	ananya	ananya
24	Chadri Anshika Farmanali	CSE	Chadri	Chadri
25	Kumbhar Sakshi Vishwas	Mech	kumbhar	kumbhar
26	Kotabe Jitesh Madhukar	Mech	Kotabe	Kotabe
27	Kumbhar Vivek Sukhadev	E & T. C.	Kumbhar	Kumbhar
28	Sangram Jalindarpawar	CSE	S. J. P	S. J. P
29	VyanKatesh Rajendra Khatpathak	C.S.E.	VK	VK
30	Indrajeet Rajesh Rakhare	C.S.E.	Indrajeet	Indrajeet
31	Sanket Sandip Suryawanshi	E&TC	Sanket	Sanket
32	Shruti Sayaji Thorat	C.S.E	Shruti	Shruti
33	Atati Bharad Naigade	CSE	Atati Naigade	Atati Naigade



G.K. Gujar Memorial Charitable Trust's
Dr. Ashok Gujar Technical Institute's,
Dr. Daulatrao Aher College of Engineering, Karad.
Vidyanagar Ext. Banawadi, Tal. Karad 415124, Dist. Satara, Maharashtra INDIA

Department of Basic Sciences & Humanities

Sr. No.	Name of Student	Branch	Session-I	Session-II
34	Tanhari Vilas Ghore	CSE	Tanhari	Dange
35	Nangare Utkarsha Uday	CSE	@Utkarsha	@Utkarsha
36	Kadam Apurva Sandip	Mech	Kadam	Kadam
37	Kevala Pallavi Bonda	E&TC	Kevala	Kevala
38	Shinde Aditi Sunil	ENTC	Ashinde	Ashinde
39	Patil Sonchita Ramchandra	mech	Patil	Patil
40	Ingvale Anya Anandrao	civil	Ingvale	Ingvale
41	Ashiket Sanjay Kale	ENTC	A.S. Kale	A.S. Kale
42	Patil Dhanaji Wagh	ENTC	P.D. Wagh	P.D. Wagh
43	Jangam Onkar Suryakant	E&TC	Jangam	Jangam
44	More priti Harman	ESE	More	More
45	Vaishnavi Satish Yelvale	ENTC	Vaishnavi	Vaishnavi
46	Alshwarya Jadhav	ENTC	Alshwarya	Alshwarya
47	Shikalgar Aaji samir	E&TC	Shikalgar	Shikalgar
48	Shavan Shubham Krishna	CSE	Shavan	Shavan
49	Ashish Shivaji Pawar	CSE	A.S.P.	A.S.P.
50	Ajnya kiran Kumbhar	CSE	A.K.K.	A.K.K.
51	Surve Prathmesh Shivnath	CSE	Surve	Surve
52	Gurukul Shekhar Vinayak	E&TC	Gurukul	Gurukul
53	Shivam Desai	mech	Shivam	Shivam
54	Tate Prem Vasant	CSE	Tate	Tate
55	Sabale Ganesh Mahan	E&TC	Sabale	Sabale
56	Shirde Vighnesh Tanaji	civil	Shirde	Shirde
57	Tejas Suresh Kadam	E&TC	Tejas	Tejas
58	Jangid Nishant Madanid	E&TC	Jangid	Jangid
59	Jadhav Shivraj Gajanan	E&TC	Jadhav	Jadhav
60	Kate Vivek Dadasaheb	E&TC	Kate	Kate
61	Jadhav Vedika Shant	CSE	Jadhav	Jadhav
62	Godse Sakshi Appasaheb	E&TC	Godse	Godse
63	Salunkhe Vishakha	CSE	Salunkhe	Salunkhe
64	Bhoite Dhanashree	CSE	Bhoite	Bhoite
65	Pawar Sanika Rahul	CSE	Pawar	Pawar
66	Nikam Prathamesh Mansing	CSE	Nikam	Nikam
67	Ayush Sunil Mane	CSE	Ayush	Ayush
68	Kumbhar Rohan Rajaram	CSE	Kumbhar	Kumbhar
69	Rahul Ashok Bode	CSE	Rahul	Rahul
70	Kumbhar Pranit Tanaji	E&TC	Kumbhar	Kumbhar
71	Patil Arpita Suresh	E&TC	Patil	Patil
72	Dange Arati Shrikant	Mech	Dange	Dange
73	Dubal Anjali Jaywant	E&TC	Dubal	Dubal



G.K. Gujar Memorial Charitable Trust's
Dr. Ashok Gujar Technical Institute's,
Dr. Daulatrao Aher College of Engineering, Karad.
Vidyanagar Ext. Banawadi, Tal. Karad 415124, Dist. Satara, Maharashtra INDIA

Department of Basic Sciences & Humanities

Sr. No.	Name of Student	Branch	Session-I	Session-II
74	Topale Amit Lakshman	E&TC	Amit	Amit
75	Patil Tanuja Rajendra	CSE	Patil	Patil
76	Adeshmuth Siddhi Viresinh	E&TC	Adeshmuth	Adeshmuth
77	Mohite Sakshi Devidas	Mech	admohite	admohite
78	Pawar Maithili Dattatray	ENTC	Maharaj	Maharaj
79	Indray Shrivani Sahas	CSE	Indray	Indray
80	Chavan Nikhil Manohar	Mech	Nikhavan	Nikhavan
81	onkars Balasa Naik	E&TC	onkars	onkars
82	Ranganil Patil	CSE	Ranganil	Ranganil
83	Tawar Prasad	Mech	Tawar	Tawar
84	Abhishek Arun Mali	CSE	Abhishek	Abhishek
85	Chavan Shambhuj D	CSE	Shally	Shally
86	Chavan kavayajali V.	Mech	Chavayajali	Chavayajali
87	Patil vaishnavi Bhanuday	E&TC	Patil	Patil
88	Gosud Amruta Jitendra	Mech	Gosud	Gosud
89	Khutale Pranali Dattatray	E & T C	Pranali	Pranali
90	Patil Vaishnavi Sandip	E&TC	Patil	Patil
91	Rohan Sushilkumar Nimbalkar	CSE	Rohan	Rohan
92	Vadav Anandhul Papurao	CSE	Anandhul	Anandhul
93	AKSHAY Ramchandra Nayan	CSE	A.R. Nayan	A.R. Nayan
94	Kushik Jitesham salunkhe	E&TC	Kushik	Kushik
95	Adake Sumit V.	Mech	Adake	Adake
96	Acharya Parth Vinod	Mech	Parth	Parth
97	Mane Rajnandini Pradip	E&TC	Mane	Mane
98	More Vishakha Satish	E&TC	More	More
99	Katande Komal Shejareng	E & T C	Katande	Katande
100	Thorat Sanika Prakash	E&TC	Thorat	Thorat
101	Jamale kiran Gorakh	E & T C	Katamale	Katamale
102	Jang Ankita Tanaji	CSE	Jang	Jang
103	Patil Priti Anil	civil	Patil	Patil
104	Shinde Sonika Anil	CSE	Shinde	Shinde
105	Swapnil Shahaji Bhosate	E&TC	Shasate	Shasate
106	Shaikh Tahir Yaqub	E&TC	Shaikh	Shaikh
107	Palange shainesh Kailash	E&TC	Palange	Palange
108	Pathan Sajid Zakirhusen	E&TC	Pathan	Pathan
109	Omkar Navadkar	E & T C	Omkar	Omkar
110	Sahil Shankar Chavan	Mech	Sahil	Sahil
111	Anand Mohite	ENTC	Anand	Anand
112	Pavan Sushant Gaikwad	ENTC	Gaikwad	Gaikwad
113	Indrajy Balasaheb Tarate	ENTC	Tarate	Tarate



G.K. Gujar Memorial Charitable Trust's
Dr. Ashok Gujar Technical Institute's,
Dr. Daulatrao Aher College of Engineering, Karad.
Vidyanagar Ext. Banawadi, Tal. Karad 415124, Dist. Satara, Maharashtra INDIA

Department of Basic Sciences & Humanities

Sr. No.	Name of Student	Branch	Session-I	Session-II
114	Nadaf Imran Babasa	CSE	Nadaf	Nadaf
115	Chetan Dhanaji Kamble	CSE	Kamble	Kamble
116	Kalburgi Aditi Shrikant	CSE	Kalburgi	Kalburgi
117	Mulla Simran Yusuf	Mech.	Mulla	Mulla
118	Shinde Tejashri Nivas	Entc	Tejashri	Tejashri
119	Bukkam Sanika Graunhar	E&TC	Bukkam	Bukkam
120	Gaikwad Vaishnavi Dipak	E&TC	Gaikwad	Gaikwad
121	Magarji Jyoti Galashiv	Mech	Magarji	Magarji
122	Kamble Vaishnavi Vikas	CSE	V.V.Kamble	V.V.Kamble
123	Shikh Jyoti Jamir	Mech	Shikh	Shikh
124	Karande Sankalp Sanjay	E&TC	Karande	Karande
125	Aditya Siddhant Sewart	E&TC	Aditya	Aditya
126	Mane Sahil Santosh	Civil	Mane	Mane
127	Todhar Ankar Lalasa	E&TC	Todhar	Todhar
128	Bagal Vaibhav Ravindra	CSE	Bagal	Bagal
129	Ghadage Aditi Anil	Entc	Ghadage	Ghadage
130	Gholap Anjali Ramesh	Entc	Gholap	Gholap
131	mahamuni Vaidehi Milind	CSE	Mahamuni	Mahamuni
132	Borkade Sakshi Anil	CSE	Borkade.S.A	Borkade.S.A
133	Mulik Vedika Adhikar	ERTC	Mulik	Mulik
134	Salunke Swaraj Sanjay	Mech	Salunke	Salunke
135	Patil Omkar Rajkumar	CSE	Patil	Patil
136	Kadam Prathmesh Manoj	CSE	Kadam	Kadam
137	Manojan Kitesh Prashant	Mech	Manojan	Manojan
138	Prof. J.B. Chavan	-	Prof. J.B. Chavan	Prof. J.B. Chavan
139	_____ Sabiya Mulani	CSE	Sabiya	Sabiya
140	Dhumal Pratiksha Pramod.	CSE	PRDHUMAL	PRDHUMAL
141	Survase Rutuja Anu	CSE	Survase	Survase
142	Inamdar Asiya Mukhtar	CSE	Inamdar	Inamdar
143	Abade Swapnil Krishnat	CSE	Abade	Abade
144	Suryawanshi Sanjana Vijay	Civil	Suryawanshi	Suryawanshi
145	Aadhircu Sunil Parasker	Civil	Aadhircu	Aadhircu
146	Lokhande Rushikesh Shreed	Entc	Lokhande	Lokhande
147	Rhonia Najem Mujawar	Mech.	Rhonia	Rhonia
148	Yadav Ritesh Sunil	Mech	Yadav	Yadav
149	Tadake Pradu Balasaheb	Entc	Tadake	Tadake
150	Bukkam Sanika Graunhar	E&TC	Bukkam	Bukkam
151				
152				
153				

Prof. J.B. Chavan

29/12/22
4:45pm



G.K. Gujar Memorial Charitable Trust's
Dr. Ashok Gujar Technical Institute's,
Dr. Daulatrao Aher College of Engineering, Karad.
Vidyanagar Ext. Banawadi, Tal. Karad 415124, Dist. Satara, Maharashtra INDIA

Training and Placement Cell

DACOE / FED / FRM 06

FED- FRM 06- Rev. No: 0 Date:

STUDENTS TRAINING FEEDBACK FORM

Date:

Name of the Expert Person : Mr. Gini George

Name of the Topic : Soft Skills Training (F.Y. B.Tech.) (26-12-2022 to 30-12-2022)

Designation & Organization: Director- Shashwatgyan Learning and Development

Name of the Participant : Anati Bharat Nuigade Dept. CSE

Note: Please tick on the appropriate option

Sr.No	Parameters / Rating	Outstanding	Excellent/ Useful	Best	Good	Average
1	Overall Session	<input checked="" type="checkbox"/>				
2	Session Content		<input checked="" type="checkbox"/>			
3	Quality of Handouts			<input checked="" type="checkbox"/>		
4	Session Length			<input checked="" type="checkbox"/>		
5	Trainer(s) Knowledge	<input checked="" type="checkbox"/>				
6	Pace of Training				<input checked="" type="checkbox"/>	
7	Exercises & Lab Session			<input checked="" type="checkbox"/>		
8	I had fun			<input checked="" type="checkbox"/>		
9	I learnt something useful	<input checked="" type="checkbox"/>				

1) What did you like about the programme?

It's perfect for teaching business, communication skills and other similar competencies.

2) What do you think could be improved?

Five days training is really excellent there is no need to improvement.

3) Outline THREE things that you will take with you/have learnt in this session

1) Communication skill

2) Teamwork

3) Interaction

4) Any other comments

Sign of Participant



G.K. Gujar Memorial Charitable Trust's
Dr. Ashok Gujar Technical Institute's,
Dr. Daulatrao Aher College of Engineering, Karad.
Vidyanagar Ext. Banawadi, Tal. Karad 415124, Dist. Satara, Maharashtra INDIA

Training and Placement Cell

DACOE/FED/FRM 06

FED- FRM 06- Rev. No: 0 Date:

STUDENTS TRAINING FEEDBACK FORM

Date:

Name of the Expert Person : Mr. Gini George

Name of the Topic : Soft Skills Training (F.Y. B.Tech.) (26-12-2022 to 30-12-2022)

Designation & Organization: Director- Shashwatgyan Learning and Development

Name of the Participant : Aashish Rajendra Shete Dept. CSE

Note: Please tick on the appropriate option

Sr.No	Parameters / Rating	Outstanding	Excellent/ Useful	Best	Good	Average
1	Overall Session	<input checked="" type="checkbox"/>				
2	Session Content		<input checked="" type="checkbox"/>			
3	Quality of Handouts	<input checked="" type="checkbox"/>				
4	Session Length		<input checked="" type="checkbox"/>			
5	Trainer(s) Knowledge	<input checked="" type="checkbox"/>				
6	Pace of Training	<input checked="" type="checkbox"/>				
7	Exercises & Lab Session	<input checked="" type="checkbox"/>				
8	I had fun	<input checked="" type="checkbox"/>				
9	I learnt something useful	<input checked="" type="checkbox"/>				

1) What did you like about the programme?

The session of Sir was amazing, we learnt a lot from him. Sir made us think on lot of questions.

2) What do you think could be improved?

I don't think so, that he should improve cause he is best.

3) Outline THREE things that you will take with you/have learnt in this session

- To take commitment
- To seek knowledge everywhere
- I gained confidence.

4) Any other comments

We want Sir next year too.

Sign of Participant



G.K. Gujar Memorial Charitable Trust's

G.K. Gujar Memorial Charitable Trust's

**Dr. Ashok Gujar Technical Institute's,
Dr. Daulatrao Aher College of Engineering, Karad.**

Vidyanagar Ext. Banawadi, Tal. Karad 415124, Dist. Satara, Maharashtra INDIA

Basic sciences and Humanities

Soft Skill Training Report

Report

Date and Duration: 26th December to 30th December 2022. Everyday: 10.00 am to 5.00 pm (30hrs)

Number of beneficiaries: 180 students and faculty members

Name and details of Trainer: Mr. G. George, trainer Shashwatgyan, Learning and Development, Pune.

Objective: To understand and learn various aspects of soft skills. To create confidence in a student's mind.

Brief Write up on the Training: Soft Skills training was arranged by Department of Basic Sciences and Humanities for all F. Y. B. Tech. Student under the guidance of Dept. Head, Prof. V. B. Suryawanshi. Programme Coordinators were Dr. S. S. Nangare and Prof. M. L. Kamble. Soft Skills training was conducted from 26th Dec. To 30th Dec. 2022 for all F. Y. B. tech student. Soft Skills training was started with felicitation of guest, Mr. G. George and motivational speech by our Principal, Dr. A. M. Mulla. Soft Skills training of the Trainer, named, Mr. G. George was really enthusiastic person. He covers various topics related to soft skills likes Discover yourself, Eradicate Fear, Set your goals, Build your confidence and communication skills during training session. Soft Skills training was really interesting and informative. All the students actively participated in the discussion and activities during the training. This training was really useful for the newly admitted, first year student. Dr. S. S. Nangare, addressed the formal vote of thanks. The training finally ended with a group photograph session.

Learning outcome: Students and faculty members learnt about Soft skills various aspects: Discover yourself, eradicate Fear, set your goals, build your confidence and communication skills, with examples.

S. S. Nangare

Programme Coordinator



V. B. Suryawanshi
HOD

Head of Dept.
Basic Science & Humanities
Dr. Ashok Gujar Technical Institute's
Dr. Daulatrao Aher College of Engineering, Karad



G.K. Gujar Memorial Charitable Trust's
 Dr. Ashok Gujar Technical Institute's,
 Dr. Daulatrao Aher College of Engineering, Karad.
 Vidyanagar Ext. Banawadi, Tal. Karad 415124, Dist. Satara, Maharashtra INDIA

DACOE / FED / FRM 05

FED- FRM 05 - Rev. No: 0 Date:

Training and Placement Cell

STUDENTS TRAINING FEEDBACK FORM

Note: Please tick on the appropriate option
 Date: 26/12/2022 to 30/12/ 2022

Name of the Expert Person/ organization: Mr. Gini George
 Designation & Organization: Trainer : Director- Shashwatgyan Learning and Development
 Branch: F.Y. B.Tech. ALL Time: 10:00 am to 4:00 pm Venue: Auditorium

Note: Please tick on the appropriate option

Sr.No.	Name of the students	Branch & Class	Outstanding	Excellent/ Useful	Best	Average
1.	Aadhiraj Sunil Panasker	Civil	✓			
2.	Mage Nasrati Murali	E&TC	✓			
3.	Swapnil Krishnat Abadar	CSE	✓			
4.	Omkar Rajkumar Patil	CSE	✓			
5.	AGiya Mukhtas Inandae	CSE	✓			
6.	Vaishnavi Sachin Thorat	CSE	✓			
7.	Pratiksha Pramod Dhumal	CSE	✓			
8.	Sonjona Vijay Suryawanshi	Civil	✓			
9.	Rutuja Arun Survasse	CSE	✓			
10.	Bhoite Dhanashree S.	CSE	✓			
11.	Pawar Sanika Rahul	CSE	✓			
12.	Godse Sakshi Appasaheb	E&TC	✓			
13.	Jadhav Vedika Shradha	CSE	✓			
14.	Mahajan Hitesh Mahajan	Mech	✓			
15.	Jangid Nishant Mahendra	ENTC	✓			
16.	Kate Vivek Dadasaheb	E&TC	✓			
17.	Kadam Tejas Suresh	E&TC	✓			
18.	Jangam Ankoj Suryakant	E&TC	✓			
19.	Gharal Anantkumar.Hi	CSE		✓		
20.	Gaikwad Pavan Sushant	E&TC	✓			
21.	Chavan Sahil Shankar	Mech	✓			
22.	Tavate Indrajit Babasaheb	E&TC	✓			
23.	Chetan Dhasaji Kambale	CSE	✓			
24.	Imran Babasa Nardaf	CSE	✓			
25.	Pathan Sajid Zakirhusen	E&TC	✓			
26.	Sanket Manikrao Tujar	CSE		✓		
27.	Mulla Simran Yusuf	Mech	✓			
28.	Shinde Tejaswri Nivars	ENTC	✓			
29.	Tadakte Praachi Babasaheb	ENTC		✓		



DACOE/FED/FRM 05

FED- FRM 05 - Rev. No: 0 Date:

Training and Placement Cell

STUDENTS TRAINING FEEDBACK FORM

Note: Please tick on the appropriate option

Sr.No.	Name of the students	Branch & Class	Outstanding	Excellent/ Useful	Best	Average
30.	Sanika Ganuwar Bulekar	E&TC	✓			
31.	Aditi Walburgi	CSE	✓			
32.	Apurna S. Kadam	Mech	✓			
33.	Sanika P. Thorat	E&TC	✓			
34.	Ankita Jagat	CSE	✓			
35.	Kiran G. Jamale	E&TC	✓			
36.	Rajrandini P. Mane	E&TC	✓			
37.	Prath V. Acharya	Mech	✓			
38.	Salunke Karthik Jitendra	E&TC	✓			
39.	Sakshi Atmaram Kutekar	CSE	✓			
40.	Aashish R. Shete	CSE	✓			
41.	Kavyanjali A. Chavan	Mech	✓			
42.	Devkar Hemant Anil	CSE	✓			
43.	Taran Jatin Shalkh	Mech	✓			
44.	Salunke Swapnil Sanjay	Mech	✓			
45.	Kamble Vaishnavi Vikas	CSE	✓			
46.	Gaikwad Vaishnavi Dipak	E & TC	✓			
47.	Bhosale Swapnil Shubham	E&TC	✓			
48.	Palange Shubhash Kulkarni	E&TC	✓			
49.	Shankar Tejendra Yakub	E&TC	✓			
50.	Bagal Vaibhav Ravindra	CSE	✓			
51.	Jadhav Anuraj Lalase	E&TC	✓			
52.	Mahamuni Vaidhimilind	CSE	✓			
53.	Patil Vedika Adhikar	E&TC	✓			
54.	Borkade Sakshi Anil	CSE	✓			
55.	Ghadage Aditi Anil	E&TC	✓			
56.	Gholap Anjali Ramesh	E&TC	✓			
57.	Karande Sankalp	E&TC	✓			
58.	Mane Sahil Santosh	Civil	✓			
59.	Prathamesh V. Bhopate	Civil	✓			
60.	Shinde Harsh Ajit	Mech	✓			
61.	Pawar Ashish Shivaji	CSE	✓			
62.	Patil Vijay Popal	CSE	✓			
63.	Surve Rushikesh Sambhaj	E&TC	✓			
64.	Shewale Rachana Suryakant	CSE	✓			
65.	Patil Sanika Sanjay	E&TC	✓			
66.	Kapre Akash Shivaji	E&TC	✓			



G.K. Gujar Memorial Charitable Trust's
Dr. Ashok Gujar Technical Institute's,
Dr. Daulatrao Aher College of Engineering, Karad.
Vidyanagar Ext. Banawadi, Tal. Karad 415124, Dist. Satara, Maharashtra INDIA

DACOE/FED/FRM 05

FED- FRM 05 - Rev. No: 0 Date:

Training and Placement Cell

STUDENTS TRAINING FEEDBACK FORM

Note: Please tick on the appropriate option

Sr.No.	Name of the students	Branch & Class	Outstanding	Excellent/ Useful	Best	Average
67.	Ajinkya kiran kumbhar	CSE	✓			
68.	Surve Prathmesh	CSE	✓			
69.	Shikagar Ajaj	E&TC	✓			
70.	Chavan shubham	CSE	✓			
71.	Gutsale shraavan	E&TC	✓			
72.	Patil Rohan	CSE	✓			
73.	Yelpale Vaishnavi	ENTC	✓			
74.	More priti Honmant	CSE	✓			
75.	Harsh - Veer	ENTC	✓			
76.	Shraddha Shinde	ENTC	✓			
77.	Rohan S. Vimbalkar	CSE	✓			
78.	Patil Vaishnavi Sandip	E&TC	✓			
79.	Yadav Anandhut Bapurao	CSE	✓			
80.	Khutale Pranali Dattatray	E&TC	✓			
81.	Patil Vaishnavi Bhanudas	E&TC	✓			
82.	Garud Amruta Jitendra	Mech	✓			
83.	Akshay Ramchandra Neer	CSE	✓			
84.	Patil Tushar Vilas	Mech	✓			
85.	shirsat sahad saresh	Mech	✓			
86.	Patil Anish Sunil	Mech	✓			
87.	Khumbhar rohan baban	ENTC	✓	✓		
88.	Yadav Ritesh Sunil	Mech	✓	✓		
89.	Shinde Rishant	Civil	✓	✓	✓	✓
90.	omkar Pawar	Civil	✓	✓	✓	✓
91.	Kumbhar Rohan Ajay	CSE	✓			
92.	Rahul Ashok Bode	CSE	✓			
93.	Kumbhar Pranit Tanaji	E&TC	✓			
94.	Topale Amit laxman	E&TC	✓	✓		
95.	Savant Aditya Siddhant	E&TC	✓	✓		
96.	Anpita patil	E&TC	✓			
97.	Arati Dange	Mech	✓			
98.	Anjali Dubal	E&TC	✓			
99.	Prathamesh Nikam	CSE	✓			
100.	Ayush Sunil Maje	CSE	✓			
101.	Nikita Rajesh Tate	E&TC	✓			
102.	Aditi savant	CSE	✓			
103.	Kumbhar Sakshi	Mech	✓	✓		



G.K. Gujar Memorial Charitable Trust's
Dr. Ashok Gujar Technical Institute's,
Dr. Daulatrao Aher College of Engineering, Karad.
Vidyanagar Ext. Banawadi, Tal. Karad 415124, Dist. Satara, Maharashtra INDIA

DACOE/FED/FRM 05

FED- FRM 05 - Rev. No: 0 Date:

Training and Placement Cell

STUDENTS TRAINING FEEDBACK FORM

Note: Please tick on the appropriate option

Sr.No.	Name of the students	Branch & Class	Outstanding	Excellent/ Useful	Best	Average
104.	Botkar Samruddhi Prakash	CSE	✓			
105.	Kerkare Jitesh Madhulal	Mech	✓			
106.	Mumbhar Vivek S	ENTC	✓			
107.	Qadri Aarshya F.	CSE	✓			
108.	Mubani Sabiya Gani	CSE	✓			
109.	Patil Ananya Ashok	CSE	✓			
110.	Adake Sumit V.	Mech	✓			
111.	Sangram Pawade	CSE	✓			
112.	Patil Sanchita Ramchandra	mech	✓			
113.	Patil Priti Anil	civil	✓			
114.	Nanavare Uttarsha Uday	CSE	✓			
115.	Shinde Aditi Sunil	ENTC	✓			
116.	Keval e pallavi Bandy	E&TC	✓			
117.	Getare Janhavi Vilas	CSE	✓			
118.	Shinde Sanika Anil	CSE	✓			
119.	Naigade Aradi Bharat	CSE	✓			
120.	Mane shweta shankar	E & TC	✓			
121.	Sharma Najem Musajwar	Mech.	✓			
122.	Indrajeet Rajesh Pakhare	C.S.E.	✓			
123.	Vyankatesh Rajendra Velpethkar	C.S.E.	✓			
124.	Sanket Sandip Suryawanshi	EdTC	✓			
125.	Shmiles Shyaji Thorat	C.S.E.	✓			
126.	Mogankar Jyoti Sadasri	Mech	✓			
127.						
128.						
129.						
130.						
131.						
132.						
133.						
134.						
135.						
136.						
137.						
138.						
139.						
140.						



WELCOME

Mr. Gini George



G. K. Gujar Memorial Charitable Trust's
Dr. Ashok Gujar Technical Institute's
Dr. Daulatrao Aher College of Engineering, Karad
Accredited by NAAC with B+ & ISO 9001-2008 Certified Institute
Training & Placement Cell

DACOE/ TPO/2022-2023/

Date 06/01/2023

Training Notice for TY & B. Tech. All Branches

All the TY, B. Tech & B. Tech. all branches are hereby informed to note that, **Technical C, C++, Python, Soft Skills & Aptitude Training** is scheduled as per following schedule. All the students should attend the Training, as this Training is very much crucial for Placement drive preparation.

Sr.No.	Name of the Training	Duration & Time	Class & Branch	Batch	Venue
1	Technical Training C, C++ & Python By GTT, Pune	30 th Jan. To 1 st Feb. 2023 9:30 to 5:00	TY- CSE & ENTC	A	Class Room & Labs
2	Technical Training C, C++ & Python By GTT, Pune	30 th Jan. To 1 st Feb. 2023 9:30 to 5:00	B.Tech.- CSE & ENTC	B	Class Room & Labs
3	Soft Skills – Employability Skills 24 hrs By Rubicon, Pune	2 nd Feb. to 4 th Feb. 2023 9:30 to 5:00	TY- CSE & ENTC B.Tech.- CSE & ENTC TY- MECH & CIVIL B.Tech.- MECH & CIVIL	A B C D	Class Rooms
4	Aptitude Training 24 hrs By FUEL, Pune	6 th Feb. to 8 th Feb. 2023 9:30 to 5:00	TY- CSE, ENTC, MECH & CIVIL	A	Auditorium
5	Aptitude Training 24 hrs By FUEL, Pune	9 th Feb. to 11 th Feb. 2023 9:30 to 5:00	B. Tech.- CSE, ENTC, MECH & CIVIL	B	Auditorium

Mr. P. D. Bansode
Training & Placement Officer



Dr. Ashok Gujar Technical Institute's
Dr. Daulatrao Aher College of Engineering, Karad
Soft Skills Training by- Rubicon, Pune

Date : 02/02/2023 to 04 /02/2023 Venue: CR

Time: 10:00 am to 5: 00 pm

Date: 03/02/2023

Class: TY & B-Tech

Branch: Civil Engineering

Sr.No	Candidates Name	Class & Branch	Mob.No.	Session-I Sign.	Session-II Sign.
1	Jadhav Shraddha M.	TY	8482802402	Jadhav	Jadhav
2	Dingane Prachi R.	TY	8888064325	Dingane	Dingane
3	Juwar Tejaswi S.	TY	8010503075	Juwar	
4	Jadhav Dhiraj S.	TY	7620976798	Jadhav	Jadhav
5	Kadam Anuja C.	TY	8080357319	Kadam	Kadam
6	Patil Trupti S.	TY	7038271734	Patil	Patil
7	Mulla Ratiya N.	TY	737864708	Mulla	Mulla
8	Thorat Nehal D.	B.Tech	8623802610	Thorat	Thorat
9	Jadhav Anabi	e	7743983750	Jadhav	Jadhav
10	Patil Bhagyashri	e	8669415644	Patil	Patil
11	Nalawade Vrushali	e	8600913652	Nalawade	Nalawade
12	chunnade shubhada	e	8421600087	chunnade	chunnade
13	Hattigote Prerana	B.Tech	9359552547	Hattigote	Hattigote
14	Janugade Pronav A.	T.Y	9145787662	Janugade	Janugade
15	Waghmare Ankita	B.Tech	9579076689	Waghmare	Waghmare
16	Mali Rohit S.	B.Tech	9881977479	Mali	Mali
17	Mose Rahul S.	B.Tech	8530313545	Mose	Mose
18	Nimbalkar Tanmay	B.Tech	721885727	Nimbalkar	Nimbalkar
19					
20					
21					
22					
23					
24					
25					



Dr. Ashok Gujar Technical Institute's
Dr. Daulatrao Aher College of Engineering, Karad
Soft Skills Training by- Rubicon, Pune

Date : 02/02/2023 to 04 /02/2023 Venue: CR

Time: 10:00 am to 5: 00 pm

Date: 3/2/2023

Class: B.Tech

Branch: ENTC

Sr.No	Candidates Name	Class & Branch	Mob.No.	Session-I Sign.	Session-II Sign.
1	Shravani Shete	B.tech	7219897004	<i>[Signature]</i>	<i>[Signature]</i>
2	Nikita Jadhav	B.Tech	8378894288	<i>[Signature]</i>	<i>[Signature]</i>
3	Ningadale Sneha kalyans	B.Tech	7387744886	<i>[Signature]</i>	<i>[Signature]</i>
4	Shinde shradha	B.tech	9665149606	<i>[Signature]</i>	<i>[Signature]</i>
5	Varsha Kamble	B.Tech	7040040146	<i>[Signature]</i>	<i>[Signature]</i>
6	Autade Rutuja	B.tech	9527760592	<i>[Signature]</i>	<i>[Signature]</i>
7					
8					
9					
10					
11					
12					
13					
14					
15					
16					
17					
18					
19					
20					
21					
22					
23					
24					
25					



Dr. Ashok Gujar Technical Institute's
Dr. Daulatrao Aher College of Engineering, Karad
Soft Skills Training by- Rubicon, Pune

Date : 02/02/2023 to 04 /02/2023 Venue: CR

Time: 10:00 am to 5: 00 pm

Class: T.Y.

Branch: Mech

Date: 3/2/2023

Sr.No	Candidates Name	Class & Branch	Mob.No.	Session-I Sign.	Session-II Sign.
1	More Pratik Satish	T.Y. Mech	8010782805		
2	Desai Shivam Ashok	T.Y. Mech	8432196358		
3	Mahadik Aniruddha A	T.Y. Mech	8412085605		
4	Shirwadkar Sahil Pravin	B.Tech	9921253802		
5	Jamale Tushar Nuthuram	T.Y. Mech	9370518219		
6	Pol Shivam Rajendra	T.Y. ME	9158406519		
7	Sawant Safranj Suresh	T.Y. ME	7387741999		
8	Nikam Hrishikesh Kuddip	T.Y. ME	9284313241		
9					
10					
11					
12					
13					
14					
15					
16					
17					
18					
19					
20					
21					
22					
23					
24					
25					



Dr. Ashok Gujar Technical Institute's
Dr. Daulatrao Aher College of Engineering, Karad
Soft Skills Training by- Rubicon, Pune

Date : 02/02/2023 to 04 /02/2023 Venue: CR

Time: 10:00 am to 5: 00 pm

Date: 31/02/2023

Class:

Branch: CSE

Sr.No	Candidates Name	Class & Branch	Mob.No.	Session-I Sign.	Session-II Sign.
1	Pawar Dhanashri Nitin	T.Y.B.Tech	9022449491	<u>Pawar</u>	<u>Pawar</u>
2	Mane Radhika Rajendra	B.Tech	7719894931	<u>R.R.mane</u>	
3	Gharge Pranali Kalyan	B.Tech	9689515411	<u>Gh</u>	
4	Maithili Vasant Tirmaxe	B.Tech	9067373396	<u>Maithili</u>	
5	Neha Nitin Pansande	B.Tech	7249739306	<u>Neha</u>	
6	Archana Raju Ushijwal	T.Y.B.Tech	8485856454	<u>Archana</u>	<u>Archana</u>
7	Diya Ramjan Inamdaz	T.Y.B.Tech	7709102458	<u>Diya</u>	<u>Diya</u>
8	Sanika Anil Nalawade	T.Y.B.Tech	9822766875	<u>Sanika</u>	<u>Sanika</u>
9	Sayama Dilawar Mujawar	T.Y.B.Tech	7720044636	<u>Sayama</u>	<u>Sayama</u>
10	Asmita Yuvraj Kate	T.Y.B.Tech	9552458004	<u>Asmita</u>	<u>Asmita</u>
11	Jadhav Snehal Sanjay	T.Y.B.Tech	7264038042	<u>Jadhav</u>	<u>Jadhav</u>
12	Couto Glenn Gilbert	T.Y.B.Tech	7774970731	<u>Glenn</u>	<u>Glenn</u>
13	Moolya Nidhish Narayan	T.Y.B.Tech	9370217137	<u>Moolya</u>	<u>Moolya</u>
14	Shine Jayan Christyan	T.Y.B.Tech	721969804	<u>Shine</u>	<u>Shine</u>
15	Vishal Ramkrishna Patil	T.Y.B.Tech	9730220101	<u>Vishal</u>	
16	Pragati Mahesh Patil	B.Tech	9834151913	<u>Pragati</u>	
17	Mrunali Nanasa Shinde	B.Tech	9762880575	<u>Mrunali</u>	
18	Diksha Rajesh Adsule	B.Tech	9145247025	<u>Diksha</u>	
19	Nibita Mukund Adake	B.Tech	9146728122	<u>Nibita</u>	
20	Patil Vaishnavi Ashok	T.Y.CSE	7498409271	<u>Patil</u>	<u>Patil</u>
21					
22					
23					
24					
25					



Dr. Ashok Gujar Technical Institute's
Dr. Daulatrao Aher College of Engineering, Karad
Soft Skills Training by- Rubicon, Pune

Date : 02/02/2023 to 04 /02/2023 Venue: CR

Time: 10:00 am to 5: 00 pm

Date: 4-2-2023

Class:

Branch:

Sr.No	Candidates Name	Class & Branch	Mob.No.	Session-I Sign.	Session-II Sign.
1	Akshay Ramchandra Nixan	CSE	9970086502	A.R.Nixan	
2	chetan Dhanaji Kambale	CSE	9545042604	Kambale	
3	Prathamesh Mansing Nikam	CSE	9579166142	Nikam	
4	Sahil Santosh Mane	Civil	8668839019	Mane	
5	Sangram Jalindar Pawar	CSE	8856855898	S.J.P	
6	Pranil Gorakh Patil	CSE	7709476853	Patil	
7	Gharal Anantkumar.H.	CSE	7498720772	Gharal	
8	Thorat Shritej Sayaji	CSE	8830777791	Thorat	
9	Bagal Vaibhav Ravindra	CSE	9665027385	Bagal	
10	Panwal Pranjali Bajirao	CSE	7620305617	Panwal	
11	Mulani sobiya Garzi	CSE	7887844786	Mulani	
12	Inamdar Asiya Mukhtar	CSE	9322083177	Inamdar	
13	Botkar Samruddhi Prakash	CSE	9860865249	Botkar	
14	Dhumal Pratiksha Pramod	CSE	8623986263	PDHUMAL	
15	Gehare Tanhavi Vilas	CSE	9112192260	Gehare	
16	Bhoite Dhanashree Santosh	CSE	8830110285	Bhoite	
17	Patil Ananya Ashok	CSE	8788632698	Ananya	
18	Sakshi Atmaram futankar	CSE	7719076553	Sakshi	
19	Arati Bharat Naigade	CSE	7219898390	Arati	
20	Vedika Sharad Jadhav	CSE	7410737907	Vedika	
21	Uttarksha Uday Nangare	CSE	8767783697	Uttarksha	
22	Vaishnavi Vikas Kambale	CSE	8446200477	Vaishnavi	
23	Vaishnavi Sachin Thorat	CSE	9022387010	Vaishnavi	
24	Aamshlya Faismanalk (Dada)	CSE	9421693496	Aamshlya	
25	vaidehi milind mahamuni	CSE	7498650930	Vaidehi	

Sr.No	Candidates Name	Class & Branch	Mob.No.	Session-I Sign.	Session-II Sign.
26	more Priti Hanmant	CSE	9322772601	<i>Priti</i>	
27					
28					
29					
30					
31					
32					
33					
34					
35					
36					
37					
38					
39					
40					
41					
42					
43					
44					
45					
46					
47					
48					
49					
50					
51					
52					
53					
54					
55					

Name & Sign. of TPC with Date.



Rubicon, Pune



Karad, Maharashtra, India
858W+745, Karad, Maharashtra 415124, India
Lat 17.315349°
Long 74.19528°
07/06/22 04:59 PM



G. K. Gujar Memorial Charitable Trust's
Dr. Ashok Gujar Technical Institute's
Dr. Daulatrao Aher College of Engineering, Karad
Accredited by NAAC with B+ & ISO 9001-2008 Certified Institute
Training & Placement Cell

DACOE/ TPO/2022-2023/

Date 06/01/2023

Training Notice for TY & B. Tech. All Branches

All the TY, B. Tech & B. Tech. all branches are hereby informed to note that, **Technical C, C++, Python, Soft Skills & Aptitude Training** is scheduled as per following schedule. All the students should attend the Training, as this Training is very much crucial for Placement drive preparation.

Sr.No.	Name of the Training	Duration & Time	Class & Branch	Batch	Venue
1	Technical Training C, C++ & Python By GTT, Pune	30 th Jan. To 1 st Feb. 2023 9:30 to 5:00	TY- CSE & ENTC	A	Class Room & Labs
2	Technical Training C, C++ & Python By GTT, Pune	30 th Jan. To 1 st Feb. 2023 9:30 to 5:00	B.Tech.- CSE & ENTC	B	Class Room & Labs
3	Soft Skills – Employability Skills 24 hrs By Rubicon, Pune	2 nd Feb. to 4 th Feb. 2023 9:30 to 5:00	TY- CSE & ENTC B.Tech.- CSE & ENTC TY- MECH & CIVIL B.Tech.- MECH & CIVIL	A B C D	Class Rooms
4	Aptitude Training 24 hrs By FUEL, Pune	6 th Feb. to 8 th Feb. 2023 9:30 to 5:00	TY- CSE, ENTC, MECH & CIVIL	A	Auditorium
5	Aptitude Training 24 hrs By FUEL, Pune	9 th Feb. to 11 th Feb. 2023 9:30 to 5:00	B. Tech.- CSE, ENTC, MECH & CIVIL	B	Auditorium

Mr. P. D. Bansode
Training & Placement Officer



Dr. Ashok Gujar Technical Institute's
Dr. Daulatrao Aher College of Engineering, Karad
Aptitude Training by- FEUL, Pune

Date : 06/08/2023 to 08/02/2023 Venue: CR

Time: 9:30 am to 5: 30 pm

Date: 6/2/2023

Class: T.Y.

Branch: Mechanical.

Sr.No	Candidates Name	Mob.No.	Session-I Sign.	Session-II Sign.
1	Rutvik Sunil Velhal	9156992957	<u>Rutvik</u>	<u>Rutvik</u>
2	Mohesh sadashiv Bobade	9579060098	<u>Mohesh</u>	<u>Mohesh</u>
3	Desai Shivam Ashok	8432196358	<u>Desai</u>	<u>Desai</u>
4	Mahadik Aniruddha A.	8412085605	<u>Mahadik</u>	<u>Mahadik</u>
5	Patil Sangram maruti	7219480483	<u>Patil</u>	<u>Patil</u>
6	Kokare Vishwajeet shankar	9284387067	<u>Kokare</u>	<u>Kokare</u>
7	Kamble Aditya Dilip	9922067752	<u>AK</u>	<u>AK</u>
8	Kumbhar Avishkar S.	7057832609	<u>ASK</u>	<u>ASK</u>
9	Jamale Tuskar Natharom	9370518219	<u>Jamale</u>	<u>Jamale</u>
10	Digane Omkar Shivaji	8830444197	<u>Omkar</u>	<u>Omkar</u>
11	More Pratik Satish	8010762605	<u>More</u>	<u>More</u>
12	Pawar Abhishek shashikant	9579352526	<u>Pawar</u>	
13				
14				
15				
16				
17				
18				
19				
20				
21				
22				
23				
24				
25				



Dr. Ashok Gujar Technical Institute's
Dr. Daulatrao Aher College of Engineering, Karad
Aptitude Training by- FEUL, Pune

Date : 06/08/2023 to 08/02/2023 Venue: CR

Time: 9:30 am to 5: 30 pm

Date: 6/2/2023

Class: T.Y.

Branch: E&TC

Sr.No	Candidates Name	Mob.No.	Session-I Sign.	Session-II Sign.
1	Dsouza Verissa . P.	7058286016		
2	Mane Vaishnavi J.	7558663262		
3	Patil Shruti . R.	9172370019		
4	Patel APSARA Rashid	9889235307		
5	Patil Rutuja Dilip	9020538900		
6	Shetty Gautami Avinash	9623140669		
7	Mane Shweta Sunil	9325285441		
8	Magdum Swapnali. V.	7083796588		
9	Bhingardeve Vidya G.	7769882534		
10	Pholke Bhagwant Anil	9970698840		
11	Kazi Ayan Nair	8698824640		
12	Nikam Pranav Subhash	7620511847		
13				
14				
15				
16				
17				
18				
19				
20				
21				
22				
23				
24				
25				



Dr. Ashok Gujar Technical Institute's
Dr. Daulatrao Aher College of Engineering, Karad
Aptitude Training by- FEUL, Pune

Date : 06/08/2023 to 08/02/2023 Venue: CR

Time: 9:30 am to 5: 30 pm

Date: 6/2/2023

Class: T.Y.

Branch: Civil.

Sr.No	Candidates Name	Mob.No.	Session-I Sign.	Session-II Sign.
1	Jadhav shraddha M.	8482802402	<u>Shraddha</u>	<u>Shraddha</u>
2	Dingane Prachi R.	8888064325	<u>Dingane</u>	<u>Dingane</u>
3	Jujar Tejaswi S.	8010503075	<u>Jujar</u>	<u>Jujar</u>
4	Bhasme Aishwarya C.	9284188395	<u>Bhasme</u>	<u>Bhasme</u>
5	Janrao Sandhya K.	9145665872	<u>Janrao</u>	<u>Janrao</u>
6	Jadhav Dhiraj S.	7620976798	<u>Jadhav</u>	<u>Jadhav</u>
7	Janugade Pranav A.	9145787662	<u>Janugade</u>	<u>Janugade</u>
8	Kadam Anuja C	8080357319	<u>Kadam</u>	<u>Kadam</u>
9	Patil Tapti sunil	7038271734	<u>Patil</u>	<u>Patil</u>
10	Mulla Rafiya N.	7378647057	<u>Mulla</u>	<u>Mulla</u>
11				
12				
13				
14				
15				
16				
17				
18				
19				
20				
21				
22				
23				
24				
25				



Dr. Ashok Gujar Technical Institute's
Dr. Daulatrao Aher College of Engineering, Karad
Aptitude Training by- FEUL, Pune

Date : 06/08/2023 to 08/02/2023 Venue: CR

Time: 9:30 am to 5: 30 pm

Date: 6/2/2023

Class: B-Tech

Branch: Mechanical

Sr.No	Candidates Name	Mob.No.	Session-I Sign.	Session-II Sign.
1	Patel Shoyab Altaf	9405116024	S.Patel	
2	Patel Aavej Vahid	9834204940	ABH	
3	Shirwadkar srhil Pravin	992753802	Srhil	Srhil
4	Kaakhi Shafaat Ayub	8830119292	Shakhi	
5	M. Juned F. Inamdar	9834088181	J.F.	
6	Pavan Arjun Mane	8669395555	P.Man	
7	Akash Mahan Bhusrani	9096414143	Akash	
8	Durgesh Sanjay Bhusrani	9370600401	D.S.Bhusrani	
9	Vishwajit Dattatray Jaysp	9834387577	V.Jaysp	
10	Vaishnavi S. Pawar	7841991520	V.S.Pawar	
11	Benzir J. Mulla	9284928597	B.J.Mulla	
12				
13				
14				
15				
16				
17				
18				
19				
20				
21				
22				
23				
24				
25				



Dr. Ashok Gujar Technical Institute's
Dr. Daulatrao Aher College of Engineering, Karad
Aptitude Training by- FEUL, Pune

Date : 06/08/2023 to 08/02/2023 Venue: CR

Time: 9:30 am to 5: 30 pm

Date: 6/2/2023

Class: B.Tech

Branch: E&TC

Sr.No	Candidates Name	Mob.No.	Session-I Sign.	Session-II Sign.
1	Karan Desai	9834461556		
2	shradha Dattatray Shinde	9665149606		
3	Shravani Hemant Shete	7219897004		
4	Shivani Sanjay Misal	7275551222	S.S.Misal	S.S.Misal
5	Kalyani pradeep Mahamuni	7397887178	Mahamuni	Mahamuni
6	Ningadale snehal kalyansao	9387744886	S.K.Ningadale	S.K.Ningadale
7				
8				
9				
10				
11				
12				
13				
14				
15				
16				
17				
18				
19				
20				
21				
22				
23				
24				
25				



Dr. Ashok Gujar Technical Institute's
Dr. Daulatrao Aher College of Engineering, Karad
Aptitude Training by- FEUL, Pune

Date : 06/08/2023 to 08/02/2023 Venue: CR

Time: 9:30 am to 5: 30 pm

Date: 6/2/2023

Class: B.Tech

Branch: Civil

Sr.No	Candidates Name	Mob.No.	Session-I Sign.	Session-II Sign.
1	chunnade shubhada K	8421600485	Shubhada	Shubhada
2	waghmare Ankita R	9579076689	Ankita	Ankita
3	Hattigote prerana S	9359552547	Prerana	Prerana
4	Kadam Anuja E.	8080357819	Anuja	
5	Mulla Rafiya H.	7378647057	Rafiya	
6	Patil Trupti S.	7638271734	Trupti	
7	Lade sonal G.	8530508357	Sonal	
8	Rutika R. Pokale	8007697083	Rutika	
9	Nehal D. Thorat	8629802610	Nehal	
10	Nalawade Vrushali S.	8600913652	Vrushali	
11	Jadhav Arati B.	7743983750	Arati	
12	Patil Bhagyashri D.	8669415644	Bhagyashri	
13				
14				
15				
16				
17				
18				
19				
20				
21				
22				
23				
24				
25				



Dr. Ashok Gujar Technical Institute's
Dr. Daulatrao Aher College of Engineering, Karad
Aptitude Training by- FEUL, Pune

18

Date : 06/08/2023 to 08/02/2023 Venue: CR

Time: 9:30 am to 5: 30 pm

Date: 7/02/2023

Class: T.Y (C.S.E)

Branch: CSE

Sr.No	Candidates Name	Mob.No.	Session-I Sign.	Session-II Sign.
1	Prathamesh P. Kumbhar	9561841929	<u>Prathamesh</u>	<u>Prathamesh</u>
2	Omkar B. katy	9763953178	<u>Omkar</u>	<u>Omkar</u>
3	Patil Sugash Jivan	9066813973	<u>Patil</u>	
4	Mohadik Viraj Nitin	8975779161	<u>Viraj M.</u>	<u>Viraj M.</u>
5	Kodulkar omkar Arun	7517752204	<u>Omkar</u>	<u>Omkar</u>
6	Pawar Mayor Pratap	9359298530	<u>MPawar</u>	<u>MPawar</u>
7	Kalaskar Abhishek.	9850073968	<u>Kalaskar</u>	<u>Kalaskar</u>
8	Rizwan muzavar	9774089285	<u>R. muzavar</u>	<u>R. muzavar</u>
9	Bagwan Kamil M. Rafique	8482915286	<u>Kamil Bagwan</u>	<u>Kamil Bagwan</u>
10	shikalgar Juned K.	8169007031	<u>Juned</u>	
11	Mohite Gaurav Ramdas	9021354203	<u>Gaurav</u>	<u>Gaurav</u>
12	pawar pratik Shankar	7219415049	<u>Pratik</u>	<u>Pratik</u>
13	Chorage pratik Arjun	8010719163	<u>Chorage</u>	<u>Chorage</u>
14	Moolya Nidhish Narayan.	4370217137	<u>Nidhish</u>	<u>Nidhish</u>
15	Wastoglenn	7774970731	<u>Wastoglenn</u>	<u>Wastoglenn</u>
16	shubham chavan	9107171117	<u>Shubham</u>	<u>Shubham</u>
17	Omkar Pakhale	8530524197	<u>Omkar</u>	<u>Omkar</u>
18	Prashant chavan	7410598085	<u>Prashant</u>	<u>Prashant</u>
19	Jadhav Snehal	7264038042	<u>Jadhav</u>	<u>Jadhav</u>
20	Kale Asmita	9552458004	<u>Asmita</u>	<u>Asmita</u>
21	Inamdar Diya	7709102458	<u>Inamdar</u>	<u>Inamdar</u>
22	Shejwal Archana	8485856454	<u>Shejwal</u>	<u>Shejwal</u>
23	Shedage Gauri Dhanaji	8550987006	<u>Gauri</u>	<u>Gauri</u>
24	Patil Vaishnavi Ashok	7498409271	<u>Patil</u>	<u>Patil</u>
25	Patil Saylee Sanjay	9766652699	<u>Saylee</u>	<u>Saylee</u>

Sr.No	Complete Name	Mob.No.	Session-I Sign.	Session-II Sign.
26	Pawar Kajal Krishna	9666005251	<u>Pawar</u>	<u>Pawar</u>
27	Shirhat Saloner Pravin	9834710741	<u>Shirhat</u>	<u>Shirhat</u>
28	Shete Sakshi Dhananjay	8956452047	<u>Shete</u>	<u>Shete</u>
29	chorage Ankita chandrakant	7499201441	<u>chorage</u>	
30	karande Neha Ganesh	7751882932	<u>Karande</u>	
31	Charan Tejaswini Dilip	8010814671	<u>Charan</u>	
32	Salunkhe Rucha Sunderb	8010821614	<u>Ruchart</u>	<u>Rucha</u>
33	Gurav Aishwarya Rajendra	9922513571	<u>Gurav</u>	<u>Gurav</u>
34	Lohar Poojapakta Poojash	7020421530	<u>Lohar</u>	<u>Lohar</u>
35	Patil Pranjali Pradip	8485037156	<u>Patil</u>	<u>Patil</u>
36	Sonawale Sakshi Baburao	7391915503	<u>Sonawale</u>	<u>Sonawale</u>
37	Grawade Komal Kiran	7304122863	<u>Grawade</u>	<u>Grawade</u>
38	mulla suhan Jameer	9975488562	<u>Mulla</u>	<u>Mulla</u>
39	Patil Pranjali Sanjay	9423453023	<u>Pranjali</u>	<u>Pranjali</u>
40	Yadav Pratiksha Babasaheb	9028720289	<u>Yadav</u>	
41	Manaji Mahesh Lawand	7058586833	<u>Manaji</u>	<u>Manaji</u>
42	Vassha Varantha Pranjay	9588650699	<u>Vassha</u>	
43	shinde Sanika Sanjay	9356107975	<u>Shinde</u>	
44	Pooja Babasaheb Komale	9325091466	<u>Pooja</u>	<u>Pooja</u>
45	Shreya Dadasa Patil	9021102310	<u>Shreya</u>	<u>Shreya</u>
46	Patil mrunal mahesh	9373501755	<u>Patil</u>	<u>Patil</u>
47	vetal shivanjali Ram Rao	8010118088	<u>Vetal</u>	
48	Korale Aakanksha Chandrakant	9075105104	<u>Korale</u>	
49	Pawar Dhanashri Nitin	9022449491	<u>Pawar</u>	<u>Pawar</u>
50	Uadate Snehal Krishna	7757803415	<u>Uadate</u>	<u>Uadate</u>
51	Shinde Sanika Sandeep	9860851711	<u>Shinde</u>	<u>Shinde</u>
52	Sakshi Mahan Patil	9172396016	<u>Patil</u>	<u>Patil</u>
53	Soyama Dibhate Mujawade	7720044636	<u>Soyama</u>	<u>Soyama</u>
54				
55				



Dr. Ashok Gujar Technical Institute's
Dr. Daulatrao Aher College of Engineering, Karad
Aptitude Training by- FEUL, Pune

Date : 06/08/2023 to 08/02/2023 Venue: CR

Time: 9:30 am to 5: 30 pm

Date: 7/2/2023

Class: B.E. Mech^{EE}/TY mech. Branch: Mechanical.

Sr.No	Candidates Name	Mob.No.	Session-I Sign.	Session-II Sign.	
1					
2	Akash Mohan Bhusari	9096414143			B.E.
3	Rutvik Sunil Velhal	9156992957			T.Y
4	Sujit Dattatray Inambar	8600438451			B.E.
5	Shivam Ashok Desai	8432196358			T.Y
6	Aniruddha A. Mahadik	8412085605			T.Y
7	Durgesh S. Bhusari	9168946791	D.S. Bhusari		B.E.
8	Vishwajit D Jagtap	9834387577			BE
9	Kachhi Saffat Ayub.	880019292			BE
10					
11					
12					
13					
14					
15					
16					
17					
18					
19					
20					
21					
22					
23					
24					
25					



Dr. Ashok Gujar Technical Institute's
Dr. Daulatrao Aher College of Engineering, Karad
Aptitude Training by- FEUL, Pune

Date : 06/08/2023 to 08/02/2023 Venue: CR

Time: 9:30 am to 5: 30 pm

Date: 7/2/2023

Class: B.E (C.S.E)

Branch: CSE

Sr.No	Candidates Name	Mob.No.	Session-I Sign.	Session-II Sign.
1	Sohan Dhanaji Sulez.	9767160938	Sulez	
2	Rutuja Sanjay Kesore	9387993813	R.S.Kesore	
3	Manali Ravikant Jadhav	8208379145	Jadhav	Jadhav
4	Mayuri Sanjay Desai	9870572782	Desai	Desai
5	Nibita Mukund Adake	9146728122	Adake	Adake
6	Mrunali Nanaso Jhinde	9762832575	Jhinde	Jhinde
7	Diksha Rajesh Adsule	9145247025	Adsule	Adsule
8	Maithili Vasant Tromare	9067373396	Tromare	
9	Manali Vijay Potdar	7350382399	Potdar	
10	Shatlaja Shashikant Sathe	8010850378	Sathe	
11	Pranav Sudhir Ghate	7498795701	Ghate	
12	Siddesh Prinjansha Bhandare	8999341264	Bhandare	
13	More Karan Abasaheb	7038936357	More	More
14	Suryawanshi Vishwajit D.	9579816391	Suryawanshi	Suryawanshi
15	Patil Snehal Ramesh	9665723402	Patil	Patil
16	Mayuri Vikas Chavan	8554935834	Chavan	Chavan
17	Priti Vikas More.	9028506092	More	More
18	Aishwarya Prakash Pawar	9021031086	Pawar	Pawar
19	Pratibha S. Patil	9022607510	Patil	Patil
20	Prakta Kamalakar Kumbhar	9307362509	Kumbhar	Kumbhar
21	Toupti Suryakant Patil	8698823161	Patil	Patil
22	Dipti Suryakant Patil	8698823160	Patil	Patil
23	Wangade Kartiki Sanjay	9067460565	Wangade	Wangade
24	Radhika Rajendra More	7719894931	More	More
25	Gharge pranali kayen	9689575411	Gharge	Gharge
26	Tapase harshoda Ashok	9595111395	Tapase	Tapase
27	Neha Nitin Pansarde	7249739306	NNP	NNP
28	Doud Shabbir Mulla	7558706011	Mulla	Mulla
29	Panthe Vivek Garware	9529328167	Panthe	Panthe



Dr. Ashok Gujar Technical Institute's
Dr. Daulatrao Aher College of Engineering, Karad
Aptitude Training by- FEUL, Pune

Date : 06/08/2023 to 08/02/2023 Venue: CR

Time: 9:30 am to 5: 30 pm

Date: 07/02/2023

Class: T.Y (ENTC)

Branch: E&TC

Sr.No	Candidates Name	Mob.No.	Session-I Sign.	Session-II Sign.
1	Kazi Ayan Najir	8698824640	<u>Akazi</u>	
2	Nikam pramod Subhash	7820511847	<u>PSalmon</u>	
3	Phalle Bhagwanant Anil	9970698840	<u>BPhalle</u>	
4	Mane Shweta sunil	9325285441	<u>Shweta</u>	<u>Shweta</u>
5	Lade Tanvi sandesh	7038130510	<u>Tulade</u>	<u>Tanvi</u>
6	Magdum Swapnali Vilas.	7083796588	<u>Smagde</u>	<u>Smagde</u>
7	Patil satyajit Ashok	7083053429	<u>SPatil</u>	
8	Patil Shivraj . s	8530660503	<u>SPatil</u>	
9	Mane Prakash jaysing	9529773755	<u>PRMane</u>	
10	Patil Gauri Tanaji	9579551051	<u>GPatil</u>	
11	Thapa Durva chadrakant	9322657390	<u>TThapa</u>	
12	Salve Dipi Ashok	9356564212	<u>SDi</u>	
13	Dhauja Venissa P	7058286016	<u>Dhauja</u>	
14	Mane Vaishnavi Jeevan	7558668262	<u>JMane</u>	
15				
16				
17				
18				
19				
20				
21				
22				
23				
24				
25				



Dr. Ashok Gujar Technical Institute's
Dr. Daulatrao Aher College of Engineering, Karad
Aptitude Training by- FEUL, Pune

Date : 06/08/2023 to 08/02/2023 Venue: CR

Time: 9:30 am to 5: 30 pm

Date: 7/2/2023

Class: B.E. (E.N.T.) Branch: E&TC

Sr.No	Candidates Name	Mob.No.	Session-I Sign.	Session-II Sign.
1	Karan Desai	9834461556	<u>Desai</u>	<u>Desai</u>
2	Kalyani Mahamuni	7397887178	<u>Mahamuni</u>	<u>Mahamuni</u>
3	Shravani Shete	7219897004	<u>Shete</u>	<u>Shete</u>
4	Nikita Jadhav	8378894288	<u>Jadhav</u>	<u>Jadhav</u>
5	Ningadale Sneha/Kalyani	7387744086	<u>S.K.Ningadale</u>	<u>SK.Ningadale</u>
6	Pratiksha Charan	9730327563	<u>Charan</u>	<u>Charan</u>
7	Shivani Misal	7277551222	<u>S.S.Misal</u>	<u>S.S.Misal</u>
8	Priyanka Pawar	9767363159	<u>Pawar</u>	<u>Pawar</u>
9	Ganesh Khabale	7387069194	<u>G.Khabale</u>	<u>G.Khabale</u>
10	Shradha Shinde	9665149606	<u>Shinde</u>	<u>Shinde</u>
11				
12				
13				
14				
15				
16				
17				
18				
19				
20				
21				
22				
23				
24				
25				



Dr. Ashok Gujar Technical Institute's
Dr. Daulatrao Aher College of Engineering, Karad
Aptitude Training by- FEUL, Pune

Date : 06/08/2023 to 08/02/2023 Venue: CR

Time: 9:30 am to 5: 30 pm

Date: 7/2/2023

Class: BE civil / TY civil Branch: CIVIL

Sr.No	Candidates Name	Mob.No.	Session-I Sign.	Session-II Sign.
1	Waghmare Ankitg	9579076629		
2	Chunnade Shubhada	8421600485		
3	Hattigote prerana	9359552547		
4	Vijar Tejaswi Suresh	8010503075		
5	Malawade Vrushali	8800918652		
6	Jadhav Atati	7743983750		
7	Patil Bhagyashri	8669415644		
8				
9				
10				
11				
12				
13				
14				
15				
16				
17				
18				
19				
20				
21				
22				
23				
24				
25				



Dr. Ashok Gujar Technical Institute's
Dr. Daulatrao Aher College of Engineering, Karad
Aptitude Training by- FEUL, Pune

18

Date : 06/08/2023 to 08/02/2023 Venue: CR

Time: 9:30 am to 5: 30 pm

Date: 8/2/2023

Class: T.Y / BE

Branch: CSE

Sr.No	Candidates Name	Mob.No.	Session-I Sign.	Session-II Sign.
1	Patil Vaishnavi Ashok	7498409271	<u>Vaishnavi</u>	<u>Vaishnavi</u>
2	Mujawar Sayama Dilawar	7720044636	<u>Sayama</u>	<u>Sayama</u>
3	Patil Saylee Sanjay	9766652699	<u>Saylee</u>	<u>Saylee</u>
4	Shirsat Salanee Provin	9834710741	<u>Shirsat</u>	<u>Shirsat</u>
5	Pawar Kajal Krishna	7666005251	<u>Pawar</u>	<u>Pawar</u>
6	Yadav Pratiksha	7028720289	<u>Yadav</u>	
7	Inamdar Diya Ramjan	7709102458	<u>Inamdar</u>	<u>Inamdar</u>
8	Shejwal Arohana Raju	8485856454	<u>Shejwal</u>	<u>Shejwal</u>
9	Kate Asmita Yuvraj	9552458004	<u>Asmita</u>	<u>Asmita</u>
10	Jadhav Snehal Sanjay	7264038042	<u>Jadhav</u>	<u>Snehal</u>
11	Shandare Siddesh Panjabrao	8099346214	<u>Sandare</u>	
12	Mulla Davud Shabbir	7558706011	<u>D.S.mulla</u>	<u>D.S.Mulla</u>
13	Chavan Shubham Sanjay	9107171117	<u>Shubham</u>	<u>Shubham</u>
14	Patil Aishwina Babasaheb	8412017271	<u>Aishwina</u>	
15	Prashant Yuvraj Chavan	7410598085	<u>Prashant</u>	
16	Yadav Vipul Vijay	9763492600	<u>Vipul</u>	
17	Omkar Santosh Pakhale	8530524197	<u>Omkar</u>	
18	Pawar Mayur Pratap	9359298530	<u>Pawar</u>	<u>Pawar</u>
19	Shikalgar Jined Komsuddin	8169007031	<u>Shikalgar</u>	
20	Pawar Pratih Shantkar	7219415049	<u>Pratih</u>	
21	Bagwan Kamil M.Rafique	8482915286	<u>Kamil</u>	
22	Mohite Gaurav Ramdas	9021354203	<u>Mohite</u>	<u>Mohite</u>
23	Saad Mujawar		<u>Saad</u>	<u>Saad</u>
24	Moolya Nishish Narayan	9370217137	<u>Nishish</u>	
25	Carro Glenn Gilbert	7774970781	<u>Carro</u>	
26	Cheistian Shine Jayan	7219649304	<u>Shine</u>	
27	More Karan Abasaheb	7038936357	<u>More</u>	
28	Garware Parth Vivek	9529328107	<u>Garware</u>	
29	Dange Rohit Adhikar	8485873297	<u>Rohit</u>	

Sr.No	Complete Name	Mob.No.	Session-I Sign.	Session-II Sign.
26	mulla suhan Jameer	9975488562	<u>Mulla</u>	<u>Mulla</u>
27	kamble pooja babasaheb	9525091466	<u>Ka</u>	<u>Ka</u>
28	gaode komal kisan	7304122863	<u>Gaode</u>	<u>Gaode</u>
29	Patil psangali sanjay	9423453023	<u>Psangali</u>	<u>Psangali</u>
30	prihi more	7028506092	<u>Prihi</u>	<u>Prihi</u>
31	Pratiksha Patil	9022607570	<u>Pratik</u>	<u>Pratik</u>
32	Prakta Kumbhar	9307362504	<u>Pumbhar</u>	<u>Pumbhar</u>
33	Toupti Patil	8698823161	<u>Toupti</u>	<u>Toupti</u>
34	Mayuri chavan	8554935834	<u>Mayuri</u>	<u>Mayuri</u>
35	Mayuri Yadav	9420841756	<u>Mayuri</u>	<u>Mayuri</u>
36	Samiksha Yadav	9504774747	<u>Syadav</u>	<u>Syadav</u>
37	Aishwarya Pawar	9021031086	<u>AP Pawar</u>	<u>AP Pawar</u>
38	Vaishnavi Kshirsagar	8857087056	<u>Vaishnavi</u>	<u>Vaishnavi</u>
39	Khandagle Dhanshri	7249674690	<u>Dhanshri</u>	<u>Dhanshri</u>
40	Dipti Patil	8698823160	<u>Dshali</u>	<u>Dshali</u>
41	Wangade Kartiki Sanjay	9067460565	<u>Kshirsagar</u>	<u>Kshirsagar</u>
42	shete sakshi dhananjay	8956452047	<u>Shete</u>	
43	Gadole Smtal Krishna	7757803415	<u>Kandale</u>	<u>Kandale</u>
44	Lawand manasi mahesh	7058586833	<u>Manasi</u>	<u>Manasi</u>
45	Poojary Vansha Vasantha	9588650699	<u>Vansha</u>	<u>Vansha</u>
46	yadav pratiksha babasaheb	7028720289	<u>Pradav</u>	<u>Pradav</u>
47	Salunkhe Rucha Sandesh	8010821614	<u>Ruchal</u>	<u>Ruchal</u>
48	Kadam Sakshi Milind	9020541437	<u>Sakshi</u>	<u>Sakshi</u>
49	Sonawale Sakshi Babirao	7391915563	<u>Sakshi</u>	<u>Sakshi</u>
50	Neha Nitin Pansande	7249739306	<u>NNP..</u>	<u>NNP..</u>
51	Matthili Vasant Tismare	9067373396	<u>MVI..</u>	<u>MVI..</u>
52	Gharge Pranali Kalyan	9689515411	<u>Gharge</u>	<u>Gharge</u>
53	Tapase Harshada Ashok	959511395	<u>Tapas</u>	<u>Tapas</u>
54	Shinde Namrata	7774927171	<u>Nand</u>	<u>Nand</u>
55	Radhika Rajendra mane	7719894931	<u>R.R mane</u>	<u>R.R mane</u>



Dr. Ashok Gujar Technical Institute's
Dr. Daulatrao Aher College of Engineering, Karad
Aptitude Training by- FEUL, Pune

Date : 06/08/2023 to 08/02/2023 Venue: CR

Time: 9:30 am to 5: 30 pm

Date: 08/02/2023

Class: TY & B.E

Branch: Civil

Sr.No	Candidates Name	Mob.No.	Session-I Sign.	Session-II Sign.
1	Jadhav Arati	7143983750		
2	Malawade Vrushali	8600913652		
3	Thorat Nehal	8623802610		
4	Patil Bhagyashri	8669415644		
5	More Rahul S.	8530373545		
6	Nimbalkar Tanmay R.	7218857273		
7				
8				
9				
10				
11				
12				
13				
14				
15				
16				
17				
18				
19				
20				
21				
22				
23				
24				
25				



Dr. Ashok Gujar Technical Institute's
Dr. Daulatrao Aher College of Engineering, Karad
Aptitude Training by- FEUL, Pune

Date : 06/08/2023 to 08/02/2023 Venue: CR

Time: 9:30 am to 5: 30 pm

Date: 8/2/2023.

Class: T.Y / B.E.

Branch: Mech

Sr.No	Candidates Name	Mob.No.	Session-I Sign.	Session-II Sign.
1	Pawar Vaishnavi H.	7841991520	VH	
2	Mulla Benzir J	98284928597	BJMulla	
3	Mulani Muskan A	8169689092	MAMulani	
4	Shirwadkar Sahil P.	9921753602	Shirwadkar	Shirwadkar
5	Waghmare Niki S	9834331152	Niki	Niki
6				
7				
8				
9				
10				
11				
12				
13				
14				
15				
16				
17				
18				
19				
20				
21				
22				
23				
24				
25				



Dr. Ashok Gujar Technical Institute's
Dr. Daulatrao Aher College of Engineering, Karad
Aptitude Training by- FEUL, Pune

Date : 06/08/2023 to 08/02/2023 Venue: CR

Time: 9:30 am to 5: 30 pm

Date: 08/02/2023

Class: TY & B.E

Branch: ENT C

Sr.No	Candidates Name	Mob.No.	Session-I Sign.	Session-II Sign.
1	Pawar Pranita-A	9119405887		
2	Patil Shruti R	9172370019		
3	Shete Shravani H	7219897004		
4	Patil Aditya	921621002		
5	Ningadale snehal kalyansan	7387744886		
6				
7				
8				
9				
10				
11				
12				
13				
14				
15				
16				
17				
18				
19				
20				
21				
22				
23				
24				
25				

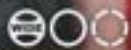

Shot on Y15
Vivo AI camera

FEUL, Pune

2020.03.03 12:05

2 Language and Communication Skills



13

G. K. Gujar Memorial Charitable Trust's
Dr. Ashok Gujar Technical Institute's
Dr. Daulatrao Aher College of Engineering, Karad
Accredited by NAAC with B+ & ISO 9001-2008 Certified Institute
Training & Placement Cell

DACOE/ TPO/2022-2023/

Date: 25/11/2022

Group Discussion Session Notice-2023

All the Students of B. Tech- CSE, ENTC, MECH & CIVIL 2023 are hereby informed to note that, **Group Discussion Session** by Mr. P. D. Bansode, TPO is scheduled on **26/11/2022 at 11:00 am at Auditorium**

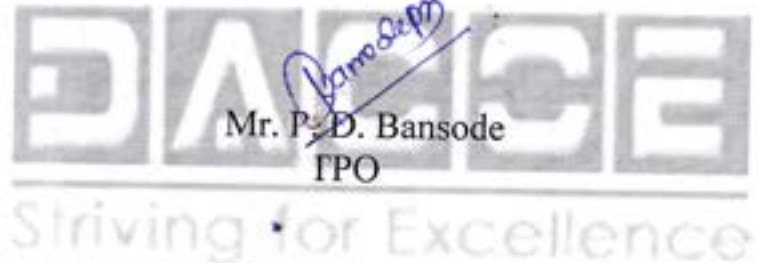

Cc:

HOD - EXTC		HOD - CSE	
HOD- MECH		HOD- CIVIL	
TPC-ENTC		TPC-CSE	
TPC-CIVIL		TPC-MECH	



Prof. P.D. Bansode

GPS Map Camera

Karad, Maharashtra, India

Vidyanagar Extn. Banawadi, Satara, Karad, Maharashtra 415124, India

Lat 17.315535° Long 74.195374°

21/04/22 10:51 AM

AGTI's Dr. Daulatrao Aher College Engg. Karad

 34.88° C

 287° W

 37.0 μ T

3 Life Skills



G.K. Gujar Memorial Charitable Trust's
Dr. Ashok Gujar Technical Institute's,
Dr. Daulatrao Aher College of Engineering, Karad.

Vidyanagar Ext. Banawadi, Tal. Karad 415124, Dist. Satara, Maharashtra INDIA

Date: 06/03/2023

NOTICE

All **GIRLS** students are hereby inform that, We will arrange Counselling session "**Leady Care**" on 8/3/2023 at time 12.00PM on the occasion of International Womens day. so all girls student should be attend Counselling session as mentioned schedule. attendance is mandatory to all girl students.

Venue: CR-95

Co-Ordinator

Dr.A.M.Zende (HOD)



G.K. Guiar Memorial Charitable Trust's
Dr. Ashok Guiar Technical Institute's.
Dr. Daulatrao Aher College of Engineering, Karad.
Vidyanagar Ext. Banawadi, Tal. Karad 415124, Dist. Satara, Maharashtra INDIA

Girls counseling Session: LEADY CARE
INTERNATIONAL WOMENS DAY

ATTENDANCESHEET

Sr.No.	Name Of Candidate	Sign
1	Dubal Vaishnvi.	
2	Gaikwad Sharvari	
3	Gauri kadam	
4	Simran Mulani	
5	Nadaf Muskan	
6	Waghmare Ankita	
7	Nalwale vrushali	
8	Thorat Nehal	
9	Sumudhi Thorat	
10	Sonal Lade	
11	Shreya V. Rajput	
12	Salunkhe pradnya	
13	Anjugade Prachi	
14	Shewali Samriddhi	
15	Aaiman Iransdar	
16	Bejakta Shinde	
17	Ashwini Waghmare	
18	Shubha Shrawa	
19	Tejaswini Jujor	



G.K. Guiar Memorial Charitable Trust's
Dr. Ashok Guiar Technical Institute's.
Dr. Daulatrao Aher College of Engineering, Karad.
Vidyanagar Ext. Banawadi, Tal. Karad 415124, Dist. Satara, Maharashtra INDIA

Girls counseling Session: LEADY CARE
INTERNATIONAL WOMENS DAY

ATTENDANCESHEET

20	Mulla Rafiya	Mulla
21	Bhasme Athwarya	Bhasme
22	Dhinghe Prachi	Prachi
23	Rutuja Chavan	Rutuja

Co-ordinator







अहवाल

दि.२२/०६/२०२३

दिनांक 21 जून हा आंतरराष्ट्रीय योगा दिन साजरा केला जातो. या दिनाचे औचित साधुन आमच्या महाविध्यालयात योगा दिन साजरा करण्यात आला या कार्यक्रमासाठी प्रमुख पाहुणे म्हणून निलम पाटील मॅडम व प्रा . स्मिता जानुगडे उपस्थित होत्या. त्यांचे स्वागत प्राचार्य डॉ.अन्वर मुल्ला यांनी केले. त्यावेळी उपप्राचार्य प्रा .हणमंत कुंभार फिजिकल डायरेक्टर व राष्ट्रीय सेवा योजना कार्यक्रम अधिकारी प्रा. अयुब कच्छी सर तसेच कल्चर प्रमुख प्रा. अर्चना रेणूसे प्रा.सोनाली वांगीकर प्रा.अश्विनी शेलार इतर माझे सहकारी व विध्यार्थी विध्यार्थीनी उपस्थित होते. निलम पाटील मॅडम व प्रा . स्मिता जानुगडे यांनी योगाची प्रात्यक्षिके घेतली.या कार्यक्रमास पन्नास विध्यार्थी विध्यार्थीनी उपस्थित होते. व त्या नंतर आभार मानण्यात आले व हा कार्यक्रम संपला.



आपला विश्वासू



**G. K. GUJAR MEMORIAL CHARITABLE TRUST'S
DR. ASHOK GUJAR TECHNICAL INSTITUTES
DR. DAULATRAO AHER COLLEGE OF ENGINEERING, KARAD**

Attendance sheet for “Yoga Day”

Sr. No	Name
1	GhatageSuyash Ranjitsinh
2	Ghodke Dhanraj Dilip
3	HattigotePrerana Shivaji
4	Ingavale Priya Shivaji
5	Ingavale Rupali Mahadev
6	Jadhav AratiBhiku
7	Jadhav Bhakati Raghunath
8	Jadhav Pooja Balkrishna
9	Jadhav Shivendrasinh M.
10	Kale AmeyAnnaso
11	KADAM ROHAN SANJAY
12	KADAM SHREYA SAYAJI
13	KATARE PALLAVI KUNDLIK
14	KESARE RUTUJA SANJAY
15	KHANDAGALE DHANSHRI CHHAGAN
16	KOKARE SHRADDHA SANTOSH
17	KOLI RUTUJA ANIL
18	KSHIRSAGAR VAISHNAVI MACHINDRANATH
19	KULKARNI RUTVIK SANJAY
20	KUMBHAR AJINKYA VIJAY
21	KUMBHAR AKASH SANTOSH
22	KUMBHAR POOJA UDAY

23	KUMBHAR PRAJKTA KAMALAKAR
24	KUMBHAR ROHINI PRAKASH
25	MANE HRUSHIKESH SURYAKANT
26	MANE RADHIKA RAJENDRA
27	MANE SAI VIJAY
28	MORE KARAN ABASAHEB
29	MORE PRITI VIKAS
30	MULLA DAUD SHABBIR
31	MULLA MUSKAN TAYYABALI
32	MULLA SWALIHA HAROON
33	PATIL SAURABH BHUJANGRAO
34	PAWAR AMRUTA VIKAS
35	PATIL ADITYA VISHWAS
36	KAMBLE ANKITA RAJARAM
37	MULLA SALINA SAMEER
38	BHALDAR AJIMA RAFIK
39	KAMBLE VINAY SUNIL
40	YADAV UTKARSH SUNIL

Photo of "Yoga Day"



4 ICT/ Computing Skills

**One Week
Short Term Training Programme
On
“CATIA Essentials”
(11th Oct. to 20th Oct. 2022)**

Registration Form

1. Full Name (in Block Letters):.....
.....
2. Designation:.....
3. Organisation Address:.....
.....
.....
4. Contact No:.....
- 5.E-mail Id:.....
.....
6. Registration Details:
DD No./Cash.....
Date Withdrawn.....
Name of Bank.....
.....
7. Accommodation Required: YES/NO

Applicant's
Signature

Signature of Authority
with Seal

REGISTRATION FEES:

UG/PG Student Participant =1500/- INR
Faculty Participant =2000/- INR
Industry Participant=3000/-INR

Note:

No TA DA will be provided to the participants for attending the course. Limited accommodation available on payment basis.

IMPORTANT DATES:

Last Date of Registration: 10th Oct. 2022
Date of Confirmation: 11th Oct. 2022.

DATE AND VENUE:

The Short Term Training Programme will be held during **10-20th Oct., 2022** at Computer lab, Mechanical Engineering Department, Dr. Daulatrao Aher College of Engineering, Karad.

ADDRESS TO COMMUNICATIONS:

Prof. Vinayak D. Yadav
Co-ordinator,
Department of Mechanical Engineering
AGTI's Dr. Daulatrao Aher College of Engineering,
Vidyanagar Extn. Banawadi,
415124, Karad, Dist: Satara, Maharashtra, INDIA
Phone: (02164) 272701/02; Fax: (02164) 272703



G.K. Gujar Memorial Charitable Trust's
Dr. Ashok Gujar Technical Institute's
**DR. DAULATRAO AHER COLLEGE OF
ENGINEERING, KARAD**



**One Week Short Term Training
Programme on
“CATIA Essentials”**

(11th Oct. to 20th Oct. 2022)

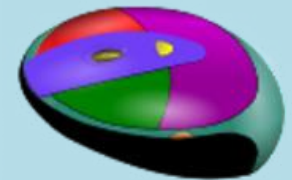
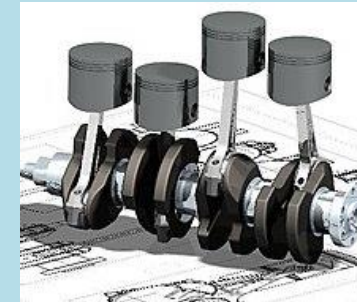

**Organized by,
Department of Mechanical Engineering,
Dr. Daulatrao Aher College of Engineering,
Vidyanagar Extension,
Banwadi, Karad, Maharashtra, India**

ABOUT INSTITUTION:

Dr. Daulatrao Aher College of Engineering, Karad was established in 2008 by Dr. Ashok G. Gujar, as part of Shri G. K. Gujar Memorial Charitable Trust's activities at Karad. The Institute is approved by the All India Council for Technical Education (AICTE) New Delhi, Directorate of Technical Education (DTE) Mumbai and Government of Maharashtra and is affiliated to Shivaji University Kolhapur. The Institute offers Undergraduate Engineering Programs in Mechanical Engineering, Electronics & Telecommunication Engineering, Civil Engineering and Computer Science & Engineering leading to B.E. Degree as per Shivaji University Curriculum.

ABOUT DEPARTMENT:

Mechanical Engineering Department was established in the year 2008. The Department has a team of highly qualified and experienced faculty. Research activities at the department are progressing in the areas of feature based design, design optimization of Mechanical systems, Flexible Mechanisms, alternative fuels for IC engines, thermal energy storage and material technology. Mechanical Engineering envisaged the development, design, manufacturing and maintenance of machinery. The present age demands Mechanical Engineering specialists who have the capacity of adaptability and creativity in the new technical areas. Mechanical engineers should have knowledge not only in their own specialized fields but also in wide inter disciplinary fields as well to meet the above requirements.

HOW TO APPLY:

Interested participants are requested to send, filled and duly signed Registration form along with Demand Draft of course fees as applicable in favor of "MECH AGTI DACOE" payable at Karad. to the said address. This fee will cover refreshment. **There are only limited no of participants for the course on first come first serve basis.**

CHIEF PATRONS

Hon. Dr. Ashok G. Gujar

Chairman, G. K. Gujar Memorial Charitable Trust, Karad

Shri. Indrajit A. Gujar

Vice Chairman, G. K. Gujar Memorial Charitable Trust, Karad

Dr. Madhuri I. Gujar

Secretary, Dr. Daulatrao Aher College of Engineering, Karad

PATRON

Dr. Anwar M. Mulla

Principal, Dr. Daulatrao Aher College of Engineering, Karad (Maharashtra)

Prof. Hanmant M. Kumbhar

Vice Principal, Dr. Daulatrao Aher College of Engineering, Karad (Maharashtra)

CONVENER

Prof. Sarafraj J. Mulani

Head, Department of Mechanical Engineering
Mb. 9922813970

E-mail: hodmechanical@dacoe.ac.in

CO-CONVENER

Prof. Hemant K. Shete-Mb. 9420696944
Department of Mechanical Engineering

COURSE COORDINATORS

Prof. Vinayak D. Yadav -Mb.9766532789

Prof. Prashant P. Bhise-Mb. 9766286956

Prof. Pradip S. Gunwant-Mb. 9975575667

Department of Mechanical Engineering,
E-mail: vdyadav.mech@dacoe.ac.in

ORGANIZING COMMITTEE

Dr. V.M.Jamadar Mr. V.V.Rangate Mr.S.D.Bagade

Mr. P. S. Mohite Mr.A.D.Awasare Mr. R.R. Chavan

Miss.S.V.Janugade Mrs.A.B. Shelar Mrs. S.A.Budhe

ABOUT PLC-SCADA:

Computer Aided Design is extensively used in the design of tools and machinery used in the manufacture of components and Design courses like CATIA, CREO, NX etc. has wide range of application in the industry, Department of Mechanical Engineering arranged vocational training of these courses for the third year and final year students. CATIA Essentials covers the fundamentals of CATIA and is the foundation on which we can build our modeling skills Part Modeling and Assembly Modeling will complete our knowledge of solids modeling tools and techniques. Also complex or organic shapes, Advanced Surfacing Modeling will be introduced

COURSE OBJECTIVES:

- Demonstrate competency with multiple drawing and modification commands in CATIA.
- Create three-dimensional solid models.
- Create three-dimensional assemblies incorporating multiple solid models.
- Preparation of technical mechanical drawings.

COURSE CONTENT:

- Introduction to CAD, CAE, PDM Features of CATIA,
- SKETCHER
- Sketch Tools -
- PART MODELING
- Creating Loft features, Creating curves -
- Creating Chamfer Creating Shell Creating Rib
- Inserting Fastening features- Mounting boss, snap hook
- ASSEMBLY MODELING
- Applying Advanced Mates ,Manipulating Components -
- SURFACE MODELING

RESOURCE PERSONS:

Experienced faculties from reputed institutions and professional trainers from Design Solutions Karad



G.K. Gujar Memorial Charitable Trust's

Dr. Ashok Gujar Technical Institute's,
Dr. Daulatrao Aher College of Engineering, Karad.
Vidyanagar Ext. Banawadi, Tal. Karad 415124, Dist. Satara, Maharashtra INDIA

Department of Mechanical Engineering

CATIA Essentials TRAINING ATTENDANCE

Sr. No	Name of Student	Date: 11/10	12/10	13/10	14/10	15/10	17/10	18/10	19/10
1	Inamdar Sujit Dattatray	P	P	P	P	A	P	P	P
2	Kurkute Digvijay D	P	P	A	P	P	P	P	P
3	Jamdar Sarang S.	P	P	P	P	P	P	P	P
4	Ramdasi Anuj H.	P	A	P	P	P	P	P	P
5	Yadav Prasad P.	P	P	A	P	A	P	P	P
6	Shinde Rushikesh S.	P	P	A	P	A	P	P	P
7	Raies javed Shikalgar	P	A	P	A	P	P	P	A
8	Rutik Kundlik Dolare	P	A	A	P	P	P	P	P
9	Avinash M. Deshmukh	P	P	P	P	P	P	P	P
10	Desai Shubham N.	A	P	P	P	P	P	P	P
11	Sathe Sanket Adhikrao	P	A	P	P	P	P	P	A
12	Lagade Priti Anna	P	P	P	P	P	A	P	P
13	Azruddin S. Attar	P	P	P	P	P	P	P	P
14	Muskan A. Mulani	P	P	P	P	P	P	P	P
15	Pawar Prashant N.	P	A	A	P	P	P	P	P
16	Dhumal Akash A.	P	P	P	A	A	P	P	P
17	Maske Rajesh B.	P	P	P	P	P	P	P	P
18	Shirwadkar Sahil P.	P	P	P	P	P	A	P	P
19	Akansha S. Pol	P	P	P	P	A	P	P	P

20	Shah Yash P.	P	P	P	P	A	A	P	P
21	Desai Atharv S.	A	P	P	A	P	P	P	P
22	Waghmare Viki S.	P	P	P	A	P	P	P	P



Mr. V. D. Yadav
Coordinator

Mue-S.J.

Head of Mechanical Engg. Deptt.
Dr. Dautatrao Aher College of Engineering
Banawadi-Karad.

Mr. S. J. Mulani
HOD MECH





G. K. Gujar Memorial Charitable Trust's
Dr. Ashok Gujar Technical Institute's
Dr. Daulatrao Aher College of Engineering, Karad
Accredited by NAAC with B+ & ISO 9001-2008 Certified Institute
Training & Placement Cell

AGTI's /DACOE/ TPO/2021-2022/07

Date: 15/11/2022

Notice

All the B.Tech. Students of all branches are hereby informed to note that, "A **Session On Latest Technologies**" by Tata Group is arranged on 16/11/2022 at 11:00 am at auditorium.

All the students are requested to attend the session.

Name of the Spicer: Mr. Dr. Rushikesh Kulkarni Sir

Faculty Coordinator : Mr. S. P. Chavan Sir (CIVIL. DEPT.)

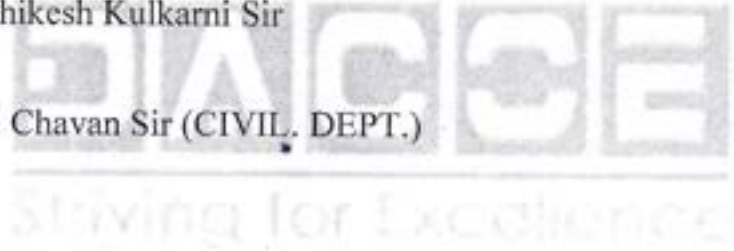

Mr. P. D. Bansode
Training & Placement Officer

Essentials of Industrial Robotics

2 Weeks Course

Week 1 Online - Virtual training with FANUC ROBOGUIDE
4 hours/day
Online + Instructor

Week 2 Practicals - 3 days at FANUC academy
8 hours/day
in lab with instructor

Week 3 and 4 - Support along with access to the FANUC ROBOGUIDE
4 hours/week
Online + Instructor

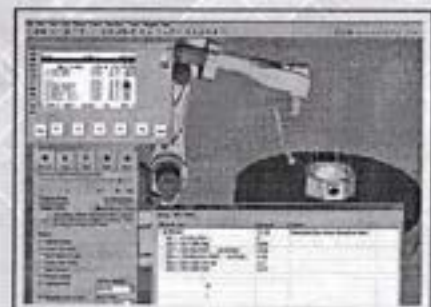

Week 1 - Online : Virtual training with FANUC ROBOGUIDE 4 hours/day, Online + Instructor

- ▶ Introduction to industrial ROBOT and virtual simulation tool (ROBOGUIDE)
- ▶ Teach pendant introduction
- ▶ Jogging of ROBOT - choosing the co-ordinate system
- ▶ Essentials of programming Explanation on motion instruction
- ▶ Editing of program Adding various tools & TCP concept
- ▶ Concept of a cell layout
- ▶ Adding and editing the obstacles
- ▶ Pick and place of the component
- ▶ Capturing video of simulation

Week 2 - Practicals : 3 days at FANUC academy 8 hours /day (in lab with instructor)

- ▶ Introduction to various models and its selection criteria
- ▶ Jogging of ROBOT in joint / world frame
- ▶ Selection and creation of teach program
- ▶ Explanation on Joint, linear and circular motion
- ▶ Setting and usage of tool frames
- ▶ Usage of various program control instructions
- ▶ Introduction to I/O and I/O instructions
- ▶ Palletizing instruction
- ▶ Parts of robot controller
- ▶ Robot controller block diagram
- ▶ Mechanical unit - simple maintenance
- ▶ Tech centre and repair centre visit

Week 3 and 4 -Online Support 4 hours/week, Online + Instructor

- ▶ Support along with access to FANUC ROBOGUIDE
- ▶ EXTRA TOPICS
 - ▷ Essentials of Quality
 - ▷ Industrial safety
 - ▷ Essentials of metrology and GD&T
 - ▷ Lectures from Industry experts on Industry 4.0
 - ▷ Other related topics



COURSE INCLUDES:

- Simulation software access for course duration
- Course Material Certificate of completion

CONTACT DETAILS:

Dr. Rushikesh Kulkarni
✉ rushikesh.kulkarni@tataiis.org
Mr. C. Ashwath
✉ ashwath.c@tataiis.org

COURSE FEE:

For industry candidates:
Rs. 15000/- & above
(including taxes)
For students (special pricing):
Rs. 1000/- (including taxes)

TPC - ETC & MECH, kindly submit the number of students interested for this course by today upto 5:00 pm Rs. 3000/-

BSK John
24/11/22

11/16

VDY John
man.

AGTI's Dr. Daulatrao Aher College
of Engineering Karad.

Date
16/11/2022
Time
2:30 pm

A session on latest Technologies
by Dr. Rushikesh Kulkarni
Training manager TATA group

So. No.	Name	Branch	Sign
1.	Rohan S. Thombare	MECH	<u>R.T.</u>
2.	Viki Suresh Waghmare	Mech	<u>Sw</u>
3.	Patel Shoyab Altaf	Mech	<u>S. Patel</u>
4.	Bagwan Soheb Jabbar	Mech	<u>S. J. Bagwan</u>
5.	Patel Aavej Vahid	Mech	<u>APV</u>
6.	Patil Sangram maruti	mech	<u>Amant</u>
7.	Dingane Omkar Shivaji	Mech	<u>OD</u>
8.	Jadhav Jaydip Ganesh	mech	<u>Jaydip</u>
9.	More Pratik Satish	Mech	<u>More</u>
10.	Deshmane Sankat Dilip	mech	<u>Sankat</u>
11.	Kalburgi Shivam Balkrishna	Mech	<u>Sw</u>
12.	Thotat Shubham shivaji	Mech	<u>Thotat</u>
13.	Pod shivam Rajendra	Mech	<u>Pod</u>
14.	Sankpal Sunil Rajendra	mech	<u>Sankpal</u>
15.	Kumbhar Avishkar Santosh	Mech	<u>Sw</u>
16.	Shinde Rushikesh Subas	Mech	<u>Sw</u>
17.	Yadav Prasad Prakash	Mech	<u>Sw</u>
18.	Karan Ashok Desai	ENTC	<u>Sw</u>
19.	Aditya Vishwas Patil	ENTC	<u>Aditya</u>
20.	Chavan Aniket A.	EGTC	<u>Chavan</u>
21.	Patil Saurabh B.	EGTC	<u>Patil</u>
22.	Power Prashant Nivesh	Mech	<u>Power</u>
23.	Ramdas Anuj Hemant	Mech	<u>AHRamdas</u>
24.	Shah Yash Prashant	Mech	<u>Sw</u>
25.	Jamdar Sarang Sushilkumar	Mech	<u>Sw</u>

Sr.No.	Name	Branch	Sign?
26)	Digvijay Digambar Kulkute.	Mech	<u>Date</u>
27)	Attharv Surendra Desai	Mech	<u>Desai</u>
28)	Attharv Rajendra Keluskar	Mech	<u>##</u>
29)	Aditya Dilip Kumble	Mech	<u>Aditya</u>
30)	Muskan Abdul Mulani	Mech	<u>Muskan</u>
31)	Rasika Tate	Mech	<u>Rasika</u>
32)	Romsha Jadhav	Mech	Romsha
32)	Romsha Jadhav	Mech	<u>Romsha</u>
33)	Ruchik Lad	Mech	<u>Ruchik</u>
34)	Mulla Benir	Mech	<u>Mulla</u>
35)	Pol Akanksha	Mech	<u>Akanksha</u>
36)	Patel Aashiya	Mech	<u>Patel</u>
37)	Lagade Prihi	Mech	<u>Prihi</u>
38)	Sonawale Sonali	Mech	<u>Sonali</u>
39)	Rutuja Autade	ENTC	<u>Rutuja</u>

Dr. Rushikesh Kulkarni



GPS Map Camera

Karad, Maharashtra, India

Vidyanagar Extn. Banawadi, 858W+745, Satara, Karad, Maharashtra 415124, India

Lat 17.31561° Long 74.1953°

06/04/23 11:39 AM GMT +05:30

AGTI's Dr. Daulatrao Aher College Engg. Karad



35.2° C



13° N



35.0 μ T



21
12

G. K. Gujar Memorial Charitable Trust's
Dr. Ashok Gujar Technical Institute's
Dr. Daulatrao Aher College of Engineering, Karad
Accredited by NAAC with **A+** & ISO 9001-2008 Certified Institute
Training & Placement Cell

DACOE/ TPO/2022-2023/

Date 06/01/2023

Training Notice for TY & B. Tech. All Branches

All the TY. B. Tech & B. Tech. all branches are hereby informed to note that, **Technical C, C++, Python, Soft Skills & Aptitude Training** is scheduled as per following schedule. All the students should attend the Training, as this Training is very much crucial for Placement drive preparation.

Sr.No.	Name of the Training	Duration & Time	Class & Branch	Batch	Venue
1	Technical Training C, C++ & Python By GTT, Pune	30 th Jan. To 1 st Feb. 2023 9:30 to 5:00	TY- CSE & ENTC TY & B.Tech- Civil & MECH	A C	Class Room & Labs C R
2	Technical Training C, C++ & Python By GTT, Pune	30 th Jan. To 1 st Feb. 2023 9:30 to 5:00	B.Tech.- CSE & ENTC	B	Class Room & Labs
3	Soft Skills – Employability Skills 24 hrs By Rubicon, Pune	2 nd Feb. to 4 th Feb. 2023 9:30 to 5:00	TY- CSE & ENTC B.Tech.- CSE & ENTC TY- MECH & CIVIL B.Tech.- MECH & CIVIL	A B C D	Class Rooms
4	Aptitude Training 24 hrs By FUEL, Pune	6 th Feb. to 8 th Feb. 2023 9:30 to 5:00	TY- CSE, ENTC, MECH & CIVIL	A	Auditorium
5	Aptitude Training 24 hrs By FUEL, Pune	9 th Feb. to 11 th Feb. 2023 9:30 to 5:00	B. Tech.- CSE, ENTC, MECH & CIVIL	B	Auditorium

Prof. H. M. Kumbhar
Vice-Principal

Dr. Anwar M. Mulla
Principal

Cc:

Dean- Academic		TPO	
HOD - EXTC		HOD - CSE	
HOD- MECH		HOD- CIVIL	
TPC-ENTC		TPC-CSE	
TPC-CIVIL		TPC-MECH	

Dean



Dr. Ashok Gujar Technical Institute's
Dr. Daulatrao Aher College of Engineering, Karad
Technical Training by- GTT, Pune

21

Date : 30/01/2023 to 01/02/2023 Venue: CR

Time: 9:30 am to 5: 30 pm

Date: 30/01/2023

Class: T.Y. B.Tech Mechanical. Branch: Mechanical

Sr.No	Candidates Name	Mob.No.	Session-I Sign.	Session-II Sign.
1	APHALE HIMANSHU DEVBHUSHAN	7588333162	<i>Apahale</i>	<i>Apahale</i>
2	KUMBHAR AVISHKAR SANTOSH	7057831609	<i>AKK</i>	
3	DINGANE OMKAR SHIVAJI	8830444197	<i>DD</i>	
4	DESAI SHIVAM ASHOK	8432196358	<i>Desai</i>	
5	JAMALE TUSHAR NATHURAM	9370518219	<i>Jale</i>	
6	PAWAR ABHISHEK SHASHIKANT	9579352526	<i>Pawar</i>	<i>Pawar</i>
7	BOBADE MAHESH SADASHIV.	9579060048	<i>MAD</i>	<i>MAD</i>
8	VELHAL RUTVIK SUNIL	9156992957	<i>RVelhal</i>	<i>RVelhal</i>
9	SAWANT SAIRAJ SURESH	7387741999	<i>Sawant</i>	
10	KAMBOLE ADITYA	9922069759	<i>AK</i>	
11	KOKARE VISHWAJIT	9284387067	<i>AKKOKAR</i>	
12	PATIL INDRAJEET SATISH	8805308080	<i>Patil</i>	
13	NIKAM RUSHIKESH KULDIP	9284212241	<i>Nikam</i>	
14	JADHAV BALWANT ANANDA	8530115806	<i>Jadhav</i>	<i>Jadhav</i>
15				
16				
17				
18				
19				
20				
21				
22				
23				
24				
25				

Sr.No	Candidates Name	Mob.No.	Session-I Sign.	Session-II Sign.
26				
27				
28				
29				
30				
31				
32				
33				
34				
35				
36				
37				
38				
39				
40				
41				
42				
43				
44				
45				
46				
47				
48				
49				
50				
51				
52				
53				
54				
55				

Name & Sign. of TPC with Date.



Dr. Ashok Gujar Technical Institute's
Dr. Daulatrao Aher College of Engineering, Karad
Technical Training by- GTT, Pune

Date : 30/01/2023 to 01/02/2023 Venue: CR

Time: 9:30 am to 5: 30 pm

Date: 30/01/23

Class: B.Tech

Branch: CSE

Sr.No	Candidates Name	Mob.No.	Session-I Sign.	Session-II Sign.
P 1	Karan More	7038936357		
2	Nikom Shubhankar	9225831193		
3	Omkar Pawar.	7058076931		
P 4	Vishvajit D. Simgawanshi	9579816391		
P5	Dauid mulla	7558706011		
P6	Sohan Dhunaji Suter.	9767160932		
7	Siddesh Panjabrao Bhandare	8999346264		
P8	Parth Vivek Gaswase	9527328167		
P 9	Omkar Sawant	9561214133		
10	Rohit Dange	8485875277		
P11	Shreya Jadhav	7620484340		
P12	Kesare Rutuja Sanjay	7387919813		
P13	Snehal Patil	4665723402		
P14	Manali Potdar	7350382359		
P 15	Toupti Patil	8698823161		
16	Maithili Tirmore	9067373396		
17	Salunkhe Rucha Sandesh	8010821614		
P18	Priti More	7028506092		
P19	Dipti patil	8698923160		
P20	Dhanshi Khandagale	7249674690		
P21	Prajakta Kumbhar	9307362504		
P22	Mayuri Chavan	8554935834		
P23	Mayuri Yadav	7420841756		
P24	Mulla Muskan	9175658899		
P25	Pratiksha Patil	9022607510		

Sr.No	Candidates Name	Mob.No.	Session-I Sign.	Session-II Sign.
26	Kadom Kajal	9850130244	K.C.Kadom	
27	Shinde Rutuja	7709788265	R.Shinde	
28	Sawant Ekta	8668332704	Ekta	
29	Gurav Bhagyashree	8459991695	Bhagyashree	
P 30	Yadav Samiksha	9504774747	S.Yadav	S.Yadav
P 31	Pawar Aishwarya	9021031086	A.P.Pawar	A.P.Pawar
32	Yedage Dhonashree	7767910492	D.Yedage	
33	Bondre Isha	7387790443	I.Bondre	
34	Chorage Protik	8010719163	P.Chorage	
35	Omkar Kotu	9763953178	O.Kotu	
36	Vipul Yadav	9763492600	V.Yadav	V.Yadav
37	Ashwin Patil	8412017271	A.Patil	A.Patil
P 38	Kadom Rohan	9503217630	R.Kadom	R.Kadom
P 39	Pragati Patil	9834151913	P.Patil	P.Patil
P 40	Namrata Shinde	7774927171	N.Shinde	N.Shinde
P 41	Harshada Tapase	9595111395	H.Tapase	H.Tapase
42	Snehal Kalyansob Ningadale	7387744886	S.K.Ningadale	S.K.Ningadale
P 43	Vedanti Mukund Gore	9322468296	V.Gore	V.Gore
P 44	Kshirsagar Vaishnavi Machindranath	8857087056	V.Vaishnavi	V.Vaishnavi
45	Siddhant Horne	9604004773	S.Horne	S.Horne
46				
47				
48				
49				
50				
51				
52				
53				
54				
55				

Name & Sign. of TPC with Date.



Dr. Ashok Gujar Technical Institute's
Dr. Daulatrao Aher College of Engineering, Karad
Technical Training by- GTT, Pune

Date : 30/01/2023 to 01/02/2023 Venue: CR

Time: 9:30 am to 5: 30 pm

Date: 30-1-2023

Class: TE

Branch: CSE

Sr.No	Candidates Name	Mob.No.	Session-I Sign.	Session-II Sign.
1	Omkar Pakhale	8530524197		
P 2	Gaurav Mohite	9021354203		
3	Prashant Chavan	7410598085		
4	Shubham Chavan	9107171117		
5	Katu Omkar Baban	9763958178		
6	Rohan Desai	8668530077		
7	Vishal Patil	9730220101		
8	Rizwan Mujawar	9975919156		
9	Kalaskar Abhishek	9850073968		
10	Sanket Mane	9359006510		
P 11	Suyash Patil	7066813773		
12	Omkar Kodulkar	7517752204		
P 13	Snehal Jadhav	7264088042		
P 14	Mukti Mahajan	9373946505		
P 15	Diya Inamdar	7709102458		
P 16	Archana Shejwal	8485856454		
17	Nidhish Moolya	9370217137		
18	Glenn Couto	7774970731		
P 19	Saad Mujawar	7391942667		
P 20	Prathmesh Kumbhar	9561841929		
21	Rucha Sanderh Salunkhe	8010821614		
22	mulla suhan Jameer	9975488562		
23	Patil peandali sanday	9423453023		
24	Patil sheeya dadao	9021102310		
P 25	Godale snehal Krishna	7757809415		

Sr.No	Candidates Name	Mob.No.	Session-I Sign.	Session-II Sign.
P 26	Pawar Dhanashri Nitin	9022449491	<u>Pawar</u>	<u>Pawar</u>
P 27	Vetal Shivanjali Ramrao	801018088	<u>Vetal</u>	<u>Vetal</u>
P 28	Karale Aakanksha Chandrakant	9075105104	<u>Karale</u>	<u>Karale</u>
29	Pooja Babaso Kamble	9325091466	<u>Pooja</u>	<u>Pooja</u>
P 30	Shinde Sanika Sanjay.	9356107975	<u>Sanika</u>	<u>Sanika</u>
P 31	Shedage Gauri Dhanaji	8550987006	<u>Shedage</u>	<u>Shedage</u>
P 32	Chorage Pratik	8010719163	<u>Chorage</u>	<u>Chorage</u>
33	Omkar Katu	9763953178	<u>Omkar</u>	
P 34	Soyama Mujawat	7720044636	<u>Soyama</u>	<u>Soyama</u>
P 35	Sakshi Kadam	7020541437	<u>Sakshi</u>	<u>Sakshi</u>
P 36	Sanika Nalawade	9322766875	<u>Sanika</u>	<u>Sanika</u>
P 37	Prathmesh Kumbhar	9561841920	<u>Prathmesh</u>	<u>Prathmesh</u>
P 38	Veraj Kadam	8975779161	<u>Veraj</u>	<u>Veraj</u>
39				
40				
41				
42				
43				
44				
45				
46				
47				
48				
49				
50				
51				
52				
53				
54				
55				

Name & Sign. of TPC with Date.



Dr. Ashok Gujar Technical Institute's
Dr. Daulatrao Aher College of Engineering, Karad
Technical Training by- GTT, Pune

Date : 30/01/2023 to 01/02/2023 Venue: CR

Time: 9:30 am to 5: 30 pm

Date: 30/01/23

Class: B.Tech

Branch: ENTC

Sr.No	Candidates Name	Mob.No.	Session-I Sign.	Session-II Sign.
1	Adash Dipak Bhise	7666863025	<u>Bhise</u>	<u>Bhise</u>
2	JAYDEEP NATHAN Kadam	89 83029678	<u>Jaydeep</u>	<u>Jaydeep</u>
3	Jadhav Viswajit + Muralidhar	9350003973	<u>viswajit</u>	<u>viswajit</u>
4	Ratnashambhura j chandrakar	7249384095	<u>(Ratn)</u>	<u>(Ratn)</u>
5	Shete Shravani Hemant	7219897004	<u>shete</u>	<u>shete</u>
6	Kadam Dhanashri Mahadev	9359807948	<u>Dkadam</u>	<u>Dkadam</u>
7	Jadhav Nikita Bhagwan	8378894288	<u>N.Jadhav</u>	<u>N.Jadhav</u>
8	Chavan Pratiksha Ratnakar	9730327563	<u>Prachan</u>	<u>Prachan</u>
9	Shinde Shradha Dattatray	9665149606	<u>shinde</u>	<u>shinde</u>
10	mane vday sudhir	9839961557	<u>mane</u>	<u>mane</u>
11	Ningadale snehal kalyan	7387744880	<u>S.k.Ningadale</u>	<u>S.k.Ningadale</u>
12				
13				
14				
15				
16				
17				
18				
19				
20				
21				
22				
23				
24				
25				

Sr.No	Candidates Name	Mob.No.	Session-I Sign.	Session-II Sign.
26				
27				
28				
29				
30				
31				
32				
33				
34				
35				
36				
37				
38				
39				
40				
41				
42				
43				
44				
45				
46				
47				
48				
49				
50				
51				
52				
53				
54				
55				

Name & Sign. of TPC with Date.



Dr. Ashok Gujar Technical Institute's

Dr. Daulatrao Aher College of Engineering, Karad

Technical Training by- GTT, Pune

Date : 30/01/2023 to 01/02/2023 Venue: CR

Time: 9:30 am to 5: 30 pm

Date: 30/01/23

Class: TE

Branch: ENTC

Sr.No	Candidates Name	Mob.No.	Session-I Sign.	Session-II Sign.
1	Kazi Ayan Nasir	8698824640	<u>AKazi</u>	
2	Phalle Bhagavant Anil	9970698840	<u>BPhalle</u>	
3	Magdum Swapnali Vilas	7083796588	<u>Magdum</u>	
4	Mane Shweta Sunil	9325285441	<u>Shweta</u>	
5	Patil Rutuja Dilip	7020558900	<u>Patil</u>	
6	Patel Afsana Rashid	9689235307	<u>Patel</u>	
7	Shetty Gowtami Avinash	9623140669	<u>Shetty</u>	
8	D'souza Venissa Prakash	7058286016	<u>D'souza</u>	
9	Mane Vaishnavi Jeevan	7558663262	<u>Mane</u>	
10				
11				
12				
13				
14				
15				
16				
17				
18				
19				
20				
21				
22				
23				
24				
25				

Sr.No	Candidates Name	Mob.No.	Session-I Sign.	Session-II Sign.
26				
27				
28				
29				
30				
31				
32				
33				
34				
35				
36				
37				
38				
39				
40				
41				
42				
43				
44				
45				
46				
47				
48				
49				
50				
51				
52				
53				
54				
55				

Name & Sign. of TPC with Date.



Dr. Ashok Gujar Technical Institute's

Dr. Daulatrao Aher College of Engineering, Karad

Technical Training by- GTT, Pune

Date : 30/01/2023 to 01/02/2023 Venue: CR

Time: 9:30 am to 5: 30 pm

Date: 31/01/2023

Class: T.Y.

Branch: CSE

Sr.No	Candidates Name	Mob.No.	Session-I Sign.	Session-II Sign.
1	Gauxav Mohite	9021354203		
2	Chorage Pratik	8010719163		
3	Veraji Mohodik	8975779161		
4	Pawar Dhanashri	9022449491		
5	Gadale Snehal	7757809415		
6	Shinde Sanika Sanjay	9356107975		
7	mulla suhan Jameez	9975488562		
8	Patil Peandali sanday	9423453023		
9	Patil Shreya Daclawo	9021102316		
10	Kamble Pooja Babasaheb	9325091466		
11	Patil Vaishnavi Ashok	7498409291		
12	Mujawar Sayama Dilawar	7720044636		
13	Shirsat Salonee Pravin	9834710741		
14	Patil Saylee Sanjay	9766652699		
15	Yadav Pratiksha Balasaheb	97028720289		
16	Manasi Mahesh Lawand.	7058584833		
17	Vaishali Varantha Poojary	9588650699		
18	Neha Ganesh Karande	7757882932		
19	Tejaswini Dilip Charan	8010819671		
20	Vetel Shivanjali Ramrao	8010118088		
21	Karale Aakanksha Chandrakant	9075105104		
22	Kadam Sakshi Milind	7020541437		
23	Mahajan Mukti Premchand	9373946505		
24	Shejwal Archana Raju	8485856454		
25	Inamdar Diya Ramjan	7709102458		

Sr.No	Candidates Name	Mob.No.	Session-I Sign.	Session-II Sign.
26	Jadhav Snehal Sanjay	7264038042	<i>SJadhav</i>	<i>SJadhav</i>
27	Nalawade Sonika Anil	9322766875	<i>SN</i>	<i>SN</i>
28	Pawar Pratik Shankar	7219415049	<i>SP</i>	
29	Chavan Shubham Sanjay	9107171117	<i>Shubham</i>	
30	Patil Suyash Jivan	7066813773		<i>Patil</i>
31	Kumbhar Peethmesh Popat	9561841929		<i>PKumbhar</i>
32	Kalaskar Abhishek Pandit	8850078968		<i>Kalaskar</i>
33	Shelage Gouridhanaji	8550987006		<i>Shelage</i>
34				
35				
36				
37				
38				
39				
40				
41				
42				
43				
44				
45				
46				
47				
48				
49				
50				
51				
52				
53				
54				
55				

Name & Sign. of TPC with Date.



Dr. Ashok Gujar Technical Institute's
Dr. Daulatrao Aher College of Engineering, Karad
Technical Training by- GTT, Pune

Date : 30/01/2023 to 01/02/2023 Venue: CR

Time: 9:30 am to 5: 30 pm

Date: 31/01/2023

Class: B.Tech

Branch: CSE

Sr.No	Candidates Name	Mob.No.	Session-I Sign.	Session-II Sign.
1	Vishvajit D. Suryawanshi	9579816391		
2	Karan More	7038936357		
3	Sohan Sutar	9767160939		
4	Snehal Patil	9665723402		
5	Mayuri Chavan	8554935834		
6	Priti More	7028506092		
7	Yadav Samiksha Ramesh	9504774747		
8	Kshirsagar Vaishnavi	8857087056		
9	Mrunali Shinde	9762830575		
10	Gaikwad Anuja Rajendra	9172352097		
11	Jadhav Shreya Sharad	7620434340		
12	Patil Pragati Mahesh	9884151913		
13	Mansurji Ami Dipakkumar	9421603958		
14	Patil Dipti Suryokant	8698823160		
15	Kumbhar Prajta Kamalakar	9307362509		
16	Patil Troupthi Suryokant	8698823161		
17	Khundagale Dhanshi chhagan	7249674690		
18	Pratibha Ranjay Patil	9022607510		
19	Mulla Muskan Fayyabali	9175658899		
20	Pawar Aishwarya Prakash	9021081086		
21	Pawar Omkar Shrinivas	7058076931		
22	Nikam Shubhankar Suresh	9225831193		
23	Siddesh Panjabrao Bhandare	8992346264		
24	Mulla Dawud Shabbir	7558706011		
25	yadav Vipul Vijay	9163492600		

Sr.No	Candidates Name	Mob.No.	Session-I Sign.	Session-II Sign.
26	Ashwin patil	8412017271		
27	Rohan Kadam	9503217630		
28	Pratimesh Shelar	8697612390		
29	Siddhant Horne	9604006773		
30	shailaja sathe	8010850378		
31	omkar Sawant	9565121993		
32	Rohit Dange	7410104141		
33	Parth Garware	9527328167		
34				
35				
36				
37				
38				
39				
40				
41				
42				
43				
44				
45				
46				
47				
48				
49				
50				
51				
52				
53				
54				
55				

Name & Sign. of TPC with Date.



Dr. Ashok Gujar Technical Institute's
Dr. Daulatrao Aher College of Engineering, Karad
Technical Training by- GTT, Pune

Date : 30/01/2023 to 01/02/2023 Venue: CR

Time: 9:30 am to 5: 30 pm

Date: 31/01/2023

Class: T.Y.

Branch: E&TC

Sr.No	Candidates Name	Mob.No.	Session-I Sign.	Session-II Sign.
1	Sanket Ghutugate	906113038	Sanket	
2	Aditya Kanase	9309210798	AK	
3	Bhagwant ^{Phalle} Patte mit.	9970698840	BPhalle	
4	Ayan Kazi	8698924640	Akazi	
5				
6				
7				
8				
9				
10				
11				
12				
13				
14				
15				
16				
17				
18				
19				
20				
21				
22				
23				
24				
25				



Dr. Ashok Gujar Technical Institute's
Dr. Daulatrao Aher College of Engineering, Karad
Technical Training by- GTT, Pune

Date : 30/01/2023 to 01/02/2023 Venue: CR

Time: 9:30 am to 5: 30 pm

Date: 31/01/2023

Class: T.Y. B.Tech (MECH) Branch: MECHANICAL

Sr.No	Candidates Name	Mob.No.	Session-I Sign.	Session-II Sign.
1	APHALE HZMANSHU DEVBHUSHAN.	7588333162	<u>Apshale</u>	<u>Apshale</u>
2	VELHAL RUTVIK SUNIL.	9156992957	<u>Rgretul</u>	
3	MORE PRATIK SATISH.	8010762605	<u>More</u>	
4	DESAI SHIVAM ASHOK.	8432196358	<u>Desai</u>	
5	BOBADE MAHESH SADASHIV.	9579060048	<u>ma</u>	
6	PAWAR ABHISHEK SHASHIKANT.	9579352526	<u>Dawar</u>	
7				
8				
9				
10				
11				
12				
13				
14				
15				
16				
17				
18				
19				
20				
21				
22				
23				
24				
25				



Dr. Ashok Gujar Technical Institute's
Dr. Daulatrao Aher College of Engineering, Karad
Technical Training by- GTT, Pune

Date : 30/01/2023 to 01/02/2023 Venue: CR

Time: 9:30 am to 5: 30 pm

Date: 1-2-23

Class: TYBTech

Branch: CSE

Sr.No	Candidates Name	Mob.No.	Session-I Sign.	Session-II Sign.
1	Mukti Premchand Mahajan	9373946505	Mukti	Mukti
2	Ditya Ramjan Inamdar	7709102458	Inamdar	Inamdar
3	Archana Raju Shejwal	8485856454	Ashejwal	Ashejwal
4	Salonee Pravin Shirsat	9834710741	Shirsat	
5	Saylee Sanjay Patil	9766652699	Patil	
6	Sanika Anil Nalawade	9322766875	SN	SN
7	Snehal Sanjay Jadhav	7264038042	SJadhav	SJadhav
8	Pranjali Sanjay Patil	9423453023	Pranjali	Pranjali
9	Suban Jameer Mulla	9975488562	Smilla	Smilla
10	Vetal Shivrajali Ramrao	8010118088	Petal	Petal
11	Kanale Aakanksha Chandrabai	9075105104	Kanale	Kanale
12	Lawand Manasi Mahesh	7058586833	Manand.	
13	Poojany Varsha Vasantha	9588650699	Varsha	
14	Pratiksha Balasaheb Yadav	9028720289	Pratiksha	
15	Gauri Dhanaji Shedage.	8750987006	gauri	gauri
16	shinde sanika sanjay.	9356107975	Sanika	Sanika
17	Pawar Dhanashri Nitin	9022449491	Pawar	Pawar
18	Padale Snehal Krishna	7757809415	Padale	Padale
19	Patil Vaishnavi Ashok	7492409271	Vpatil	Vpatil
20	Mujawar Sayama Dikawat	7720044636	SDM	SDM
21	Patil Suyash Jivan	7066813773	Spatil	Spatil
22	Chorage Radik	8010719163	Chorage	Chorage
23	Mohite Gaurav	9021884203	Gaurav	Gaurav
24	Kumbhar Prathmesh	9561841929	Prathmesh	Prathmesh
25	Kalukar Abhishek	9850073968	Kalukar	

Sr.No	Candidates Name	Mob.No.	Session-I Sign.	Session-II Sign.
26	Manodik Viroj Nitin	8975779161	<i>Manodik</i>	<i>Manodik</i>
27	Shreya Dadasa Patil	9021102310	<i>Shreya</i>	<i>Shreya</i>
28				
29				
30				
31				
32				
33				
34				
35				
36				
37				
38				
39				
40				
41				
42				
43				
44				
45				
46				
47				
48				
49				
50				
51				
52				
53				
54				
55				

Name & Sign. of TPC with Date.



Dr. Ashok Gujar Technical Institute's
Dr. Daulatrao Aher College of Engineering, Karad
Technical Training by- GTT, Pune

Date : 30/01/2023 to 01/02/2023 Venue: CR

Time: 9:30 am to 5: 30 pm

Date: 1-2-23

Class: BE

Branch: CSE

Sr.No	Candidates Name	Mob.No.	Session-I Sign.	Session-II Sign.
1	Pawar Aishwarya Prakash	9021031086	<i>A.P. Pawar</i>	
2	more Priti Vikas	7028506092	<i>(P)more</i>	<i>(P)more</i>
3	Suryawanshi Vishwajit D.	9579816391	<i>Suryawanshi</i>	<i>Suryawanshi</i>
4	More Karan	7038936357	<i>Karan</i>	<i>Karan</i>
5	Patil snehal	9565723402	<i>(S)patil</i>	<i>(S)patil</i>
6	Ami Dipakkumar Mansurji	9421603958	<i>Ami</i>	
7	more sanjay delai	9370572787	<i>Sanjay</i>	<i>Sanjay</i>
8	Monali Ravi Kant Jadhav	8208879145	<i>Monali</i>	<i>Monali</i>
9	Ashwin Babasaheb patil	8412017271	<i>Ashwin</i>	
10	David Ghobhir Mulla	7558706011	<i>D.S. mulla</i>	
11	urushikesh sutyakant Mane	8483830448	<i>U. Mane</i>	
12	Shelar Prathmesh Balaso	8657612390	<i>Shelar</i>	
13	Bhosale Peasad Sunil	9822545182	<i>Bhosale</i>	
14	Nikam Shubhenkar Suresh	9225831193	<i>Nikam</i>	
15	Pawar Omkar Shrinivay	7058076931	<i>Omkar</i>	
16	Sawant Omkar Sidhharath	9561214133	<i>Sawant</i>	
17	Yadav vipul vijay	9763492800	<i>Yadav</i>	
18	Rohan Sanjay Kadam	9503217630	<i>RKadam</i>	
19	Nikhil Ghore	7770030956	<i>Nikhil</i>	
20	Rohit Dange	8485873277	<i>Rohit</i>	<i>Rohit</i>
21	Horme Siddhant	9604004773	<i>Horme</i>	<i>Horme</i>
22	Karan more	7038930357	<i>Karan</i>	<i>Karan</i>
23	Parth Garware	9529328167	<i>Parth</i>	<i>Parth</i>
24				
25				



Dr. Ashok Gujar Technical Institute's
Dr. Daulatrao Aher College of Engineering, Karad
Technical Training by- GTT, Pune

Date : 30/01/2023 to 01/02/2023 Venue: CR

Time: 9:30 am to 5: 30 pm

Date: 1-2-23

Class: BE

Branch: ENTC

Sr.No	Candidates Name	Mob.No.	Session-I Sign.	Session-II Sign.
1	Shinde Shradha Dattatray	9665149606	<u>Shinde</u>	
2	Jadhav Nikita Bhagwan	8378894288	<u>Nradhav</u>	
3	Autade Rutuja vilas	9527760542	<u>Rutade</u>	
4	Mahamuni Kalyani pradeep	7397887178	<u>Mahamuni</u>	
5	Reke Vaishnavi Raju	7558385551	<u>Reke</u>	
6	Todkar Reva Uday	7875269776	<u>Todkar</u>	
7	Kate Shradha Santosh	9325720027	<u>Kate</u>	
8	Ningadale Snehal Kalyan	7387744886	<u>SkNingadale</u>	
9				
10				
11				
12				
13				
14				
15				
16				
17				
18				
19				
20				
21				
22				
23				
24				
25				



Dr. Ashok Gujar Technical Institute's
Dr. Daulatrao Aher College of Engineering, Karad
Technical Training by- GTT, Pune

Date : 30/01/2023 to 01/02/2023 Venue: CR

Time: 9:30 am to 5: 30 pm

Date: 01/02/2023

Class: T. Y. B-Tech (MECH)

Branch: MECHANICAL

Sr.No	Candidates Name	Mob.No.	Session-I Sign.	Session-II Sign.
1	APHALE HIMANSHU DEVBHUSHAN.	7588333162		
2	VELHAL RUTVIK SUNIL.	9156992957		
3	MORE PRATIK SATISH.	8010762605		
4	DESAI SHIVAM ASHOK.	8422196358		
5	PAWAR ABHISHEK SHASHIKANT.	9579352526		
6	BOBADE MAHESH SADASHIV.	9579060048		
7	PATIL SANGRAM MARUTI.	7219480483		
8	KUMBHAR AVISHKAR SANTOSH.	705783609		
9	DINGANE OMKAR SHEVAJI.	8830444197		
10	JAMALE TUSHAR NATHURAM.	9370518219		
11	BAGWAN SHOHEB JABBAR.	7559324810		
12	PATEL AAVEJ VAHID.	9834204940		
13	JADHAV BALWANT ANANDA.	8530115806		
14	MAHADIK ANIRUDDHA ANANDRAO.	8412085605		
15				
16				
17				
18				
19				
20				
21				
22				
23				
24				
25				



GTT, Pune



Dr. Ashok Gujar Technical Institute's
Dr. Daulatrao Aher College of Engineering, Karad
Soft Skills Training by- Rubicon Pune

20

Date : 02/02/2023 to 04/02/2023 Venue: CR

Time: 10:00 am to 5:00 pm

Date: 2/2/2023

Class: TY & Btech

Branch: CSE

Sr.No	Candidates Name	Class & Branch	Mob.No.	Session-I Sign.	Session-II Sign.
1	Omkar Sidhanath Sawant	B.Tech CSE	9561214133		
2	Rohan Ganjani Kadam	B.Tech CSE	9503217070		
3	Vishal Ramkrishna Patil	T.Y. CSE	9730220101		
4	Mayur Pratap Pawar	T.Y. CSE	9359298530		
5	Mujawar Saad	T.Y. CSE			
6	Cheistiyam Shine Juyan	T.Y. CSE	7219649364		
7	Moolya Nidhish plaxyan	T.Y. CSE	9370217137		
8	Tapase Harshada Ashok	B.Tech	9595111895		
9	Gharge pranali kalyan	B.Tech	9689515411		
10	Snehal Ramesh Patil	B.Tech	966572342		
11	Shinde Namrata	B.Tech	7774927171		
12	Mane Radhika	B.Tech	7619894931		
13	Sankpal Trushna	B.Tech	7821950234		
14	Neha Nitin Pansande	B.Tech	7249739306		
15	Maitthili vasant Tirmore	B.Tech	9067373396		
16	Salunkhe Rudra Sandob	T.Y. CSE	8010821614		
17	Sonawale Sahshi Baburao	T.Y. CSE	7391915503		
18	Priti vikas more	B.Tech	7028506092		
19	Aishwarya Prakash Pawar	B.Tech	9021031086		
20	Pawar Dhanashri Nitin	T.Y. B.Tech	9022449491		
21	Gadale Snehal Krishna	T.Y. B.Tech	9759809415		
22	Jadhav Snehal Sanjay	T.Y. B.Tech	7266038042		
23	Kate Asmita Yuvraj	T.Y. B.Tech	9552458004		
24	Nalawade Sanika Anil	T.Y. B.Tech	9302766875		
25	Kadam Sakshi Milind	T.Y. B.Tech	7020541437		

Sr.No	Candidates Name	Class & Branch	Mob.No.	Session-I Sign.	Session-II Sign.
26	Inamdar Diya Ramjan	T.Y.CSE	7709102458	<i>Inamdar</i>	<i>Inamdar</i>
27	Mahajan Mukti Premchand	T.Y.CSE	9373946505	<i>Mukti</i>	<i>Mukti</i>
28	Mujawar Sayama Dilawar	T.Y.CSE	7720044636	<i>PM</i>	<i>PM</i>
29	Mulla Swaliha Haroon	B.Tech	8767126637	<i>S.H.Mulla</i>	
30	Shinde Sanika Sandeep	T.Y.CSE	9860851711	<i>Shinde</i>	
31	Lohar Prajakta Prakash	T.Y.CSE	7020421530	<i>Prajakta</i>	
32	Shete Sakshi Dhananjay	T.Y.CSE	8956452047	<i>Shete</i>	
33	Chavange Ankita Chandrakant	T.Y.CSE	47499201441	<i>Chavange</i>	<i>Chavange</i>
34	Chavan Tejaswini Dilip	T.Y.CSE	8010819671	<i>Chavan</i>	<i>Chavan</i>
35	Karande Neha Ganesh	T.Y.CSE	7757882932	<i>Neha</i>	<i>Neha</i>
36	Salonee Pravin Shirat	T.Y.CSE	9884710741	<i>Salonee</i>	
37	Patil Saylee Sanjay	T.Y.CSE	9766652699	<i>Patil</i>	
38	Rawat Pratik Shankar	T.Y.CSE	7219415049	<i>Rawat</i>	
39	Shedage Kavri Dhanaji	T.Y.CSE	8550987006	<i>Shedage</i>	
40	Kumbhar Prathmesh	T.Y.CSE	9561841929	<i>Kumbhar</i>	
41	Patil Suyash Jivan	T.Y.CSE	7066813773	<i>Patil</i>	
42	Coutts Glenn Gilbert	T.Y.CSE	7774970731	<i>Coutts</i>	<i>Glenn</i>
43	Prathmesh Yuvraj Nagru	T.Y.CSE	7755949010	<i>Prathmesh</i>	
44	ASWIN Ambashap Patil	B.Tech	9421180995	<i>ASWIN</i>	
45	VIPUL Vijay Patil	B.Tech	9421180999	<i>VIPUL</i>	
46	Rohit Dange	B.Tech	8485813277	<i>Rohit</i>	
47	Vishwajeet Patil	B.Tech	7038675551	<i>Vishwajeet</i>	
48	Patil Vaishnavi Ashok	T.Y.CSE	7498409271		<i>Patil</i>
49					
50					
51					
52					
53					
54					
55					

Name & Sign. of TPC with Date.



Dr. Ashok Gujar Technical Institute's
Dr. Daulatrao Aher College of Engineering, Karad
Soft Skills Training by- Rubicon, Pune

Date : 02/02/2023 to 04/02/2023 Venue: CR

Time: 10:00 am to 5: 00 pm

Date: 02/02/2023

Class: B.Tech & T.Y. (Mech)

Branch: Mech

Sr.No	Candidates Name	Class & Branch	Mob.No.	Session-I Sign.	Session-II Sign.
1	Mulla Benzir Jakir	Mech ^{B.Tech}	9284928597	<u>Bmulla</u>	
2	Pawar Vaishnavi. S.	B.Tech	7841991520	<u>Vspawar</u>	
3	Mulani Muskan A	B.tech	8169689092	<u>Mulani</u>	
4	Patel Aashiya Tajuddin	T.Y.mech	9209265857	<u>Patel</u>	
5	Patel Aavej Vahid	T.Y.mech	9834204946	<u>Patel</u>	
6	Bagwan Soheb Tabbar	T.Y.Mech	7559894813	<u>S.T.Bagwan</u>	
7	Dhumej Rohit Mohan	T.Y.mech	7758950785	<u>Dhumej</u>	
8	Kokare Vishwajeet S.	T.Y.Mech	9284387067	<u>Kokare</u>	
9	APHALE HIMANSHU DEVBHUSHAN	T.Y. Mech	7588833162	<u>Apale</u>	<u>Apale</u>
10	Pawar Abhishak Shashikant	T.Y.Mech	9579352526	<u>Pawar</u>	<u>Pawar</u>
11	Patil Songram Maruti	T.Y.mech	7219480483	<u>Patil</u>	
12	Kamble Aditya Dilip	T.Y.Mech	9922069794	<u>Kamble</u>	
13	Jamate Tushar Nathuram	T.Y.Mech	9370528229	<u>Jamate</u>	<u>Jamate</u>
14	Shinde Rushikesh Suhad	B.Tech	9579779008	<u>Shinde</u>	
15	Yadav Prasad Prakash	B.Tech	9665546302	<u>Yadav</u>	
16	Shah Yash Prashant	B.Tech	9922523204	<u>Shah</u>	
17	Kumbhar Avishkar S.	T.Y.Mech	7057831609	<u>Kumbhar</u>	
18	Jamdar Sarang S.	B.tech	8459046950	<u>Jamdar</u>	
19	Ramdasi Anuj H.	B.tech	8380863538	<u>Ramdasi</u>	
20	Desai. shivam .A	T.Y.mech	8432196358	<u>Desai</u>	<u>Desai</u>
21	Mahadik Aniruddha A.	T.Y. Btech	8412085605	<u>Mahadik</u>	<u>Mahadik</u>
22	Velhal Rutvik Sunil	T.Y.Btech	9156992957	<u>Velhal</u>	<u>Velhal</u>
23	Jadhav Balavant A.	T.Y.BTech	8530115806	<u>Jadhav</u>	
24	Patel Shoyab Altaf	T.Y.BTech	7020067826	<u>Patel</u>	
25	Bobade Mahesh Sadashiv	T.Y.B.Tech	9579060048	<u>Bobade</u>	

Sr.No	Candidates Name	Class & Branch	Mob.No.	Session-I Sign.	Session-II Sign.
26	Pratik Satish More.	Mech	8010762605		
27	Omkar Shivaji Dingane	Mech	8830444197		
28	Pol Akanksha Sanjay	Mech	920836679		
29	Rasika Rajendratate	Mech	9359304625		
30	Nikam Hrishikesh K.	Mech	9284313261		
31	Sawant Saizaj Suresh	Mech	7387741999		
32					
33					
34					
35					
36					
37					
38					
39					
40					
41					
42					
43					
44					
45					
46					
47					
48					
49					
50					
51					
52					
53					
54					
55					

Name & Sign. of TPC with Date.



Dr. Ashok Gujar Technical Institute's
Dr. Daulatrao Aher College of Engineering, Karad
Soft Skills Training by- Rubicon, Pune

Date : 02/02/2023 to 04 /02/2023 Venue: CR

Time: 10:00 am to 5: 00 pm

Date: 2/02/2023

Class: TE./BTech

Branch: Civil

Sr.No	Candidates Name	Class & Branch	Mob.No.	Session-I Sign.	Session-II Sign.
1	Jadhav Anati Bhiku	BTech	7743983750		
2	Thorat Nehal Dadaso	B.Tech	8623802610		
3	Nalawade Vrushali Suraj	B.Tech	8600919652		
4	Patil Bhagyashri Dilip.	B.Tech	8669415644		
5	Chunrade Shubhada Kedappa	B.Tech	8421600485		
6	Hattigote prerana shiraji	B.Tech	9359552547		
7	Jadhav Shraddha M.	T.Y	8482802402		
8	Dingane Prachi R.	T.Y	8888064325		
9	Jadhav Dhiraj S.	T.Y.	7620976798		
10	kadam Anuja C.	T.Y.	8080357319		
11	Patil Trupti S.	T.Y.	7038271734		
12	Tujar Tejaswi Suresh	T.Y	8010503075		
13	Waghmare Ankita R.	B.Tech	9579076689		
14	More Rahul Siteram	B.Tech	8590373545		
15	Garkwad Ajay Janardan	B.Tech	9920090685		
16					
17					
18					
19					
20					
21					
22					
23					
24					
25					



Dr. Ashok Gujar Technical Institute's
Dr. Daulatrao Aher College of Engineering, Karad
Soft Skills Training by- Rubicon Pune
Date : 02/02/2023 to 04/02/2023 Venue: CR
Time: 10:00 am to 5: 00 pm

Date: 2/02/2023

Class: TE/B.Tech

Branch: E&TC

Sr.No	Candidates Name	Class & Branch	Mob.No.	Session-I Sign.	Session-II Sign.
1	Kenissa Gouza	T.Y	705828606	<u>[Signature]</u>	
2	Vaishnavi mane	T.Y.	7558663262	<u>[Signature]</u>	
3	Afsana Patel.	T.Y.	9689235307	<u>[Signature]</u>	
4	Pratami Shetty	T.Y.	9623140669	<u>[Signature]</u>	
5	Rutuja patil.	T.Y	7020558900	<u>[Signature]</u>	
6	Shruti patil.	T.Y.	9172370019	<u>[Signature]</u>	<u>[Signature]</u>
7	Shweta mane	T.Y	932528544	<u>[Signature]</u>	
8	Kalyani Mahamuni	BTech	7397887178	<u>[Signature]</u>	
9	Shravani Shete	B.Tech	7219897004	<u>[Signature]</u>	<u>[Signature]</u>
10	Shraddha Shinde	B.Tech	9665149606	<u>[Signature]</u>	<u>[Signature]</u>
11	Nikita Jadhav	B.Tech	8372894288	<u>[Signature]</u>	<u>[Signature]</u>
12	Rutuja Avatade	B.Tech	9527760542	<u>[Signature]</u>	<u>[Signature]</u>
13	Karan Desai	B.Tech	9834461556	<u>[Signature]</u>	<u>[Signature]</u>
14	Pratiksha Chavan	B.Tech	9730327563	<u>[Signature]</u>	<u>[Signature]</u>
15	Shivani misal	B.Tech	7277551222	<u>[Signature]</u>	<u>[Signature]</u>
16	Priyanka Pawar	B.Tech	9767313659	<u>[Signature]</u>	<u>[Signature]</u>
17	Ningadale Snehal Kalyan	B.Tech	7887744886	<u>[Signature]</u>	<u>[Signature]</u>
18	Phalle Bhagavant Anil	B.Tech	9970698840	<u>[Signature]</u>	
19	Nikam Pranav Subhash	B.Tech	7620511847	<u>[Signature]</u>	
20	Kazi Ayan Nasir	T.Y.E&TC	8698824660	<u>[Signature]</u>	
21	Magdum Swapnali	T.Y.E&TC	7083796588	<u>[Signature]</u>	
22					
23					
24					
25					



Rubicon, Pune



Karad, Maharashtra, India
858W+745, Karad, Maharashtra 415124, India
Lat 17.315349°
Long 74.19528°
07/06/22 04:59 PM



G. K. Gujar Memorial Charitable Trust's
Dr. Ashok Gujar Technical Institute's
Dr. Daulatrao Aher College of Engineering, Karad
 Accredited by NAAC with B+ & ISO 9001-2008 Certified Institute
 Training & Placement Cell

19

DACOE/ TPO/2022-2023/

Date 06/02/2023

Symbiosis- Job Oriented Technical Training-2023/2022/2021 Batch B.Tech.-All

Dear All,

Greetings from AGTI's DACOE, Karad & Symbiosis Skills & Professional University, Pune!!!

It gives us immense pleasure to inform you that, Symbiosis Skills & Professional University has come up with Free of Cost, Job Oriented Training along with Project based, industry aligned curriculum and focus on Hands on skilling.

1) Certificate Course in JAVA FULL STACK

Duration- 3.5 months
 Daily 3 to 4 hrs Classroom & Lab Training at CSE Dept. AGTI's DACOE- Karad
 Branches applicable- CSE & ENTC
 Batch- B. Tech. 2021/2022/2023

2) Certificate Course in SOFTWARE TESTING

Duration- 3.5 months
 Daily 3 to 4 hrs Classroom & Lab Training at CSE Dept. AGTI's DACOE- Karad
 Branches applicable- MECH, ENTC (Civil if Interested)
 Batch- B. Tech. 2023/2022/2021

Selection Process: 1) Orientation Session 2) Aptitude Test 3) Personal Interview

Date & Time of Selection Process:

Date: 11/02/2023 Time: 10:30 am Venue: Auditorium & TPO Dept.

Registration Last Date: 08/02/2023

Registration Link: <https://forms.gle/1MQJoJeQNp59JRUP7>

Principal

Cc:

Vice Principal		Dean- Academic	
HOD - EXTC		HOD - CSE	
HOD- MECH	F. B. R. K.	HOD- CIVIL	
TPC-ENTC		TPC-CSE	
TPC-CIVIL		TPC-MECH	F. B. R. K.



G. K. Gujar Memorial Charitable Trust's
Dr. Ashok Gujar Technical Institute's
Dr. Daulatrao Aher College of Engineering, Karad

Accredited by NAAC with A Grade & ISO 9001-2008 Certified Institute

Training & Placement Cell
Symboisys Technical Training

Date: 11/02/2023

Sr.No.	Complete Name	Course Name	Branch	Mobile Number	Orientation Sig	Test Sign.	G.D. Sign.
1	Ganesh Ankush khabale.	B.Tech.-2023	ENTC	7387069194			
2	Salina Sameer Mulla	B.Tech.-2023	ENTC	9067816248			
3	Snehal kalyanrao Ningadale	B.Tech.-2023	ENTC	7387744886	S.k.Ningadale	S.k.Ningadale	
4	Misal Shivani Sanjay	B.Tech.-2023	ENTC	7277551222			
5	Reva Uday Todkar	B.Tech.-2023	ENTC	7875269776	R.todkar	R.todkar	
6	Shravani Hemant Shete	B.Tech.-2023	ENTC	7219897004			
7	Rutuja Vilas Autade	B.Tech.-2023	ENTC	9527760542			
8	Divya Raghunath Chavan	B.Tech.-2023	ENTC	+918421728317			
9	Shraddha Dattatray Shinde	B.Tech.-2023	ENTC	9665149606			
10	Shambhuraj Chandrakant Patil	B.Tech.-2023	ENTC	7249384095	S.patil	S.patil	
11	Karan Ashok Desai	B.Tech.-2023	ENTC	9834461556			
12	Divya Raghunath Chavan	B.Tech.-2023	ENTC	+918421728317			
13	Vishwajeet murlidhar jadhav	B.Tech.-2023	ENTC	9359003973			
14	Aditi Uddhav Jadhav	B.Tech.-2023	ENTC	7666115372	A.J.Jadhav	A.J.Jadhav	
15	Omkar Dilip Pawar	B.Tech.-2022	ENTC	8484848027	O.pawar	O.pawar	
16	Shravani Hemant Shete	B.Tech.-2023	ENTC	7219897004	hshete	hshete	
17	Shraddha Santosh Kate	B.Tech.-2023	ENTC	9325720027	S.kate	S.kate	
18	Kalyani pradeep mahamuni	B.Tech.-2023	ENTC	7397887178			
19	Omkar laxman kadam	B.Tech.-2023	ENTC	8421725286			
20	Uday Sudhir Mane	B.Tech.-2023	ENTC	09561741139	U.Man	U.Man	
21	Ruksar Faruk Patel	B.Tech.-2022	ENTC	07397861551			
22	Vishwajeet murlidhar jadhav	B.Tech.-2023	ENTC	9359003973			



G. K. Gujar Memorial Charitable Trust's
Dr. Ashok Gujar Technical Institute's
Dr. Daulatrao Aher College of Engineering, Karad

Accredited by NAAC with A Grade & ISO 9001-2008 Certified Institute

Training & Placement Cell
Symboisys Technical Training

Date: 11/02/2023

Sr.No.	Complete Name	Course Name	Branch	Mobile Number	Orientation Sig.	Test Sign.	G.D. Sign.
1	Anuja Rajendra Gaikwad	B.Tech.-2023	CSE	9172352097			
2	Siddhant Dipak Harne	B.Tech.-2023	CSE	9604004773			
3	Karan Abasaheb More	B.Tech.-2023	CSE	7038936357	Kar	Kar	
4	Pratiksha Sanjay Patil	B.Tech.-2023	CSE	9022607510			
5	Shubhankar Suresh Nikam	B.Tech.-2023	CSE	9225831193			
6	Manali Ravikant Jadhav	B.Tech.-2023	CSE	8208379145			
7	Omkar Sidhanath Sawant	B.Tech.-2023	CSE	9561214133	O.Sawant	O.Sawant	
8	Mrunali Nanaso Shinde	B.Tech.-2023	CSE	9762830575			
9	Vishwajit Dipak Suryawanshi	B.Tech.-2023	CSE	9579816391			
10	Ami Dipakkumar Mansuriya	B.Tech.-2023	CSE	9421603958			
11	Diksha Rajesh Adsule	B.Tech.-2023	CSE	9145247025			
12	Maithili Vasant Tirmare	B.Tech.-2023	CSE	9067373396	MVI..	MVI..	
13	Neha nitin pansande	B.Tech.-2023	CSE	7249739306	NNP	NNP	
14	Kadam Kajal Chandrakant	B.Tech.-2023	CSE	9850130244	K.C.Kadam	K.C.Kadam	
15	Ekta Ravindra Sawant	B.Tech.-2023	CSE	8668332704	E.Sawant	E.Sawant	
16	Trupti Suryakant Patil	B.Tech.-2023	CSE	8698823161	T.Patil	T.Patil	
17	Dipti Suryakant Patil	B.Tech.-2023	CSE	8698823160	D.Patil	D.Patil	
18	Bhagyashree Shashikant Gurav	B.Tech.-2023	CSE	8459991695	B.Gurav	B.Gurav	
19	Sohan Dhanaji Sutar	B.Tech.-2023	CSE	9767160938			
20	Pallavi Kundlik Katre	B.Tech.-2023	CSE	9322488289			
21	Ashwin Babasaheb Patil	B.Tech.-2023	CSE	8412017271			
22	Harshada Ashok Tapase	B.Tech.-2023	CSE	9595111395	H.Tapase	H.Tapase	

Sr.No.	Complete Name	Course Name	Branch	Mobile Number	Orientation Sign	Test Sign	U.D. Sign.
23	Isha Sandip Bondre	B.Tech.-2023	CSE	7387790443	Ishabondre	Ishabondre	
24	Pranali kalyan Gharge	B.Tech.-2023	CSE	9689515411	PranaliGharge	PranaliGharge	
25	Pawar Aishwarya prakash	B.Tech.-2023	CSE	9021031086	AishwaryaPawar	AishwaryaPawar	
26	Namrata Mahadeo Shinde	B.Tech.-2023	CSE	7774927171	NamrataShinde	NamrataShinde	
27	Priti Vikas More	B.Tech.-2023	CSE	7028506092	PritiMore	PritiMore	
28	Mayuri Vikas Chavan	B.Tech.-2023	CSE	8554935834	MayuriChavan	MayuriChavan	
29	Mayuri Sanjay Desai	B.Tech.-2023	CSE	9370572782	MayuriDesai	MayuriDesai	
30	Vishwajeet vijaykumar suryaw	B.Tech.-2023	CSE	9527184379	VishwajeetSuryawanshi	VishwajeetSuryawanshi	
31	Rutuja Prashant Shinde	B.Tech.-2023	CSE	7709788265	RPShinde	RPShinde	
32	Rutuja Anil Koli	B.Tech.-2023	CSE	7558676557			
33	Sohan Dhanaji Sutar	B.Tech.-2023	CSE	+919767160938			
34	Radhika Rajendra Mane	B.Tech.-2023	CSE	7719894931	R.R.Mane	R.R.Mane	
35	Uday Dnyandev Raje	B.Tech.-2023	CSE	9021101675			
36	Kumbhar Prajka Kamalakar	B.Tech.-2023	CSE	9307362504	Kumbhar	Kumbhar	
37	Rohan sanjay kadam	B.Tech.-2023	CSE	9503217630	Rohankadam	Rohankadam	
38	Swaliha Haroon Mulla	B.Tech.-2023	CSE	8767126637	S.H.Mulla	S.H.Mulla	
39	Neha nitin pansande	B.Tech.-2023	CSE	7249739306			
40	Omkar Sidhanath Sawant	B.Tech.-2023	CSE	9561214133			
41	Nikita Mukund Adake	B.Tech.-2023	CSE	9146728122			
42	Rutuja Vishal Girigosavi	B.Tech.-2023	CSE	08788698969			
43	Parth Vivek Garware	B.Tech.-2023	CSE	9527328167	ParthGarware	ParthGarware	
44	Dhanshri Chhagan Khandagale	B.Tech.-2023	CSE	7249674690	DhanshriKhandagale	DhanshriKhandagale	
45	Bhagyashree Shashikant Gurav	B.Tech.-2023	CSE	8459991695	BhagyashreeGurav	BhagyashreeGurav	
46	Karan-Abasaheb-More	B.Tech.-2023	CSE	7038936357			
47	Sawant Ekta Ravindra	B.Tech.-2023	CSE	8668332704	EktaSawant	EktaSawant	
48	Kadam-Kajal-Chandrakant	B.Tech.-2023	CSE	9850130244	K.C.Kadam	K.C.Kadam	
49	Trushna sanjay pandugade	B.Tech.-2023	CSE	7821950235			
50	Vishwajit Dipak Suryawanshi	B.Tech.-2023	CSE	9579816391			
51	Dhanashri Hanmant Yedage	B.Tech.-2023, B.Tec	CSE	7767910492			
52	Nikita Anil Yadav	B.Tech.-2023	CSE	7420991333			
53	Pranali Arun Suryawanshi	B.Tech.-2023	CSE	9552693272	PranaliSuryawanshi	PranaliSuryawanshi	
54	Mayuri Vikas Yadav	B.Tech.-2023	CSE	7420841756	MayuriYadav	MayuriYadav	

Group - ① Social Med^{of} Dt. 13/3/2023

Sr. No.	Full Name	Branch	College Name	Apt. score 30	Written 10	GD 30	Sign.
1	Prabod Yadav	MECH				12	
2	Prabod Pawar	MECH				15	
3	Vishwajeet Jadhav	ENTC				14	
4	Rmbhar Pawar	CSE				18	
5	Daud Mulla	CSE				10	
6	Sonali Sonawali	MECH				14	
7	Mrunali Chinde	CSE				13	
8	Rubya Anavade	ENTC				12	
9	Payal Jadhav	CSE				13	
10	Soham Sutar	CSE				17	
11	Rubya Koli	CSE				14	
12	Ashwin Pali	CSE				10	
13	Pruthviman Shelar	CSE				12	
14	Anuya Gaikwad	CSE				14	
15	Dhanshi Redge	CSE				10	
16	Anu Ramdas	MECH				15	
17	Ravika Jathe	MECH				13	
18	Rajesh Mabe	MECH				12	
19	Ganesh Ghabale	ENTC				14	
20	Shradha Shinde	ENTC				14	
21	Dallan Kalye	ENTC				13	
22	Sorana Jamdar	MECH				14	
23	Azuddin Attar	MECH				12	
24	Sanket Sathre	MECH				14	
25	Nikita Jadhav	ENTC				13	
26	Vishwajeet Suryan	CSE				18	
27	Rubik Dolage	MECH				16	
28	Dhanshi Kadam	ENTC				13	
29	Sidhant Harne	CSE				14	
30	Karhila Wangde	CSE				17	
31	Shreyas Jadhav	CSE				18	
32	Nikita Adale	CSE				19	

②
Education System

Yes
③
Disaster Mgmt



Sybosis Pune

One Week
Short Term Training Programme
On
“CAD (SOLIDWORKS) applications in
industry”
(13th MAR. to 18th MAR. 2023)

Registration Form

1. Full Name (in Block Letters):.....
.....
2. Designation:.....
3. Organisation Address:.....
.....
.....
4. Contact No:.....
5. E-mail Id:.....
.....
6. Registration Details:
DD No./Cash.....
Date Withdrawn.....
Name of Bank.....
.....
7. Accommodation Required: YES/NO

Applicant's
Signature

Signature of Authority
with Seal

REGISTRATION FEES:

UG/PG Student Participant =1300/- INR
Faculty Participant =1500/- INR
Industry Participant=2500/-INR

Note:

No TA DA will be provided to the participants for attending the course. Limited accommodation available on payment basis.

IMPORTANT DATES:

Last Date of Registration: 10th MAR. 2023
Date of Confirmation: 11th MAR. 2023.

DATE AND VENUE:

The Short Term Training Programme will be held during **13-18th March, 2023** at CAD lab, Mechanical Engineering Department, Dr. Daulatrao Aher College of Engineering, Karad.

ADDRESS TO COMMUNICATIONS:

Prof. Vinayak D. Yadav
Co-ordinator,
Department of Mechanical Engineering
AGTI's Dr. Daulatrao Aher College of Engineering,
Vidyanagar Extn. Banawadi,
415124, Karad, Dist: Satara, Maharashtra, INDIA
Phone: (02164) 272701/02; Fax: (02164) 272703



G.K. Gujar Memorial Charitable Trust's
Dr. Ashok Gujar Technical Institute's
DR. DAULATRAO AHER COLLEGE OF
ENGINEERING, KARAD



One Week Short Term Training
Programme on
“CAD (SOLIDWORKS) applications in
industry”

(13th Mar. to 18th Mar. 2023)



Organized by,
Department of Mechanical Engineering,
Dr. Daulatrao Aher College of Engineering,
Vidyanagar Extension,
Banwadi, Karad, Maharashtra, India

ABOUT INSTITUTION:

Dr. Daulatrao Aher College of Engineering, Karad was established in 2008 by Dr. Ashok G. Gujar, as part of Shri G. K. Gujar Memorial Charitable Trust's activities at Karad. The Institute is approved by the All India Council for Technical Education (AICTE) New Delhi, Directorate of Technical Education (DTE) Mumbai and Government of Maharashtra and is affiliated to Shivaji University Kolhapur. The Institute offers Undergraduate Engineering Programs in Mechanical Engineering, Electronics & Telecommunication Engineering, Civil Engineering and Computer Science & Engineering leading to B.Tech Degree as per Shivaji University Curriculum.

ABOUT DEPARTMENT:

Mechanical Engineering Department was established in the year 2008. The Department has a team of highly qualified and experienced faculty. Research activities at the department are progressing in the areas of feature based design, design optimization of Mechanical systems, Flexible Mechanisms, alternative fuels for IC engines, thermal energy storage and material technology. Mechanical Engineering envisaged the development, design, manufacturing and maintenance of machinery. The present age demands Mechanical Engineering specialists who have the capacity of adaptability and creativity in the new technical areas. Mechanical engineers should have knowledge not only in their own specialized fields but also in wide inter disciplinary fields as well to meet the above requirements.

HOW TO APPLY:

Interested participants are requested to send, filled and duly signed Registration form along with Demand Draft of course fees as applicable in favor of "MECH AGTI DACOE" payable at Karad. to the said address. This fee will cover refreshment. **There are only limited no of participants for the course on first come first serve basis.**

CHIEF PATRONS

Hon. Dr. Ashok G. Gujar

Chairman, G. K. Gujar Memorial Charitable Trust, Karad

Shri. Indrajit A. Gujar

Vice Chairman, G. K. Gujar Memorial Charitable Trust, Karad

Dr. Madhuri I. Gujar

Secretary, Dr. Daulatrao Aher College of Engineering, Karad

PATRON

Dr. Anwar M. Mulla

Principal, Dr. Daulatrao Aher College of Engineering, Karad (Maharashtra)

Prof. Hanmant M. Kumbhar

Vice Principal, Dr. Daulatrao Aher College of Engineering, Karad (Maharashtra)

CONVENER

Prof. Sarafraj J. Mulani

Head, Department of Mechanical Engineering
Mb. 9922813970

E-mail: hodmechanical@dacoec.ac.in

COURSE COORDINATORS

Prof. Vinayak D. Yadav -Mb.9766532789

Prof. Hemant K. Shete-Mb. 9420696944

Department of Mechanical Engineering,

E-mail: vdyadav.mech@dacoec.ac.in

ORGANIZING COMMITTEE

Dr. V.M.Jamadar	Mr. V.V.Rangate	Mr.S.D.Bagade
Mr. P. S. Mohite	Mr.A.D.Awasare	Mr. P. S. Gunwant
Mr. R.R. Chavan	Mr. P. P. Bhise	Miss.S.V.Janugade
Mrs.A.B. Shelar	Mr. R.A.Yadav	

ABOUT THE COURSE:

Computer Aided Design is extensively used in the design of tools and machinery used in the manufacture of components and Design courses like CATIA, CREO, NX etc. has wide range of application in the industry, Department of Mechanical Engineering arranged vocational training of these courses for the third year and final year students. SOLIDWORKS course covers the fundamentals of SOLIDWORKS and is the foundation on which we can build our modeling skills Part Modeling and Assembly Modeling will complete our knowledge of solids modeling tools and techniques. Also complex or organic shapes, Advanced Surfacing Modeling will be introduced

COURSE OBJECTIVES:

- Understand the underlying concepts of 3d modeling.
- Create basic to intermediate solid models using SOLIDWORKS software.
- Compose an assembly of multiple parts.
- Detail out blueprints based on solid models or assemblies.

COURSE CONTENT:

- Introduction to CAD, CAM, Features of Solidworks,
- SKETCHER
- Sketch Tools -
- PART MODELING
- Creating Loft features, Creating curves -
- Inserting Fastening features- Mounting boss, snap hook
- ASSEMBLY MODELING
- SURFACE MODELING
- Drafting

RESOURCE PERSONS:

Experienced faculties from reputed institutions and professional trainers from Design Solutions Karad

	G.K. Gujar Memorial Charitable Trust's Dr. Ashok Gujar Technical Institute's, Dr. Daulatrao Aher College of Engineering, Karad. Vidyanagar Ext. Banawadi, Tal. Karad 415124, Dist. Satara, Maharashtra INDIA
	Department of Mechanical Engineering

CAD (SOLIDWORKS) applications in industry TRAINING

Sr. No	Name of Student	Date: 13/3	14/3	15/3	16/3	17/3	18/3	20/3
1	More Pratik Satish	P	P	A	P	P	P	P
2	Patil Sangram Maruti	A	P	P	P	P	P	P
3	Dingane Omkar Shivaji	P	P	P	A	P	P	P
4	Kumbhar Avishkar S.	P	A	P	P	P	P	P
5	Patel Shoyab Altaf	P	A	P	P	P	P	P
6	Patel Arshiya Tajuddin	P	P	A	P	P	P	P
7	Gadave Rutuja Rajendra	P	P	P	P	P	P	P
8	Dhavade Tejas Chandrakant	P	P	A	P	P	P	P
9	Devgan Vaishnavi A.	P	P	P	P	P	P	P
10	Velhal Rutvik S.	P	P	P	P	P	P	P
11	Madane Omkar M.	P	A	P	P	P	P	P
12	Shaikh Faizal G.	P	A	P	P	P	A	P
13	Desai Shivam A.	P	P	P	P	P	P	P
14	Bagwan Soheb Jabbar	P	a	P	P	P	P	P
15	Patel Aavej Vahid	P	P	P	P	P	P	P
16	Himanshu D. Afale	P	A	P	A	P	P	P
17	Tushar N. Jamale	P	A	P	P	P	P	P

18	Jadhav Balwant A.	P	A	P	P	P	P	P
19	Thorat Shubham S.	P	P	P	P	P	P	A



Mr. V. D. Yadav

Coordinator



Head of Mechanical Engg. Deptt.
Dr. Dautrao Aher College of Engineering
Banawadi-Karad.

Mr. S. J. Mulani

HOD MECH





G. K. Gujar Memorial Charitable Trust's
Dr. Ashok Gujar Technical Institute's
Dr. Daulatrao Aher College of Engineering, Karad
Accredited by NAAC with A Grade & ISO 9001-2008 Certified Institute
Training & Placement Cell

Date: 03/04/2023

Notice- Symbiosis- Electric Vehicle Training

All the students those who are interested for **Symbiosis Electrical Vehicle Technical Training** are hereby informed to note that, The Orientation process for selected candidates & selection process for interested candidates is scheduled on **06/04/2023** at **12:45 pm** at **auditorium**. All the students should report as per the schedule.

Name of the Training	Symbiosis- Electrical Vehicle Technical Training
Duration	2 Months Daily 3 to 4 Hrs.
Batch-1	Monday to Friday 3:00 pm to 6:00 pm Everyday & Saturday as per schedule
Venue	MECH Dept. Lab & Workshop
Refundable deposit	NA
Registration Link	https://forms.gle/LTerjUjKVmaaHqe3A
Technology	Symbiosis- Swabhiman- Electric Vehicle
Support from Symbiosis	Free of Cost Training, Project based Teaching, industry aligned curriculum and focus on Hands on skilling. & Placement Support
Mandatory for Students	90% attendance is compulsory for Theory & Practical

Prof. H. M. Kumbhar
Vice- Principal

Dr. Anwar M. Mulla
Principal

Cc:

Dean- Academics		IQAC	
HOD - EXTC		HOD - CSE	
HOD- MECH		HOD- CIVIL	

3/4/23



G. K. Gujar Memorial Charitable Trust

Dr. Ashok Gujar Technical Institute's

Dr. Daulatrao Aher College of Engineering, Karad

Symbiosys- Electric Vehicle Training Attendance

Trainer: Mr. Shubham Kirve

Venue:

Date: 19/5/2023 Time: 9:30 to

Batch: B1 B2

Sr.No	Complete Name	Mob. No.	Sign.
1	Mithun Y. Suryawanshi	9579887984	<i>[Signature]</i>
2	Shadage Susheel	9209590520	<i>[Signature]</i>
3	Shirdas Pramod P	9762115615	<i>[Signature]</i>
4	Ulhas Ghate	7499674412	<i>[Signature]</i>
5	Vibhav R. Vasu (Suryawanshi)	9067248267	V.R.S
6	Sangram Vasant Patil	8208537182	<i>[Signature]</i>
7	Sunny Sanjay Madane	7066126122	<i>[Signature]</i>
8	Mane Prashant Satish	7558555751	<i>[Signature]</i>
9	Omkar Bajarang Jagdale.	7385447699.	<i>[Signature]</i>
10	Vishwajeet Sanjay Jangam	8149551413	<i>[Signature]</i>
11	Prathamesh ramchandra mali	8856094965	<i>[Signature]</i>
12	Ashitash T. Thorat	8956431143	A
13			
14			
15			
16			
17			
18			
19			
20			
21			
22			
23			
24			
25			
26			



G. K. Gujar Memorial Charitable Trust

Dr. Ashok Gujar Technical Institute's

Dr. Daulatrao Aher College of Engineering, Karad

Symbios- Electric Vehicle Training Attendance

Trainer: Mr. Shubham Kirve

Venue: Okinawa (visit)

Date: 12/05/2023 Time: 10:30 am to 1:30 pm Batch: B1 & B2

Sr.No	Complete Name	Mob. No.	Sign.
1	Ulhas Ghate	7499674472	U. Ghate
2	Prem Vitthal Pawekar	9226458109	P. Pawekar
3	omkar Jagdale	7355447699	O. Jagdale
4	Rooshant Satish mame	7558555751	R. Mame
5	Sunny sanjay madane	7066126122	S. Madane
6	Mali pruthamesh Rajendra	8856095965	M. Rajendra
7	Mithun Y. Suryawanshi	9579887984	M. Suryawanshi
8	Vaibhav R Suryawanshi	9067248267	V. Suryawanshi
9	Thorat S. Vinayak	958350015	S. Thorat
10	Ashitash T. Thorat	8956431143	A. Thorat
11			
12			
13			
14			
15			
16			
17			
18			
19			
20			
21			
22			
23			
24			
25			
26			



G. K. Gujar Memorial Charitable Trust
Dr. Ashok Gujar Technical Institute's
Dr. Daulatrao Aher College of Engineering, Karad
Symbiosys- Electric Vehicle Training Attendance
Trainer: Mr. Shubham Kirve

Venue:

Date :

Time:

Batch:

Sr.No	Complete Name	Mob. No.	Sign.
1	Sangram Vasant Patil	8208537182	<i>Patil</i>
2	Sunny sanjay maddane	7066126122	<i>Maddane</i>
3	Mane Prashant Satish	7558555751	<i>Mane</i>
4	Mithun Vasant Suryawade	9579877983	<i>Mithun</i>
5	Vaibhav R. Suryawade	9067248267	<i>V.R.S</i>
6	Ashitosh T. Thorat	89566431143	<i>A</i>
7			
8			
9			
10			
11			
12			
13			
14			
15			
16			
17			
18			
19			
20			
21			
22			
23			
24			
25			
26			



G. K. Gujar Memorial Charitable Trust
Dr. Ashok Gujar Technical Institute's
Dr. Daulatrao Aher College of Engineering, Karad
Symbiosys- Electric Vehicle Training Attendance
Trainer: Mr. Shubham Kirve

Venue:

Batch: ~~B2~~ B1

Date: 16/05/2023 Time: 9:00

Sr.No	Complete Name	Mob. No.	Sign.
1	Ulhas Chate	7499674472	
2	Viki Waghmare	9834331152	
3	Omkar Jagdale	7385447699	
4	Sabil Shirwadkar		
5	Rohan Thombare		
6	Mane Prashant Satish	7558556761	
7	Sunny Sanjay Madane	7066126122	
8	Jangram Vasant Patil	8208539182	
9	Sagar Malawale	9146704967	
10	Sagar Anshy Malawale	8888494917	
11	H. B. Chavan		
12	Vinayak Thorat	9518350015	
13	Ashitosh T. Thorat	8956431143	
14			
15			
16			
17			
18			
19			
20			
21			
22			
23			
24			
25			
26			



G. K. Gujar Memorial Charitable Trust
Dr. Ashok Gujar Technical Institute's
Dr. Daulatrao Aher College of Engineering, Karad
Symbiosys- Electric Vehicle Training Attendance

Trainer: Mr. Shubham Kirve

Venue:

Date : 16/5/23 Time: 3pm to 5 pm.

Batch: B2

Sr.No	Complete Name	Mob. No.	Sign.
1	Gadgil Sushil H.	9309590570	
2	Shindas Pramod P	9762115615	
3	Prem Pavekar	9226458109	
4	Mithun Y. Suryawanshi	9579827983	
5	Vaibhav R. Suryawanshi	9061268267	
6			
7			
8			
9			
10			
11			
12			
13			
14			
15			
16			
17			
18			
19			
20			
21			
22			
23			
24			
25			
26			



G. K. Gujar Memorial Charitable Trust
Dr. Ashok Gujar Technical Institute's
Dr. Daulatrao Aher College of Engineering, Karad
Symbiosys- Electric Vehicle Training Attendance
Trainer: Mr. Shubham Kirve

Venue:

Batch: B1

Date: 15/4/23 Time: 9:00 to 12:00

Sr.No	Complete Name	Mob. No.	Sign.
1	Shirwadkar Sahil Pravin	992153802	Sahil
2	Waghmare, Viki Suresh	9639331152	Viki
3	Omkar Jagdale.	7385447699	Omkar
4	Ulhas Ghadge	7499674472	Ulhas
5	Prashant Seldish mame	7558555731	Prashant
6	Sunny Sanjay madane	7066126122	Sunny
7	Rajesh Malawade	9146704367	Rajesh
8	Akashy Malawade	8888494917	Akashy
9	H. B. Chavan		H. B. Chavan
10	Vinayak S. Thorat	9518350015	Vinayak
11	Ashitosh T. Thorat	8956431143	Ashitosh
12			
13			
14			
15			
16			
17			
18			
19			
20			
21			
22			
23			
24			
25			
26			



G. K. Gujar Memorial Charitable Trust
Dr. Ashok Gujar Technical Institute's
Dr. Daulatrao Aher College of Engineering, Karad
Symbiosys- Electric Vehicle Training Attendance
Trainer: Mr. Shubham Kirve

Date: 15/5/23 Time: 3pm to 5pm Venue: Batch: B2

Sr.No	Complete Name	Mob. No.	Sign.
1	Gadage Sushil	9309590590	[Signature]
2	Sangram Dasant Patil	8208537182	[Signature]
3	Jamale Tushar Nathuran	9870518219	[Signature]
4	Shirdas Pramod P	9762115615	[Signature]
5	Mali prathamesh Rajendra	8856094965	[Signature]
6	Mithun Y. Suryavanshi	9579887985	[Signature]
7	Vaibhav R. Suryavanshi	9067248267	[Signature]
8	Prem Vitthal Kavalkar	9226958109	[Signature]
9			
10			
11			
12			
13			
14			
15			
16			
17			
18			
19			
20			
21			
22			
23			
24			
25			
26			



G. K. Gujar Memorial Charitable Trust

Dr. Ashok Gujar Technical Institute's

Dr. Daulatrao Aher College of Engineering, Karad

Symbiosys- Electric Vehicle Training Attendance

Trainer: Mr. Shubham Kirve

Venue:

Date: 12/05/2023 Time:

Batch: B1 B2

Sr.No	Complete Name	Mob. No.	Sign.
1	Ulhas Ghadge	7499674472	Ghadge
2	Sangram Vasant Patil	8208537182	Patil
3	Vishwajeet Sanjay Jangam	8149551413	Jangam
4	Gayatri ⁿ Vijaykumar Jogadale	8262978597	Jogadale
5	Indrajit Satish Patil	8805308080	Patil
6	Sunny Sanjay madame	7066126122	madame
7	Shedage Purnita Dattatray	8999546665	Shedage
8	Patil Shreya G.	8237557228	Patil
9	Waghmare Viki. S	9834831152	Waghmare
10	mane Prashant Satish	7558555131	Mane
11	shirwadkar sanku Pravin	9921753602	Shirwadkar
12	Mali prathamesh Rajendra	8856099965	Mali
13	Chaudhary Sushil H.	9309590520	Chaudhary
14	Vaibhav R Sasyswajshi	9067248267	V.R.S
15	Mithun Y. Suryavanshi	9579887983	Mithun
16	Shivdas Pramod P	9762115615	Shivdas
17			
18			
19			
20			
21			
22			
23			
24			
25			
26			



G. K. Gujar Memorial Charitable Trust
Dr. Ashok Gujar Technical Institute's
Dr. Daulatrao Aher College of Engineering, Karad
Symbiosys- Electric Vehicle Training Attendance
Trainer: Mr. Shubham Kirve

Venue:

Batch: B1

Date: 11/05/2023 Time: 9:00 to 12:00

Sr.No	Complete Name	Mob. No.	Sign.
1	Ulhas Ghetge	7499674477	
2	Sunny Sanjay madane	7066126122	
3	Mame Prashant Satish	7558555751	
4	Shirwadkar Sabil Pravin	992253802	
5	Waghmare Viki Suresh	9839331152	
6	Arashy Nalawate	9888494917	
7	Rajuz Nalawate	9146704967	
8	H.B. Chawan		
9	Vinayak S. Thorat	9518350015	
10	Ashitosh T. Thorat	8956431143	
11			
12			
13			
14			
15			
16			
17			
18			
19			
20			
21			
22			
23			
24			
25			
26			



G. K. Gujar Memorial Charitable Trust

Dr. Ashok Gujar Technical Institute's

Dr. Daulatrao Aher College of Engineering, Karad

Symbiosys- Electric Vehicle Training Attendance

Trainer: Mr. Shubham Kirve

Venue:

Date : 11/05/23 Time: 3 pm to 5 pm

Batch: B2

Sr.No	Complete Name	Mob. No.	Sign.
1	Jamale Tushar Nethuram	9370518219	
2	Velhal Rutvik Sunil	9156992957	
3	Ghadage Sushil A.	9309590520	
4	Shedage Peanita D.	8999546665	
5	Patil Shreya G.	8239557228	
6	Shirdas Pramod P	9762115615	
7	Mithun Y. Suryavanshi	9579887984	
8	Vaibhav R. Suryavanshi	9067248267	
9	Prem Pavlekar	9226458009	
10			
11			
12			
13			
14			
15			
16			
17			
18			
19			
20			
21			
22			
23			
24			
25			
26			



G. K. Gujar Memorial Charitable Trust

Dr. Ashok Gujar Technical Institute's

Dr. Daulatrao Aher College of Engineering, Karad

Symbiosys- Electric Vehicle Training Attendance

Trainer: Mr. Shubham Kirve

Venue: Auditorium

Date: 10/05/23 Time: 9 am to 12 pm Batch: B1

Sr.No	Complete Name	Mob. No.	Sign.
1	Uhas Ghatge	7499674472	
2	Omkar Jagdale.	7985447699	
3	Vishwajit Jangam	8149551413	
4	Prem Pavekar	9326458109	
5	Sahil Pravin Shirwadkar	9921753802	
6	Akashy Nalawate	8888494917	
7	Sagar Nalawate	9146702967	
8	H. S. Charan		
9	Vinayak S. Thorat	9518350015	
10	Ashitosh T. Thorat	8956431143	A
11			
12			
13			
14			
15			
16			
17			
18			
19			
20			
21			
22			
23			
24			
25			
26			



G. K. Gujar Memorial Charitable Trust

Dr. Ashok Gujar Technical Institute's

Dr. Daulatrao Aher College of Engineering, Karad

Symbiosys- Electric Vehicle Training Attendance

Trainer: Mr. Shubham Kirve

Venue: Auditorium

Date: 09/05/23 Time: 9 am to 12 pm Batch: B1

Sr.No	Complete Name	Mob. No.	Sign.
1	Ulhas Ghadge	7499614472	
2	Omkar Jagadale	7385447699	
3	Rohan. Sukhdev Thombare	9372928387	
4	Sahil Pravin Shirwadkar	9921753802	
5	Vicky Suresh Waghmare	9372928387	
6	Vaibhav R. Suryawanshi	9067248767	V.R.S
7	Mithun Y. Suryawanshi	9579887985	
8	Jamale Kishore Nathuram	9370518219	
9	Ghadage Sushil A.	9309590510	
10	Prerona Pavekar	9226458109	
11	Sunny sanjay madane	7066126122	
12	Fatih Shreya G.	8237557208	
13	Rajeev Nalawate	9146704767	
14	Akushy Nalawate	8888494917	
15	H.B. Chavan		
16	Vinayak S. Thorat	9518350015	
17	Ashitosh T. Thorat	8956431143	A
18			
19			
20			
21			
22			
23			
24			
25			
26			



G. K. Gujar Memorial Charitable Trust

Dr. Ashok Gujar Technical Institute's

Dr. Daulatrao Aher College of Engineering, Karad

Symbiosys- Electric Vehicle Training Attendance

Trainer: Mr. Shubham Kirve

Venue: Auditorium

Date : 10/5/23

Time: 3 pm to 6 pm

Batch: B2

Sr.No	Complete Name	Mob. No.	Sign.
1	Ghadage Sushil A.	9209590520	[Signature]
2	Sangram V. Patil	8208539182	[Signature]
3	Sunny Sanjaymadane	7066126122	[Signature]
4	Mali prabhamesh Rajendra	8856094965	[Signature]
5	Patil Shroya G.	8239559228	[Signature]
6	Jamale Tushar Nathuram	9370518219	[Signature]
7	Nalawade Akshay Dinkar	8888494917	[Signature]
8	Shivdas Pramod. P	9762115615	[Signature]
9	Velhal Rutvik Sunil	9156992957	[Signature]
10	Mithun Y. Suryawanshi	9579887983	[Signature]
11	Vaibhav R Suryawanshi	9067248267	V.R.S
12	Patil Shroya G.	8239559228	[Signature]
13	Prem Pawankar	9226958109	P.V. Umbar
14			
15			
16			
17			
18			
19			
20			
21			
22			
23			
24			
25			
26			



G. K. Gujar Memorial Charitable Trust

Dr. Ashok Gujar Technical Institute's

Dr. Daulatrao Aher College of Engineering, Karad

Symbiosys- Electric Vehicle Training Attendance

Trainer: Mr. Shubham Kirve

Venue: Auditorium

Date: 09/05/23 Time: 3pm to 6pm

Batch: B2

Sr.No	Complete Name	Mob. No.	Sign.
1	Jadhav Aniket A.	8412094196	
2	shivedas Pramod P	9762115615	
3	Patil Shreya G.	8239559228	
4	Patil Sangram Vasant	8208537182	
5	Nakasele Anshu D	8888494917	
6	Jamale Tushar Nathuram	9370318219	
7	Vellhal Pratik Sunil	9156992957	
8	Mali prathamesh Rajendra	8856094965	
9	Prem Paverkar	9226958109	
10			
11			
12			
13			
14			
15			
16			
17			
18			
19			
20			
21			
22			
23			
24			
25			
26			



G. K. Gujar Memorial Charitable Trust

Dr. Ashok Gujar Technical Institute's

Dr. Daulatrao Aher College of Engineering, Karad

Symbiosys- Electric Vehicle Training Attendance

Trainer: Mr. Shubham Kirve

Venue: Auditorium

Date: 08/05/23

Time: 9am to 12pm

Batch: B1

Sr.No	Complete Name	Mob. No.	Sign.
1	omkar jagdale	7385447699	
2	Uhas Ghadge	7499674472	
3	prashant mane	7558555751	
4	Sabil Pravin shirsalkar	992253802	
5	Rohan sukhdar thore	9372928387	
6	vicky suresh waghmare	9372928367	
7	Patil Jangam Vasant	8208537182	
8	Sunny Sanjay roadane	7066126122	
9	Akashy Mulawale	8888494917	
10	Jagar Mulawale	9146704967	
11	H. B. Chavan		
12	Ashitosh T. Thorat	8956431143	A
13			
14			
15			
16			
17			
18			
19			
20			
21			
22			
23			
24			
25			
26			



G. K. Gujar Memorial Charitable Trust

Dr. Ashok Gujar Technical Institute's

Dr. Daulatrao Aher College of Engineering, Karad

Symbiosys- Electric Vehicle Training Attendance

Trainer: Mr. Shubham Kirve

Venue: Auditorium

Date : 08/05/2023 Time: 3 pm to 6 pm

Batch: B2

Sr.No	Complete Name	Mob. No.	Sign.
1	Patil Shreya Geeridhar	8289557228	Patil
2	Shedage Pranita Dattatray	8999546665	Shedage
3	Velhal Rutvik Sunil	9156992957	Rutvik
4	Nabawale AKShay Dinku	8888494917	Nabawale
5	Jamule Tushar Nathuram	9370518219	Jamule
6	Shirdas Pramod Prakash	8762115615	Shirdas
7	Jadhav Aniket A.	8412094196	Jadhav
8	Shedage Sushil A.	9209590620	Shedage
9	Patil Sangram Vasant	8208537182	Patil
10	Mali Prathamesh Rajendra	8856094965	Mali
11	Mithun Y. Suryavanshi	9579887781	Mithun
12	Vaibhav R. Suryavanshi	9867248267	V.R.S
13	A		
14			
15			
16			
17			
18			
19			
20			
21			
22			
23			
24			
25			
26			



G. K. Gujar Memorial Charitable Trust

Dr. Ashok Gujar Technical Institute's

Dr. Daulatrao Aher College of Engineering, Karad

Symbiosys- Electric Vehicle Training Attendance

Trainer: Mr. Shubham Kirve

Venue: Metallurgy lab.

Date: 05/05/23 Time: 9am to 12pm

Batch: B1 & B2

Sr.No	Complete Name	Mob. No.	Sign.
1	Mithun Y. Suryavanshi	9579887989	
2	Vaibhav R. Suryavanshi	9067248267	V.P.S
3	Mame Prashant Satish	7558555151	
4	madane sunny sanjay	7066126122	
5	Jamale Tushar Nathuram	9370518219	
6	Patil Shreya Giridhar.	8237557208	
7	Jagdale Gayatri Vijaykumar	8262918597	
8	Patil Indrajeet Satish.	8805308080	
9	Jangam Vishwajeet Sanjay	8149551413	
10	mali Prathmesh rajendra	8856094965	
11	Sangram Vasant Patil	8208537182	
12	Uhas Dadasaheb Ghetge	7499674472	
13	waghmare Viki Suresh	9834331152	
14	Shirwadkar satil Pravin	992753802	
15	Velhal Rutvik Sunil	9156992957	
16	Shivdas Pramod Prakash	9762115615	
17	Ashitosh T. Thorat	8956431143	A
18			
19			
20			
21			
22			
23			
24			
25			
26			



G. K. Gujar Memorial Charitable Trust

Dr. Ashok Gujar Technical Institute's

Dr. Daulatrao Aher College of Engineering, Karad

Symbiosys- Electric Vehicle Training Attendance

Trainer: Mr. Shubham Kirve

Venue: Auditorium

Date : 4/5/23

Time: 9 am to 12 pm

Batch: B1

Sr.No	Complete Name	Mob. No.	Sign.
1	Shirwadkar Sabil Pravin	9921258802	
2	Waghmare Viki Surech	9834331162	
3	mane Prashant Satish	7558555751	
4	malane sunny sanjay	7066126122	
5	Sangram Vasant Patil	8208537182	
6	Jamate Tushar Nethuram	9370518219	
7	Matawad Akashy	8888491917	
8	Matawad Akashy	9146704964	
9	H. B. Davan		
10	Ashitesh T. Thorat	8956431143	A
11			
12			
13			
14			
15			
16			
17			
18			
19			
20			
21			
22			
23			
24			
25			
26			



G. K. Gujar Memorial Charitable Trust

Dr. Ashok Gujar Technical Institute's

Dr. Daulatrao Aher College of Engineering, Karad

Symbiosys- Electric Vehicle Training Attendance

Trainer: Mr. Shubham Kirve

Venue: Auditorium

Date: 04/05/23 Time: 2 pm to 6 pm

Batch: B2

Sr.No	Complete Name	Mob. No.	Sign.
1	Jadhav Aniket A.	8412094196	<u>AJadhav</u>
2	Ghadage Sushil A.	9309590520	<u>Sushil</u>
3	Mithun Y. Suryavanshi	9579887985	<u>Mithun</u>
4	Vaibhav R. Suryavanshi	9067248267	<u>V.R.S</u>
5	Jamale Tushar Nishiram	9370518219	<u>Tushar</u>
6	Shivdas Pramod Prakash	9762115615	<u>Shivdas</u>
7	Patil Shreya Giridhar	8239557228	<u>Shreya</u>
8	Shedage Pranita Dattatray	8999546665	<u>Shedage</u>
9	Jagdale Gayatri Vijaykumar	8262978597	<u>Gayatri</u>
10	Patil Indrajeet Satish	8805308080	<u>Indrajeet</u>
11	Sawant Sairaj Suresh	7387741999	<u>Sairaj</u>
12	Jangam Vishwajeet Sanjay	8149551413	<u>Jangam</u>
13	Mali Prathamesh Rajendra	8856094965	<u>Mali</u>
14	Velhal Rutvik Sunil	9156992957	<u>Rutvik</u>
15	Neharule Akshay Dinkar	8888494917	<u>Neharule</u>
16	Prem Pavankar	9226958109	<u>Prem</u>
17			
18			
19			
20			
21			
22			
23			
24			
25			
26			



G. K. Gujar Memorial Charitable Trust

Dr. Ashok Gujar Technical Institute's

Dr. Daulatrao Aher College of Engineering, Karad

Symbiosys- Electric Vehicle Training Attendance

Trainer: Mr. Shubham Kirve

Venue: Auditorium

Date : 03/05/23 Time: 9am to 12pm

Batch: B1

Sr.No	Complete Name	Mob. No.	Sign.
1	Shirwadkar Sahil Pravin	992253802	Balku
2	Waghmare Viki Suresh	9839331152	Shubham Kirve
3	Mone Prashant Satish	7558555757	Shubham Kirve
4	Madane Sunny Sanjay	7066126122	Shubham Kirve
5	Shivdas Pramod P	9762115615	Shubham Kirve
6	Patil Sangram Vasant	8208537182	Balku
7	Ashitosh T. Thorat	8956431143	A
8			
9			
10			
11			
12			
13			
14			
15			
16			
17			
18			
19			
20			
21			
22			
23			
24			
25			
26			



G. K. Gujar Memorial Charitable Trust

Dr. Ashok Gujar Technical Institute's

Dr. Daulatrao Aher College of Engineering, Karad

Symbiosys- Electric Vehicle Training Attendance

Trainer: Mr. Shubham Kirve

Venue: Auditorium

Date: 03/05/23 Time: 3 pm to 6 pm

Batch: B2

Sr.No	Complete Name	Mob. No.	Sign.
1	Lagade Priti Anna	9139195520	Priti
2	Lagade Satyaam Anna	7356968555	Satyaam
3	Patil Shreya Giridhar	8237557228	Patil
4	Mithun Y. Suryavanshi	9579887993	Mithun
5	Vaibhav R. Suryavanshi	9067248267	V.R.S
6	Velhal Rutvik Sunil	9156992957	Rutvik
7	Jamale Tushar Nathuram	9370518219	Tushar
8	Jadhav Aniket A.	8412094196	Aniket
9	Nalawade Anshay Dinkar	8888494917	Nalawade
10	Mali Prathamesh Rajendra	9856094965	Pr. Mali
11	Poem Vitthal Pavankar	9226458104	Poem
12			
13			
14			
15			
16			
17			
18			
19			
20			
21			
22			
23			
24			
25			
26			



G. K. Gujar Memorial Charitable Trust

Dr. Ashok Gujar Technical Institute's

Dr. Daulatrao Aher College of Engineering, Karad

Symbiosys- Electric Vehicle Training Attendance

Trainer: Mr. Shubham Kirve

Venue: Auditorium

Date: 21/5/23

Time: 9 am to 12 pm

Batch: B1

Sr.No	Complete Name	Mob. No.	Sign.
1	shirwadkar Sachin Pravin	9921753802	
2	waghmare viki suresh	9834331162	
3	Mame Prashant Satish	7558555751	
4	madane Sunny Ganjy	7066126122	
5	shirdas Pramod P	9762115615	
6	Pabl Sangram Vasant	8208537182	
7	Vinayak S. Thorat	9518350015	
8	Ashitosh T. Thorat	8956431143	A
9			
10			
11			
12			
13			
14			
15			
16			
17			
18			
19			
20			
21			
22			
23			
24			
25			
26			



G. K. Gujar Memorial Charitable Trust

Dr. Ashok Gujar Technical Institute's

Dr. Daulatrao Aher College of Engineering, Karad

Symbiosys- Electric Vehicle Training Attendance

Trainer: Mr. Shubham Kirve

Venue: Auditorium

Date : 21/5/23

Time: 3pm to 6pm

Batch: D2

Sr.No	Complete Name	Mob. No.	Sign.
1	Mithun Y. Suryavanshi	9579887983	
2	Vaibhav R. Suryavanshi	9067248267	V.R.S
3	Ghadage Sushil A.	9309590520	
4	Jamale Tushar Nalhar	9870518219	
5	Nalwate Akshay Dinkar	8888494917	
6	Nalwate Jagan Sunil.	9146704967	
7	Jatyaam Jagade	9350968555	
8	Jadhav Aniket A.	8412094195	
9	Vishwajeet Sanjay Jangam	8149551413	
10	Prathamesh rajendra mali	8850094965	
11	Patil Shreya Giridhar.	8237557228	
12	Velhal Rutvik Sunil	9156992957	
13	Prem Pavakar	9226758109	
14			
15			
16			
17			
18			
19			
20			
21			
22			
23			
24			
25			
26			



G. K. Gujar Memorial Charitable Trust

Dr. Ashok Gujar Technical Institute's

Dr. Daulatrao Aher College of Engineering, Karad

Symbiosys- Electric Vehicle Training Attendance

Trainer: Mr. Shubham Kirve

Venue: Auditorium

Date : 27/4/23

Time: 9 am to 12 pm

Batch: B1

Sr.No	Complete Name	Mob. No.	Sign.
1	Waghmare Viki Suresh	9834331152	
2	Thombare Ronan Sukndev		
3	shirwadkar sahil Pravin		
4	Ulhas Dadasaheb Ghadge	7499674472	
5	mane Prashant Satish	7558555751	
6	madane Sunny Sunjay	7066126122	
7	Sangram Vasant Tatil	8208537182	
8	Nalavate Jayar Sunil	3146704967	
9	Nalavate Akshay Dinkar	8888494917	
10	H. B chavan .	9822328486	
11	Velhal Rutvik Sunil	9156992957	
12	Vinayak J. Thorat	9518350015	
13	Ashitesh T. Thorat	8956431143	A
14			
15			
16			
17			
18			
19			
20			
21			
22			
23			
24			
25			
26			



G. K. Gujar Memorial Charitable Trust

Dr. Ashok Gujar Technical Institute's

Dr. Daulatrao Aher College of Engineering, Karad

Symbiosys- Electric Vehicle Training Attendance

Trainer: Mr. Shubham Kirve

Venue: Auditorium

Date : 27/4/23 Time: 3 pm to 6 pm

Batch: B2

Sr.No	Complete Name	Mob. No.	Sign.
1	Jadhav Aniket Ananda	8412094196	ABJadhav
2	Ghadage Sushil	9309590570	Sushil
3	Vaibhav RSuryawanshi	9067248267	V.R.S
4	MHhim Y. Suryawanshi	9579887984	MHhim
5	Jamale Tushar Nathuram	9370518219	Tushar
6	Jangam Vishwajeet Sanjay	8149551413	Vishwajeet
7	Mali prathmesh rajendra	8856094965	Prmali
8	Shivdas Pramod Borkash	9762115615	Shivdas
9	Pavekar Prem	9226458109	Prem
10	Patil Shreya Giridhar.	8237557228	Patil
11	Shedage Pranita Dattatray	89990546665	Shedage
12	Prem		
13			
14			
15			
16			
17			
18			
19			
20			
21			
22			
23			
24			
25			
26			



G. K. Gujar Memorial Charitable Trust

Dr. Ashok Gujar Technical Institute's

Dr. Daulatrao Aher College of Engineering, Karad

Symbiosys- Electric Vehicle Training Attendance

Trainer: Mr. Shubham Kirve

Venue: Auditorium

Date : 26/4/23 Time: 9pm to 12pm

Batch: B1

Sr.No	Complete Name	Mob. No.	Sign.
1	WAGHMARE VIKI SURESH	9372928387	Chhaya.M
2	THOMBARE ROHAN SUKHDEV	9372928387	R.P.
3	SHIRWADKAR SAHIL PRAVIN	9372928387	Sahil.M
4	madane suany sanjay	7066126122	Smadane
5	Patil Jangam Vasant	8208537182	Patil
6	Mame Prashant Satish	7558555751	Patil
7	UlhasDadaSahab Ghatge	7499574472	Patil
8	Yishwajeet Sanjay Jangam	8149551413	Jangam
9	Patil Shreyo Giridhar	8297559228	Patil
10	Kalavate Nagar Sunil	9110704907	Patil
11	M.B. Chavan. nishi	9822328486	Chavan
12	Vinayak S. Thorat	9598350015	Thorat
13	Ashitash T. Thorat	8956431143	A
14			
15			
16			
17			
18			
19			
20			
21			
22			
23			
24			
25			
26			



G. K. Gujar Memorial Charitable Trust

Dr. Ashok Gujar Technical Institute's

Dr. Daulatrao Aher College of Engineering, Karad

Symbiosys- Electric Vehicle Training Attendance

Trainer: Mr. Shubham Kirve

Venue: Auditorium

Date: 28/11/23 Time: 3pm to 6pm

Batch: B2

Sr.No	Complete Name	Mob. No.	Sign.
1	Mithun Y. Suryawanshi	9579887984	
2	Vaibhav R. Suryawanshi	9067248267	V.R.S
3	Vishwajeet Sanjay Jangam	8149551413	
4	Jamale Tushar Nathuram	9370518219	
5	Nakwade Arvind Dinkur	8888494917	
6	Velhal Rutvik Sunil	9156992957	
7	Shivdas Pramod Prakash	9762115615	
8	Pavakar Prem Vitthal	9226958109	
9	Jadhav Aniket A.	8412094196	
10	Shedage Pranita D.	8999546665	
11	Patil Shreya Giridhar	8297557228	
12	Ehadage Sushil A.	9309590520	
13	Mali Pradhamesh Rajendra	8886096965	
14			
15			
16			
17			
18			
19			
20			
21			
22			
23			
24			
25			
26			



G. K. Gujar Memorial Charitable Trust

Dr. Ashok Gujar Technical Institute's

Dr. Daulatrao Aher College of Engineering, Karad

Symbiosys- Electric Vehicle Training Attendance

Trainer: Mr. Shubham Kirve

Venue: Auditorium

Date: 25/4/23 Time: 9am to 12pm

Batch: B1

Sr.No	Complete Name	Mob. No.	Sign.
1	Ulhas Dadasahab Chadge	7499674472	
2	Ratil Jangam Vasant	8208537182	
3	madane sunny sanjay	7066126122	
4	mane Prashant Satish	7558555751	
5	THOMBARE ROHAN SUKHDEV	9372928387	
6	SHIRWADKAR SAHIL PRAYIN	9921753802	
7	WAGHMARE VICKY SURESH	9372928387	
8	Vinayak S Thorat	9518350015	
9	Ashitosh T. Thorat	8950931193	
10	Nalante Jagan Suresh	9146704967	
11	H. B. Chauhan	9822528486	
12			
13			
14			
15			
16			
17			
18			
19			
20			
21			
22			
23			
24			
25			
26			



G. K. Gujar Memorial Charitable Trust

Dr. Ashok Gujar Technical Institute's

Dr. Daulatrao Aher College of Engineering, Karad

Symbiosys- Electric Vehicle Training Attendance

Trainer: Mr. Shubham Kirve

Venue: Auditorium

Date: 25/4/23 Time: 3 pm to 6 pm

Batch: B2

Sr.No	Complete Name	Mob. No.	Sign.
1	Jadhav Aniket Ananda	8412094196	Ashok
2	Mithun Y. Suryavanshi	9579887985	Mithun
3	Vaibhav Rajaram Suryavanshi	9067248267	V.R.S
4	Ghadage Sushil A	9309590520	Sushil
5	Velhat Rutvik Sunil	9156992957	Rutvik
6	Nalawade AKSHAY D	8988494917	Nalawade
7	Jamale Tushar Nathuram	9370518219	Tushar
8	Patil Shreya Giridhar	8237559228	Patil
9	Shedage Pranita Dattatray	8999546665	Pranita
10	Lagade Priti Anna	9139195520	Priti
11	Lagade Satyaam Anna	7350968535	Satyaam
12	Nalawade Rugar S.	9146704967	Nalawade
13	Patil Indrajeet Satish	8805308080	Patil
14	Jagdale Gayatri Vijaykumar	8262978597	Gayatri
15	Chavan Hanamant Bapurao	9822328486	Chavan
16	Shirdas Pramod Prakash	9762115615	Shirdas
17	Jungam Vishwajeet Sanjay	8149551413	Jungam
18	Mali Pradamesh Rajendra	8856094965	Mali
19			
20			
21			
22			
23			
24			
25			
26			



G. K. Gujar Memorial Charitable Trust

Dr. Ashok Gujar Technical Institute's

Dr. Daulatrao Aher College of Engineering, Karad

Symbiosys- Electric Vehicle Training Attendance

Trainer: Mr. Shubham Kirve

Venue:

Date: 24/04/23 Time: 9 am to 12 pm

Batch: B1

Sr.No	Complete Name	Mob. No.	Sign.
1	Bangsam Vasant Patil	8208537182	
2	Ulhas Dadasahab Ghadge	7499674472	
3	Viki Suresh Waghmare	9834331192	
4	Sanil Pravin Shirwadkar	992753602	
5	Shedage Pranita Dattatray	8999546665	
6	Patil Shreya Giridhar	8237557228	
7	Yethal Raktvik Sunil	9166992957	
8	Jamate Tushar Nethuram	9370518219	
9	Nalawale Rujar Sunil	9116704967	
10	Sunny Sanjay Madare	7066126122	
11	Ashitosh T. Thorat	8956431143	A
12			
13			
14			
15			
16			
17			
18			
19			
20			
21			
22			
23			
24			
25			
26			



G. K. Gujar Memorial Charitable Trust

Dr. Ashok Gujar Technical Institute's

Dr. Daulatrao Aher College of Engineering, Karad

Symbiosys- Electric Vehicle Training Attendance

Trainer: Mr. Shubham Kirve

Venue:

Date: 24/4/23 Time: 3pm to 6pm

Batch: B2

Sr.No	Complete Name	Mob. No.	Sign.
1	Jadhav Aniket Ananda	8412094196	
2	Lagade Priti Anna	9139195520	
3	Patil Gauri Tanaji	9579551051	
4	Pawar Peanita A.	9119405887	
5	Jadhav Sakshi D.	9767782008	
6	Lade Tanvi S.	7038130510	
7	Salave Dipti B.	9356564212	
8	Sanket Ghutigade	9016113038	
9	Shivdas Pramod Pokhri	9762115615	
10	Prem Vitthal Pawekar	9226458109	
11	Mithun Y. Suryawanshi	9579887984	
12	Vaibhav Rajaram Suryawanshi	9067248267	
13	Ghadage Sushil A.	9309590920	
14	Nelaode AKSraj P	8888494917	
15	Velhal Rutvik Sunil	9156992957	
16	Jamale Tushar Nathuram	9370518219	
17	Hannamant Beapurao Chevvan	9822328486	
18			
19			
20			
21			
22			
23			
24			
25			
26			



G. K. Gujar Memorial Charitable Trust

Dr. Ashok Gujar Technical Institute's

Dr. Daulatrao Aher College of Engineering, Karad

Symbiosys- Electric Vehicle Training Attendance

Trainer: Mr. Shubham Kirve

Venue: Auditorium

Date: 21/04/23 Time: 9am to 12pm

Batch: B1

Sr.No	Complete Name	Mob. No.	Sign.
1	Thorat Ashitosh Tamaji	8956431143	A
2	Mane Prashant Satish	7558555751	P
3	Madane Sunny Sanjay	7066126122	Shubham
4	Patil Sangram Vasant	8208537182	Patil
5	Vicky Suresh Waghmare	9834331152	Vicky
6	Sahil Pravin Shinwadkar	9921753802	Sahil
7	Rohan Sankar Thombare	9372928387	Rohan
8	Magade Prithi Anna	9139195520	Prithi
9	Malavate Jayant Sunil	9146704967	Malavate
10	Ashitosh T. Thorat	8956431143	A
11			
12			
13			
14			
15			
16			
17			
18			
19			
20			
21			
22			
23			
24			
25			
26			



G. K. Gujar Memorial Charitable Trust

Dr. Ashok Gujar Technical Institute's

Dr. Daulatrao Aher College of Engineering, Karad

Symbiosys- Electric Vehicle Training Attendance

Trainer: Mr. Shubham Kirve

Venue: Auditorium

Date : 21/04/23 Time: 03pm to 6pm

Batch: B2

Sr.No	Complete Name	Mob. No.	Sign.
1	Jadhav Aniket Anonda	842094196	<u>Abhik</u>
2	Ghadge Ulhas Ghadasahab	7499674472	<u>Ghadge</u>
3	Patil Indrajeet Satish	8805308080	<u>Patil</u>
4	Jagdale Gayatri Vijaykumar	8262978597	<u>Jagdale</u>
5	Jamale Tushar Nathuram	9370518219	<u>Jamale</u>
6	Ghadage Sushil A.	9309590520	<u>Ghadage</u>
7	Sawant Saigaj Suresh	7387741999	<u>Sawant</u>
8	Pavarkar Poon Vitthal	9226458199	<u>P.V. Pavarkar</u>
9	Lagade Prihi Anna	9139195520	<u>Prihi</u>
10	Pramod Prakash shirdas	9762115615	<u>Privedas</u>
11	Nikam Hrishikesh Kuldip	9284313241	<u>Nikam</u>
12	Hanuman Bapurao Chavhan	9122328486	<u>Chavhan</u>
13	Velhal Rutvik Sunil	9156992957	<u>Velhal</u>
14	Nalawade AKSantosh D	8888494917	<u>Nalawade</u>
15	Mithun Y. Suryawanshi	9579887989	<u>Mithun</u>
16	Vaibhav R. Suryawanshi	9867268267	<u>V.R.S</u>
17			
18			
19			
20			
21			
22			
23			
24			
25			
26			

G. K. Gujar Memorial Charitable Trust

Dr. Ashok Gujar Technical Institute's

Dr. Daulatrao Aher College of Engineering, Karad

Symbiosys- Electric Vehicle Training Attendance

Date : 20/04/2023 Venue: Auditorium

Time: 03:00 pm to 6:00 pm



Sr.No	Complete Name	Mob. No.	Education	Address	Sign.
1	Patil Sangram Vasant	8208537182	Diploma Mech.	A/P. Supare Tal. Karad	<i>[Signature]</i>
2	Thorat Vinayak Shankar	9518350015	B.Sc.	A/P. Karve Tal. Karad	<i>[Signature]</i>
3	Thorat Ashitosh Tanaji	8956431143	BE (E&T)	A/P. Inorunji, Karad	<i>[Signature]</i>
4	Ghadge Sushil A.	9309590520	B.E (Mech)	A/P. Karve, Karad	<i>[Signature]</i>
5	Jadhav Aniket Ananda	8412094196	S.Y. (B.Tech) me	At. Pat Karve, Karad	<i>[Signature]</i>
6	Ghetge Ulhas Dadasrao	7499674472	12 th	Peth Vadgaon	<i>[Signature]</i>
7	Shirsalkar Sahil Pravin	9921753502	B.E (Mech)	Karad	<i>[Signature]</i>
8	Thorgekar Rohan Suresh	9322928382	— " —	— " —	<i>[Signature]</i>
9	Waghmare Nikil Suresh	9839331152	— " —	— " —	<i>[Signature]</i>
10	Madane Sunny Sanjay	7066126122	B.A	Karad	<i>[Signature]</i>
11	Mane Prashant Satish	7558555751	B.A.	Karad	<i>[Signature]</i>
12	Bhosale Shubham Dilip	8237521820	F.Y. 2	Karad	<i>[Signature]</i>
13	Pavalkar Prem Vitthal	9226458109	B.Com III	Karad/Umbraj	<i>[Signature]</i>
14	Rutvik Sunil Velhal	9156992937	T.Y. Mech	AACEE Komasa	<i>[Signature]</i>
15	Tushar Nuthuram Jamale	9370518219	T.Y. Mech	Masur	<i>[Signature]</i>

Sr.No	Complete Name	Mob. No.	Education	Address	Sign.
16	Ganpat Sambhaji Chhutugade	9016113038	T-Y EITC	A/P Dhondawadi	Ganpat
17	Shivdas Pramod Prakash	9762115615	ITI	Parle	Shivdas
18	Sawant Sairaj Suresh	7387741999	T.Y. Mech	80, Shivaji Housing society Korad.	Sawant
19	Jogdale Gayatri Vijaykumar	8262978597	S.Y. EITC	A/P Masur	Jogdale
20	Patil Indrajeet Satish	8805308080	T.Y. Mech	A/P Hajarmachi	Patil
21	Lagade Prihi Anna	9189195820	B-Tech	A/P Shivajinagar gokh	Lagade
22	Nalawade Akshay Dinkar	8888494917	T.Y. Mech	A/P Parle	Nalawade
23	Nalawade Ragar Sunil	9146704967	T.Y. Mech	A/P Parle	Nalawade
24	Chavan Divya Raghunath	842628317	ENTC B.Tech	A/P Shere	Chavan
25	Chavan Komal Sanjay	9022953591	ENTC B.Tech	A/P - Shere	Chavan
26	Lokare Rutuja Pandurang	8554048674	ENTC B.Tech	A/P - Terawala	Lokare
27	Kudav Sakshi Kuber	9067347823	ENTC B.Tech	A/P - Yesuwal	Kudav
28	Mithun Y. Suryavanshi	9579887985	Mech.	A/P - M's Yedya	Mithun
29	Vaibhav R. Suryavanshi	9067248267	ITI	A/P - M - Vadgaon	V.R.S
30	Shedage Pranita Dattatray	8999546665	SE Mech	A/P - Rahimatpur	Shedage
31	Patil Shreya Giridhar	8237557228	S.Y. Mech	A/P Undale	Patil
32	Hanmant Bapurao Chavan	9822328486	DME/B.A	A/P Koparde	Hanmant
33					
34					



Mr. Shubham Kirve



G.K. Gujar Memorial Charitable Trust's
Dr. Ashok Gujar Technical Institute's,
Dr. Daulatrao Aher College of Engineering, Karad.
Vidyanagar Ext. Banawadi, Tal. Karad 415124, Dist. Satara, Maharashtra INDIA

Program Name: FDP on "MS-Office Basics"

DACOE/PRGM/COF-FRM-01

Department: Computer Science & Engineering

COF-FRM-01- Rev. No: 0

NOTICE

All BSH faculty members are hereby informed that Faculty development program on "MS-Office Basics" is scheduled from 17/4/2023 to 22/4/2023 at 3.00p.m to 5.00p.m. Attendance is mandatory for all the sessions.

Venue: Web Development Lab (CSE Dept.)







IQAC
Coordinator

Mentor

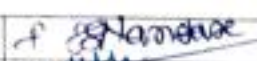
Principal 17/4/2023

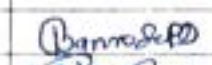
Principal

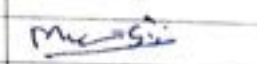
Cc:

DEAN ACADEMICS		HOD BSH	
DEAN R&D		HOD CIVIL	
DEAN INDUSTRY INSTITUTE		HOD CSE	
TPO		HOD E/NTC	
NAAC Coordinator		HOD MECH	
NBA Coordinator			



G.K. Gujar Memorial Charitable Trust's
DR. ASHOK GUJAR TECHNICAL INSTITUTE'S
DR. DAULATRAO AHIR COLLEGE OF ENGINEERING, KARAD
Department of Computer Science & Engineering

One Week Faculty Development Program on
"MS-Office Basics"
(17th-22th April 2023)

Schedule

Day / Date	Time	Topic	Resource Person
Monday 17-04-2023	3.00p.m-5.00p.m	MS-Word	Ms. D.R. Kamble
Tuesday 18-04-2023	3.00p.m-5.00p.m	MS-Word	Ms. A. R. Kadve
Wednesday 19-04-2023	3.00p.m-5.00p.m	MS-Power Point	Ms. S.D. Bandari
Thursday 20-04-2023	3.00p.m-5.00p.m	MS-Power Point	Mrs. A. H. Renushe
Friday 21-04-2023	3.00p.m-5.00p.m	MS-Excel	Ms. A. N. Mandale
Saturday 22-04-2023	3.00p.m-5.00p.m	MS-Excel	Mrs. P.M. Sheth

Ms. S. D. Bandari &
Mrs. A. H. Renushe
Co-ordinator

HOD CSE

Principal



G.K. Gujar Memorial Charitable Trust's
Dr. Ashok Gujar Technical Institute's,
Dr. Daulatrao Aher College of Engineering, Karad.
Vidyanagar Ext. Banawadi, Tal. Karad 415124, Dist. Satara, Maharashtra INDIA

Program Name: Two days Workshop on OOP

Date: 20/04/2023

DACOE/PRGM/COF-FRM-01

Department: COMPUTER SCIENCE & ENGINEERING

COF-FRM-01- Rev. No: 0

NOTICE

10/4/23

This is to inform SY CSE students that there is a Two days workshop on "Object Oriented Programming" under CSI Student branch.

Date: 21st April to 22nd April 2023

Time: 10:00 A.M. onwards

Venue: Class Room No.18

Participation: S.Y.B.tech (CSE) Students

* Note: Attendance is mandatory

IQAC
Coordinator

Mentor

Vice
Principal

Principal

Cc:

DEAN ACADEMICS		HOD BSH	
DEAN R&D		HOD CIVIL	
DEAN INDUSTRY INSTITUTE		HOD CSE	
TPO		HOD ENTC	
NAAC Coordinator		HOD MECH	
NBA Coordinator			



Attendance Sheet

Workshop on "Object Oriented Programming" under CSI Student branch

Sr. No	Roll No	Name Of Student	Session 1(Sign)	Session 2(Sign)
1)	22013	Harsh Vijay Gehange		
2)	22033	Maali Abhishek Bharat		
3)	22002	Bagwan Murooj Sajid		
4)	22021	Jangam Venkatesh Somnath		
5)	22056	Pise Prathmesh Anil		
5)	22068	Yelave Omkar Dattatray		
6)	22025	Kale Vishwajeet Vijay		
7)	22026	Katakalkewane Ritik		
8)	22027	Katakate Mayur		
9)	22009	Deshmukh Jagdish S.		
10)	22005	Chavan Prathmesh R		
11)	22045	Patil omkar krushnast		
12)	22046	Patil Rohan digambar		
13)	22008	Desai Kedar R		
14)	22011	Dixit Prathmesh R.		
15)	22046	velhal chinmay jagdish		

16.	22020	Jadhav Shivej Rajendra	<u>Shivej</u>	
17.	22028	Khedkar Utkarsh S	<u>Utkarsh</u>	
18.	22029	Ghufurkade Swarnil	<u>Swarnil</u>	
19.	22065	Sonawane Tanmay Raviraj	Sonawane	
20.	22040	Nalgure Shrutika Dhonraj	Nalgure	
21.	22035	Mane Vaibhavi Umesh	<u>N.U. Mane</u>	
22.	22030	Lade Vidya Dipak	<u>Vidya</u>	
23.	22051	Pawar Parati Uttam	<u>Parati</u>	
24.	22071	Babar Amruta Sadanand	<u>Amruta</u>	<u>Amruta</u>
25.	22060	Satpute Sakshi Ramchandra	<u>Satpute</u>	
26.	22003	Bhosale Sanika Dattatraya	<u>Bhosale</u>	<u>Bhosale</u>
27.	22006	Dange Jyoti Shrikant	<u>Jyoti</u>	<u>Jyoti</u>
28.	22022	Tunjwadkar Yogita Narayan	<u>Yogita</u>	<u>Yogita</u>
29.	22055	Pawar Shivani Pralhad	Pawar	
30.	22016	Injavale Sakshi Shivaji	<u>S.S. Injavale</u>	<u>S.S. Injavale</u>
31.	22015	Guram Shraddha Anandrao	<u>Guram</u>	
32.	22023	Kachar Rohini Sakhamam	<u>Rohini</u>	<u>Rohini</u>
33.	22031	Lokare Prajita Prakash	<u>Prajita</u>	Prajita
34.	22053	Pawar Nisha Baluram	<u>N.B. Pawar</u>	
35.	22041	Patel Auraju Samir	<u>A.S. Patel</u>	
36.	22062	Shinde Ashlesha Deepak	<u>Ashinde</u>	
37.	22064	Sonawale Bhavana Bhimrao	<u>Bhavana</u>	<u>Bhavana</u>



Attendance Sheet

Workshop on "Object Oriented Programming" under CSI Student branch

Sr. No	Roll No	Name Of Student	Session 1(Sign)	Session 2(Sign)
1)	22063	Shinde Neha Dilip		
2)	22072	Patil Vaishnavi Pravin		
3)	22012	Garkwad Namrata Babu		
4)	22010	Dhebe Rutuja Bajrang		
5)	22006	Dange Jyoti Shrikant		
6)	22054	Pawar Sakshi Bajirao		
7)	22077	Patil Vaishnavi Vishnu		
8)	22037	Mohite. Sakshi Ashok		
9)	22017	Jadhav Dhanashri Dhananjay		
10)	22024	Kadam Nandini Prashant		
11)	22032	Mohadik Sheeya Rahul Kumar		
12)	22001	Abdar Divya Lakshman		
13)	22004	Chovan Nilam Bhaskar		
14)	22018	Jadhav Manali Ramesh		
15)	22068	Yelave omkar Dattatray		
16)	22028	Khedkar Utkarsh Sudhir		

